

World Class Rigging Products

Product Catalogue | 2025/2026

OCEAN[®] Brand
Global Distribution
Securing the world



OCEAN[®]
RIGGING HARDWARE & PRODUCTS



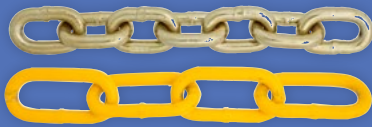

LIFTING & GENERAL PURPOSE CHAIN

G80 & G100 Overhead Lifting Chain	7	G80 Midlink Chain	10
G70 Transport Chain	8	G80 Lashing, Long Link & Short Link Chain	11
G80 Long Link Chain	8	G50 Stainless Steel	12
G30 Proof Coil Chain	9	Chain Sling Charts	12 - 13
G43 High Test Chain	10		

6



LASHING EQUIPMENT

Lever Load Binders	16	Ratchet Straps	21
Ratchet Binders	17 - 18 - 19	Ratchet Buckles	22
Tie Down Cargo Straps	19	Tie Down Webbing & Wire J Hooks	23
Truck Winch & Weld-On D-Rings	20		

15

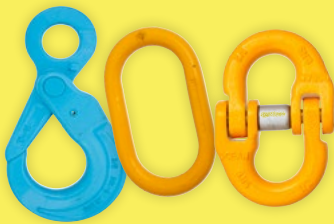

OCEAN G80 & G100 STEEL LIFTING COMPONENTS

G80 Master Links	25	G100 Trigger, Load Pin, and Pin & Sleeve Kits	41 - 42
G80 Connecting Links & Hooks	26 - 30	G80 Weld-On Bucket Hooks & Lifting Points	43 - 45
G80 Trigger, Load Pin, and Pin & Sleeve Kits	31	Lifting Eye Key Points	46 - 47
G80 Insulated Swivels & Coupling Components	32 - 34	Swivel Hoist Rings	48 - 51
G100 Master Links	34		
G100 Connecting Links & Hooks	36 - 41		

24



RIGGING HARDWARE & EQUIPMENT

Shackles	53 - 69	Twin Clevis & Quick Links, Snap & S Hooks	92 - 93
Turnbuckles	70 - 79	Swivels	94 - 100
Eye Bolts, Eye Nuts, & Pad Eyes	80 - 87	Wire Rope & Synthetic Blocks	101 - 111
DNV Master Links & Quad Assemblies	88 - 89	Load Cells	112 - 114
Pear Links, Master Links & Round Rings	90 - 91	Hooks	115 - 126

52



HOIST & LIFTING ACCESSORIES

Manual Chain Blocks & Lever Pullers	123 - 143	Vertical & Horizontal Plate Clamps	149 - 150
Wire Rope Winches	144	Cable Socks & Synthetic Rope Grabs	150 - 151
Permanent Magnet Lifters	145 - 146	Concrete Lifters	152
Trolleys & Beam Clamps	147 - 148	Drum Lifters	153

127



FALL ARREST

Carabiners, O-Ring & Fall Arrest Hooks	155 - 157
--	-----------

154



TOOLS

Hand Swagers & Cutters	159
Bolt Cutters	160

158



MARINE

Swivel Forerunners	163
Stud-Link & Open Link Chain	165-167
Kenter Shackles, Chain Stoppers & Pear Links	168 - 171
Triangle Plates, Recessed & Split Links	172 - 173
Round Rings and Lobster Swivels	174
Cleats & Hinges	175 - 176
Oar Locks and Knives	176 - 177

Bait Bags and Jars	177-178
Stenhouse Slips, & Washers	178
Anchors	179-188
Marine Hardware, Grapnels & Chain Chasers	189 - 193
Fenders & Deck Equipment	194-215

162



SLINGS

Wire Rope Slings - Bright	217 - 218
Wire Rope Slings - Galvanized	219 - 221
Wire Rope Sling Chart	222 - 223
Web Slings	224 - 225

Polyester Webbing	226
Round Slings	227 - 229
Twin Path	230

219



ROPE (SYNTHETIC & FIBER)

Manila Rope	233 - 234
Dyneema Rope	235 - 238
Soft Shackles - Dyneema	239
Polypropylene Ropes	240 - 242
Sail Twine	242

Nylon Rope	243 - 245
Sash Cord	246
Nylon & Polyester Double Braid	247 - 248
Fid, Pushers, Needles & Sail Palms	251 - 252

233



WIRE ROPE END TERMINATIONS

Rigging Equipment	256 - 258
Die Lube	259
Wire Rope Sleeves, Ferrules, Stops & Buttons	260 - 266
Marlin Spikes	266
Thimbles	267 - 271
Choker Buttons & Hooks	272

Go-No-Go Guages & Cable Joiners	272 - 273
Wire Rope Clips	274 - 276
Spelter Sockets	277 - 281
Socket Lock, Broom Degreaser & Socketing Putty	282 - 283
Swage, & Wedge Sockets	284 - 287

254

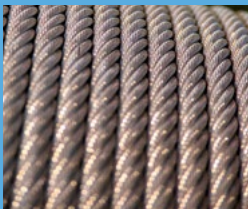

WIRE ROPE

Wire Rope Lubricant	289
7x7 & 7x19 GAC & PVC GAC	292 - 293
7x7, 7x19, 6x19, 6x26 Stainless Steel Wire	294
7x7 & 7x19 PVC Stainless Steel Wire	295
1x7 Stainless Seizing Wire	295
6x19 & 6x24 Fiber Core	296 - 297

6x26 Regular Swaged Wire Rope	297
6x19, 6x26, 6x36 IWRC	298 - 302
8x26, 18x19, 19x7, 6x25, 6x37 Wire Ropes	303 - 305
35x7, 8x19, 8x36 Wire Ropes	306 - 309

291

Head Office:
Oceanside Equipment Limited
12-181 Joseph Zatzman Drive
Dartmouth, Nova Scotia
Canada, B3B 1R5

Newfoundland Office:
Oceanside Equipment Limited
111 Glencoe Drive, Mount Pearl
Newfoundland and Labrador
Canada, A1N 4S7



CERTIFICATIONS | MEMBERSHIPS | APPROVAL PROGRAMS

DNV GL 2.7-1 - Type approval certificate(s) (S-8676, TAS000010N):



A worldwide accredited registrar and classification society. This type approval certificate requires a site audit of our manufacturing process for 2.7-1 Offshore Container Wire Rope Lifting Sling Sets. As well as compliance with; DNV GL 2.7-1 Containers, EN 12079-2, and EN 13414-1. Providing Oceanside authority to act on behalf of DNV to manufacture 2.7-1 offshore lifting sets for use with offshore containers.



HSE Achilles Green Band Approval Program - Offshore Oil & Gas Industry

A joint qualification system for supplier register and pre-qualification used by companies in the oil and gas industry. Approval of this system requires an in-depth QHSE audit. Providing clients/customers documented evidence of our Quality and HSE management system.

AWRF Member (Associated Wire Rope Fabricators (AWRF))



An authoritative representative body for 400+ independent fabricators, manufacturers and distributors of lifting and load securement devices. Providing solutions for wire rope, chain, hardware fittings, synthetic ropes, hoists, and rigging hardware as well as peer support, best practice advice, training library and technical reference material (ASME).



RIGGING HARDWARE & PRODUCTS

Oceanside Equipment Limited
 12-181 Joseph Zatzman Drive
 Dartmouth Nova Scotia, B3B 1R5
 Phone: 902-468-4844
 Fax: 902-468-2254
 Email: sales@oceansideequipment.ca
 Website: www.oceansideequipment.ca

INSPECTION & TEST CERTIFICATE

INSPECTION & TEST CERTIFICATE												
Certificate Number	0051853				Invoice Number	OCEAN-12						
Date	11/14/2023				Factory Order Number	2023/002700-001						
Purchase Order	PO306019											
Quantity	975				Batch Number	1GH						
Part Number	3-X-10CSH				Surface finish	Powder Coated						
Description	Hook, clevis sling, Gr100, 10mm 3/8" Ocean											
Working Load Limit (Pounds)	8,800				Hardness HRC	37、 38、 38						
Min Breaking force (Pounds)	35,200				Fatigue Test	20,000 cycles @1.5 WLL						
Actual Breaking Force (tonne)	16.49T、 16.42T、 16.15T、 16.2T				Magnetic Flux Test	100%						
Steel Code	C	Si	Mn	Cr	Ni	Mo	S	P	Al	Ti	Cu	
23MnNiMoCr54	0.220	0.180	1.270	0.520	1.010	0.530	0.009	0.010	0.031	/	/	
Manufactured and Inspected in accordance with EN1677												
Exceeds requirements of related ASME B30 Standards												
Manufactured in accordance with Quality Management System approved to ISO 9001 and 14001												
QA Signature: Gary Sullivan												

World Class Rigging Products

LIFTING & GENERAL PURPOSE CHAIN

G80 & G100 Overhead Lifting Chain.....	7
G70 Transport Chain.....	8
G80 Long Link Chain.....	8
G30 Proof Coil Chain.....	9
G43 High Test Chain.....	10
G80 Midlink Chain.....	10
G80 Lashing, Long Link & Short Link Chain.....	11
G50 Stainless Steel.....	12
Chain Sling Charts.....	12 - 13



CHAIN - OVERHEAD LIFTING, GRADE 80, OCEAN® BRAND

- Material: Grade 80, Alloy Steel
- Standard: EN 818-2 ASTM A391/A391M
- Finish: Black
- Design Factor: 4:1
- Identification: OC8, Batch Code



Trade Size (in)	WLL (lb)	Dimensions (mm)			Weight / 100 ft (lb)	Qty. / Drum (ft)	Full Drum	Cut Lengths	Part Number
		Dia.	Inside Length	Inside Width			Price / ft	Price / ft	
9/32	3500	7	21	9 – 10.5	70	800	4.59	5.50	28-7MM80LB
5/16	4500	8	24	10 – 12	92	550	5.70	6.84	28-8MM80LB
3/8	7100	10	30	12.5 – 15	142	400	8.65	10.38	6-3/8"G80
1/2	12 000	13	39	16.3 – 20	244	200	13.99	16.79	6-1/2"G80
5/8	18 100	16	48	20 – 24	356	150	23.72	28.46	6-5/8"G80
3/4	28 300	20	60	25 – 30	562	100	36.17	43.39	6-3/4"G80
7/8	34 200	22	66	28 – 33	720	164	48.82	58.59	6-7/8"G80
1	47 700	26	78	35 – 39	990	100	67.66	81.20	6-1"G80
1-1/4	72 300	32	96	40 – 42	1580	100	111.30	133.55	6-1-1/4"G80

Coming soon, G70, G80 and G100 Chain will be marked with OC, Grade, and PIC in intervals of every second link.

CHAIN - OVERHEAD LIFTING, GRADE 100, OCEAN® BRAND

- Material: Grade 100, Alloy Steel
- Standard: EN 818-2, ASTM A973
- Finish: Blue Powder Coat
- Design Factor: 4:1
- Identification: OC10, Batch Code



Trade Size (in)	WLL (lb)	Dimensions (mm)			Weight / 100 ft (lb)	Qty. / Drum (ft)	Full Drum	Cut Lengths	Part Number
		Dia.	Inside Length	Inside Width			Price / ft	Price / ft	
9/32	4300	7.4	22.1	10.4	74	500	6.62	7.94	44-9/32"G100
5/16	5700	8.4	25.7	12.7	104	500	8.32	9.98	44-5/16"G100
3/8	8800	10.2	31	14.5	148	500	11.73	14.08	44-3/8"G100
1/2	15 000	13.2	40.1	19.1	250	300	20.64	24.77	44-1/2"G100
5/8	22 600	16.3	49	22.1	379	200	31.76	38.11	44-5/8"G100
3/4	35 300	20.3	61.5	27.7	598	100	49.89	59.87	44-3/4"G100
7/8	42 700	22.4	68.6	32.5	775	100	70.98	85.18	44-7/8"G100
1	59 700	26	78	37	984	100	123.97	148.76	44-1"G100

Coming soon, G70, G80 and G100 Chain will be marked with OC, Grade, and PIC in intervals of every second link.

CHAIN - TRANSPORT, GRADE 70, OCEAN® BRAND

- Material: Grade 70, Carbon Steel
- Standard: EN 12195-3, ASTM A413
- Finish: Yellow Chromate
- Design Factor: 4:1
- Identification: OC7 Batch Code



Size (in)	WLL (lb)	Dimensions (mm)		Wt. / 100 ft (lb)	Qty. / Drum (ft)	Full Drum Price / ft	Cut Length Price / ft	Part Number
		Inside Length	Inside Width					
1/4	3150	31.5	9.7	62	800	3.34	4.01	73-1/4"G7
5/16	4700	32.8	11.2	101	550	4.54	5.44	73-5/16"G7
3/8	6600	35.0	14.0	138	400	6.07	7.28	73-3/8"G7
1/2	11 300	45.5	18.3	235	200	10.39	12.47	73-1/2"G7

Coming soon, G70, G80 and G100 Chain will be marked with OC, Grade, and PIC in intervals of every second link.

Compliant with National Safety Code Standard (NSC) 10 Part 1, Division 3, Section 11 (4)

"On and after January 1, 2011 a person shall not use a tie down or a component of a tie down to secure cargo to a vehicle unless it is marked by the manufacturer with respect to its working load limit."

The Tag is for 3/8" grade 70 chain which is now required for all tie down chains to meet the national safety standard. These chains are made in our shop to your requirements.



CHAIN - ALLOY LONG-LINK, GRADE 80, OCEAN® BRAND

- Material: Grade 80, Alloy Steel
- Finish: Painted Yellow
- Design Factor: 4:1



Size (mm)	Break Load (lb)	Dimensions (mm)		Weight / 100 ft (lb)	Qty. / Drum (ft)	Full Drum Price / ft	Cut Length Price / ft	Part Number
		Inside Length	Inside Width					
9	22 930	57	16	94	919	6.16	7.39	44-9MMLLC
11	34 175	66	18	141	656	9.07	10.88	44-11MMLLC
13	47 620	81	22	181	492	10.38	12.45	44-13MMLLC
16	72 315	100	26	289	328	15.70	18.84	44-16MMLLC
28	221 345	150	39	941	164	58.18	69.82	44-28MMLLC

To prevent the possibility of serious bodily harm: DO NOT EXCEED the working load limit of chain or components. NOT USE FOR OVERHEAD LIFTING OR HOISTING. DO NOT USE if the chain or components are visibly distorted or worn.

CHAIN - PROOF COIL, GRADE 30

- Material: Grade 30, Mild Carbon Steel
- Finish: Galvanized, ASTM A413
- Design Factor: 4:1



Trade Size (in)	WLL (lb)	Dimensions (inches)			Weight / 100 ft (lb)	Qty. / Drum (ft)	Full Drum Price / ft	Cut Length Price / ft	Part Number
		Dia.	Inside Length	Inside Width					
3/16	800	0.22	0.98	0.30	40	750	2.13	2.56	6-3/16"30G
1/4	1300	0.28	1.24	0.38	66	800	3.02	3.63	6-1/4"30G
5/16	2000	0.32	1.29	0.44	86	550	4.44	5.33	6-5/16"30G
3/8	2400	0.37	1.45	0.63	142	400	5.87	7.04	6-3/8"30G
1/2	4500	0.51	2.05	0.87	242	200	8.53	10.24	6-1/2"30G
5/8	6900	0.63	2.20	0.79	357	150	10.07	12.09	6-5/8"30G
3/4	10 600	0.79	2.76	0.98	560	100	21.14	25.41	6-3/4"30G
1	13 950	0.98	3.58	1.25	924	50	41.36	49.63	6-1"30G

CHAIN - PROOF COIL, GRADE 30

- Material: Grade 30, Mild Carbon Steel
- Finish: Self Coloured, ASTM A413
- Design Factor: 4:1



Trade Size (in)	WLL (lb)	Dimensions (inches)			Wt. / 100 ft (lb)	Qty. / Drum (ft)	Full Drum Price / ft	Cut Length Price / ft	Part Number
		Dia.	Inside Length	Inside Width					
1/4	1300	0.28	1.24	0.38	66	800	2.01	2.42	6-1/4"30B
5/16	2000	0.30	1.29	0.44	86	550	3.08	3.54	6-5/16"30B
3/8	2400	0.39	1.45	0.63	142	400	4.50	5.40	6-3/8"30B
1/2	4500	0.49	2.05	0.87	242	200	8.65	9.81	6-1/2"30B
5/8	6900	0.61	2.20	0.79	357	150	12.66	14.55	6-5/8"30B

CHAIN - SELF COLOURED, HIGH TEST, GRADE 43

- Material: Grade 43, Carbon Steel
- Finish: Self Colored, ASTM A413
- Design Factor: 4:1



Trade Size (in)	WLL (lb)	Dimensions (inches)			Weight / 100 ft (lb)	Qty. / Drum (ft)	Full Drum Price / ft	Part Number
		Dia.	I.L.	I.W.				
3/8	5400	0.38	1.36	0.58	132	400	4.40	44-3/8"G43
1/2	9200	0.53	1.70	0.75	237	200	7.70	44-1/2"G43

CHAIN - MID-LINK FISHING, GRADE 80

- **High Strength alloy steel with grade 80 strengths**
- Material: Grade 80, Alloy Steel
- Finish: Self Colour
- Design Factor: 4:1



Size (in)	WLL (lb)	Dimensions (inches)		Wt. / 100 ft (lb)	Qty. / Drum (ft)	Full Drum Price / ft	Cut Length Price / ft	Part Number
		Inside Legth	Inside Width					
1/2	11 900	2.05	0.83	230	200	12.21	14.65	73-1/2"CML
5/8	18 100	2.52	0.94	340	150	15.39	18.46	73-5/8"CML
3/4	25 500	3.00	1.16	510	100	22.14	26.56	73-3/4"CML
7/8	34 162	3.46	1.20	631	100	40.61	48.73	73-7/8"CML

To prevent the possibility of serious bodily harm: DO NOT EXCEED the working load limit of chain or components. NOT USE FOR OVERHEAD LIFTING OR HOISTING. DO NOT USE if the chain or components are visibly distorted or worn.

CHAIN - LONG-LINK LASHING, GRADE 80

- Material: Grade 80
- Finish: Galvanized
- Design Factor: 4:1



Trade Size (in)	Break Load (lb)	Dimensions (mm)			Wt. / 100 ft (lb)	Qty. / Drum (ft)	Price / ft	Part Number
		Dia.	Inside Length	Inside Width				
1/2	40 000	13.5	82	27	222	400	13.33	6-13.5MMGLC

CHAIN - ALLOY LONG-LINK, GRADE 80, TRYGG®

- Material: Grade 80, Alloy Steel
- Finish: Self Coloured
- Design Factor: 4:1



Size (mm)	Break Load (lb)	Dimensions (mm)		Weight / 100 ft (lb)	Qty. / Drum (ft)	Full Drum	Cut Length	Part Number
		Inside Length	Inside Width			Price / ft	Price / ft	
11	34 170	66	18	141	656	5.67	6.80	155-11MMLLSCC

CHAIN - ALLOY SHORT-LINK, GRADE 80, TRYGG®

- Material: Grade 80, Alloy Steel
- Finish: Self Coloured
- Design Factor: 4:1



Size (in)	Break Load (lb)	Dimensions (mm)		Weight / 100 ft (lb)	Qty. / Drum (ft)	Full Drum	Part Number
		Inside Length	Inside Width			Price / ft	
5/8	72 315	48	22	382	328	14.86	155-16MMSLC

CHAIN - STAINLESS, GRADE 50

- **Rated for Overhead Lifting**
- Material: Grade 50, 316L Stainless Steel
- Finish: Stainless Steel
- Design Factor: 4:1



Trade Size (in)	WLL (lb)	Dimensions (mm)			Qty. / Drum (ft)	Price / ft	Part Number
		Dia.	Inside Length	Inside Width			
3/16	1308	5.4	24.7	7.6	800	16.68	6-3/16G50SS
9/32	2200	7.0	22	10.5	800	27.16	6-9/32G50SS
5/16	2700	8	24	10	550	30.66	6-5/16G50SS
3/8	4400	10	30	14.5	400	42.02	6-3/8G50SS
1/2	7300	13	39	19	200	65.98	6-1/2G50SS
5/8	11240	16	46	21	250	98.43	6-5/8G50SS

CHAIN SLINGS - SLING CHART, CHAIN

GRADE 80 / GRADE 100 CHAIN SLINGS MADE TO ORDER!

Simply call and tell us what size, type and grade you are looking for and we will get back to you right away with a competitive price. Chain slings are fully certified and proof tested.

See Chain sling charts below for Working Load Limits.



First Symbol (basic type)

- S - Single chain sling
- C - Single choker chain sling with a standard end link on each end, no hooks
- D - Double branch chain sling
- T - Triple branch chain sling
- Q - Quadruple branch chain sling
- A - Proceeds symbol if shortening clutches are used

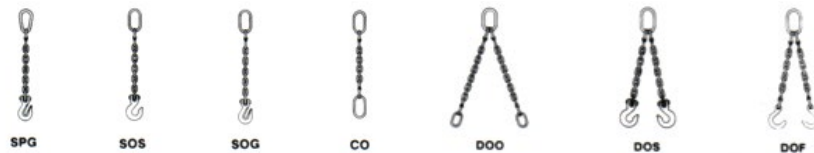

Second Symbol (type of master/end link)

- O - Oblong master link of standard dimensions
- P - Pear shaped master link









Third Symbol (type of hook)

- S - Sling hook
- G - Grab hook
- F - Foundry hook

To prevent the possibility of serious bodily harm: DO NOT EXCEED the working load limit of chain or components. NOT USE FOR OVERHEAD LIFTING OR HOISTING. DO NOT USE if the chain or components are visibly distorted or worn.

GRADE 80 CHAIN SLING - Working Load Limits Rated in Pounds

Chain Grade 80 Size		Single Leg (lb)	Two Leg (lb)			Three & Four Leg (lb)		
								
Inch	mm	90°	60°	45°	30°	60°	45°	30°
1/4-9/32	7	3500	6100	4900	3500	9100	7400	5200
5/16	8	4500	7800	6400	4500	11700	9500	6800
3/8	10	7100	12300	10000	7100	18400	15100	10600
1/2	13	12000	20800	17000	12000	31200	25500	18000
5/8	16	18100	31300	25600	18100	47000	38400	27100
3/4	20	28300	49000	40000	28300	73500	60000	42400
7/8	22	34200	59200	48400	34200	88900	72500	51300
1	26	47700	82600	67400	47700	123900	101200	71500
1-1/4	32	72300	125200	102200	72300	187800	153400	108400

GRADE 100 CHAIN SLING - Working Load Limits Rated in Pounds

Chain Grade 100 Size		Single Leg (lb)	Two Leg (lb)			Three & Four Leg (lb)		
								
Inch	mm	90°	60°	45°	30°	60°	45°	30°
1/4-9/32	7	4300	7400	6100	4300	11200	9100	6400
5/16	8	5700	9900	8100	5700	14800	12100	8500
3/8	10	8800	15200	12400	8800	22900	18700	13200
1/2	13	15000	26000	21200	15000	39000	31800	22500
5/8	16	22600	39100	32000	22600	58700	47900	33900
3/4	20	35300	61100	49900	35300	91700	74900	52950
7/8	22	42700	74000	60400	42700	110900	90600	64000
1	26	59700	103400	84400	59700	155100	126000	89550

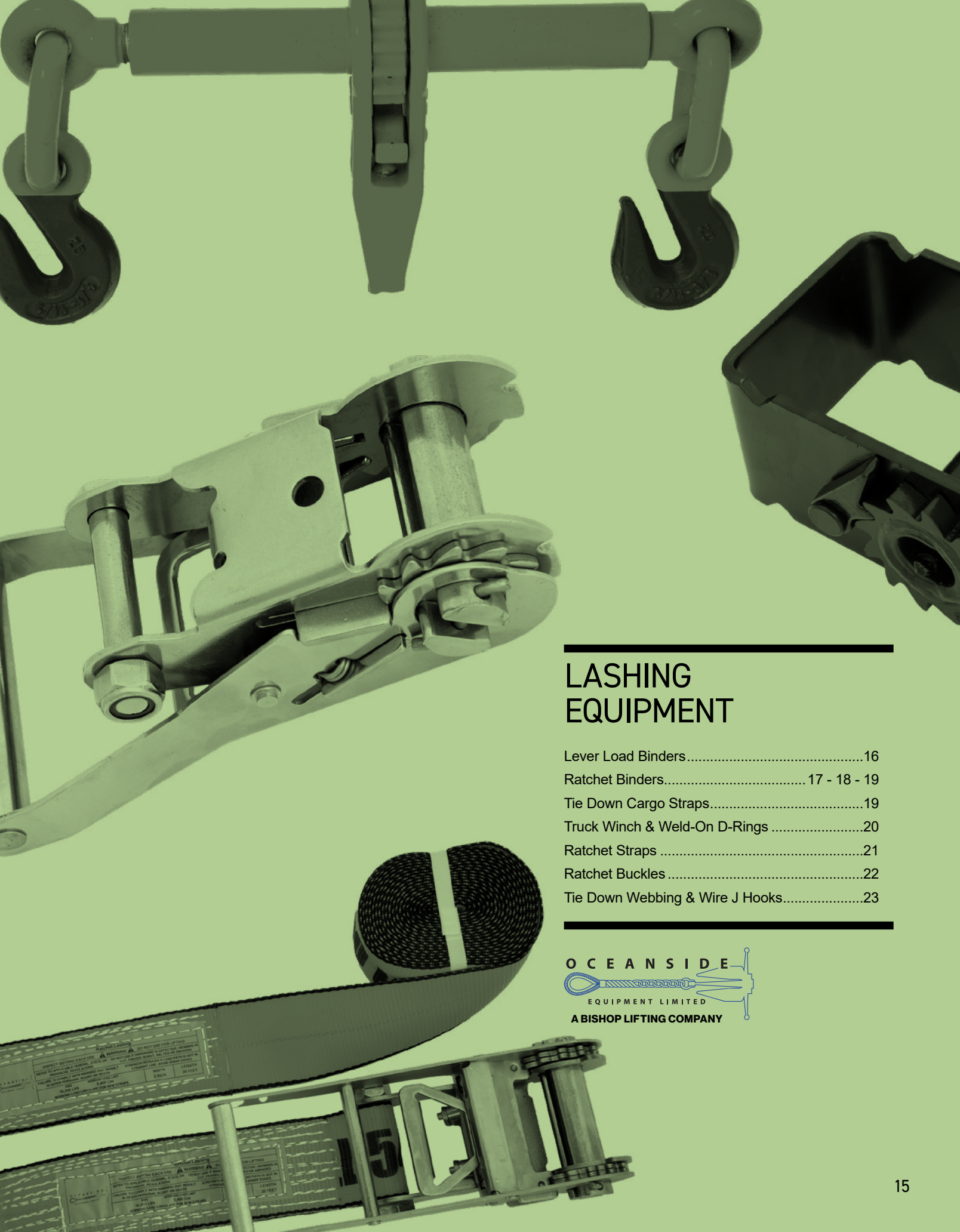

LASHING EQUIPMENT

- Lever Load Binders.....16
- Ratchet Binders..... 17 - 18 - 19
- Tie Down Cargo Straps.....19
- Truck Winch & Weld-On D-Rings20
- Ratchet Straps21
- Ratchet Buckles22
- Tie Down Webbing & Wire J Hooks.....23

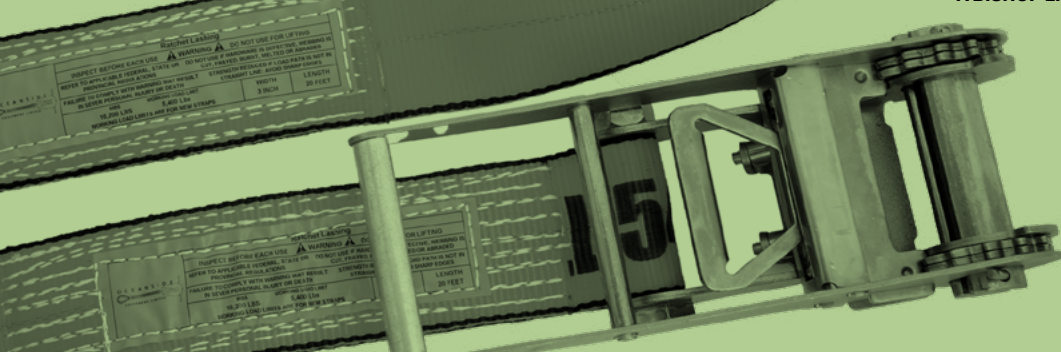

LOADBINDER - LEVER

Ball & Socket swivel joint at hook assembly permits a straight line pull
 Before use, oil ball & socket for longer life

- Material: Forged Steel, Quenched & Tempered
- Standard: EN 12195-3
- Finish: Painted Yellow
- Design Factor: 3.5:1
- Identification: Trademark, Size/WLL, Batch Code

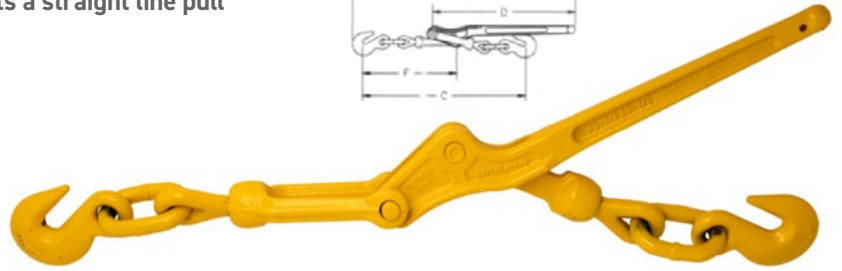
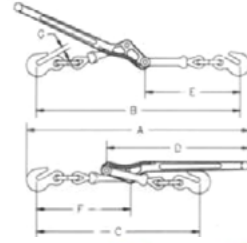

Chain Size (in)	WLL (lb)	Ult. Tension (lb)	Weight (lb)	Inside Measures (in)							Qty./Box	Price / ea.	Part Number
				A	B	C	D	E	F	G			
1/4 - 5/16	2600	9100	3.3	18.50	17.18	14.43	11.50	8.25	8.12	0.37	10	44.37	6-1/4-5/16LB
5/16 - 3/8	5400	19 250	7.02	24.13	22.13	17.88	16.00	10.38	10.38	0.50	5	59.21	6-5/16-3/8LB
3/8 - 1/2	9200	33 000	12.47	28.75	25.75	21.25	18.69	12.31	12.38	0.63	5	104.51	6-3/8-1/2LB

LOADBINDER - LEVER, BX

BX-600 / BX-800

Load Binder Lever with Kickback Resistance

Ball & Socket swivel joint at hook assembly permits a straight line pull.
 Before use, oil ball & socket for longer life.

- Material: Forged Steel, Quenched & Tempered
- Standard: EN 12195-3
- Finish: Painted Yellow
- Design Factor: 3.5:1
- Identification: Trademark, Size/WLL, Batch Code



Binder Number	Chain Size (in)	WLL (lb)	Lever Length (in)	Take up (in)	Weight (lb)	Qty./Box	Price / ea.	Part Number
BX-600	5/16	4700	12-1/2	4-1/2	8.6	5	84.08	6-BX600
BX-600	3/8	5400						
BX-800	3/8	6600	16	4-1/2	13.4	4	125.83	6-BX800
BX-800	1/2	9200						

Failure to use binders properly may result in serious injury or death. DO NOT operate load binder while standing on the load. Keep yourself out of the path of the moving handle and loose chain lying on the handle. You must be familiar with regulations regarding size and number of chain systems required for securing loads. Always consider the safety of nearby workers as well as yourself when using load binder. While under tension, load binder must not bear against an object, as this will cause side load. Do not use handle extender. Do not attempt to open or close the binder with more than one person. **Load binders not stored with both hooks secured could potentially back out under road vibrations.**

LOADBINDER - RATCHET, HS

Matches the Working Load Limit of Grade 100 Chain for both sizes

- Material: Forged Steel, Quenched & Tempered, Gr 100
- Standard: EN 12195-3, WSTDA-T-6
- Finish: Powder Coated Yellow & Blue
- Design Factor: 3:1
- Identification: Trademark, Size/WLL, Batch Code

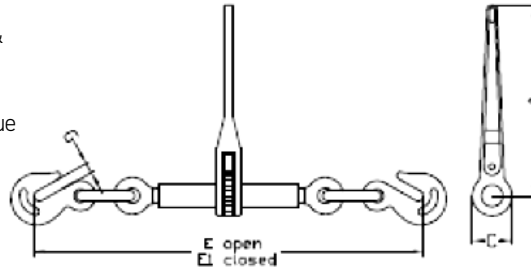

Chain Size (in)	WLL (lb)	Proof Load (lb)	Weight (lb)	Dimensions (in)					Qty. / box	Price / ea.	Part Number
				A	C	E1	E	G			
5/16 - 3/8	8800	17 600	10.95	13.98	2.56	23.54	29.88	0.50	4	96.08	6-5/16-3/8RBHS
3/8 - 1/2	15 000	30 000	11.69	13.98	2.56	24.75	30.95	0.65	5	106.07	6-3/8-1/2RBHS

- Meets or exceeds DOT and CVSA Cargo Securement Tie-Down Guideline

LOADBINDER - RATCHET

- Material: Forged Alloy Steel, Quenched & Tempered
- Standard: EN 12195-3, WSTDA-T-6
- Finish: Painted Yellow
- Design Factor: 3.5:1
- Identification: Trademark, Size/WLL, Batch Code

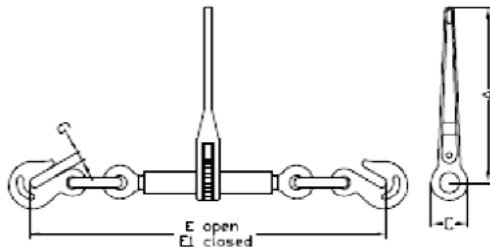

Chain Size (in)	WLL (lb)	Proof Load (lb)	Weight each (lb)	Dimensions (in)					Pcs / box	Price / ea.	Part Number
				A	C	E1	E	G			
5/16 - 3/8	6600	13 200	10.56	13.98	2.56	23.54	29.88	0.50	5	83.12	6-5/16-3/8RB
3/8 - 1/2	9200	18 400	11.24	13.98	2.56	23.74	30.24	0.65	5	88.65	6-3/8-1/2RB
1/2 - 5/8	13 000	26 000	15.83	13.98	2.56	27.17	33.86	0.73	4	101.12	6-1/2-5/8RB
5/8 - 3/4	20 000	40 000	28.60	13.98	2.56	29.29	31.61	0.93	2	296.18	6-5/8-3/4RB

Failure to use binders properly may result in serious injury or death. DO NOT operate load binder while standing on the load. Keep yourself out of the path of the moving handle and loose chain lying on the handle. You must be familiar with regulations regarding size and number of chain systems required for securing loads. Always consider the safety of nearby workers as well as yourself when using load binder. While under tension, load binder must not bear against an object, as this will cause side load. Do not use handle extender. Do not attempt to open or close the binder with more than one person. **Load binders not stored with both hooks secured could potentially back out under road vibrations.**

NEW LOADBINDER - FOLDING BINDER - RATCHET

- Material: Forged Alloy Steel, Quenched & Tempered
- Standard: EN 12195-3, WSTDA-T-6
- Finish: Painted Yellow
- Design Factor: 4:1
- Identification: Trademark, Size/WLL, Batch Code

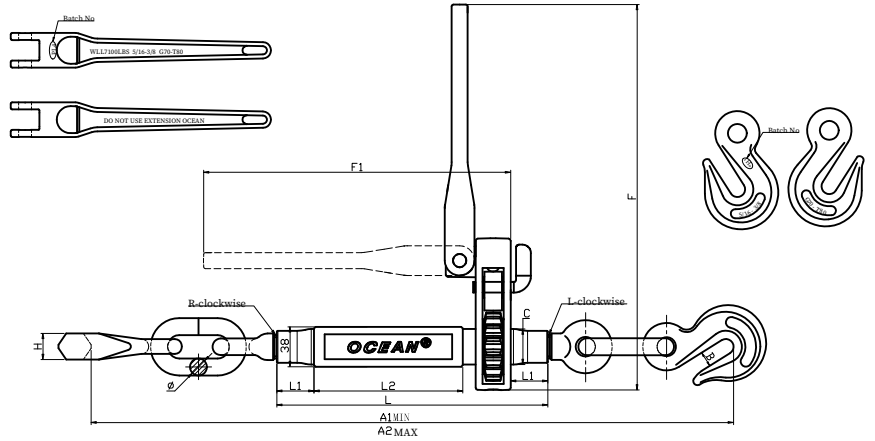

Chain Size (in)	WLL (lb)	Proof Load (lb)	Weight (lb)	Dimensions (in)											Qty. / Box	Price / ea.	Part Number
				B	C	L	L1	L2	F	F1	ϕ	H	A1	A2			
5/16-3/8	7100	14200	11.24	0.51	1.34	10.04	1.38	5.51	14.25	11.22	0.55	0.89	22.64	28.94	4	94.22	6-5/16-3/8FB
3/8-1/2	12000	24000	13.00	0.67	1.34	10.04	1.38	5.51	14.25	11.22	0.63	0.96	23.43	29.92	4	110.14	6-3/8-1/2FB
1/2-5/8	18100	36200	16.09	0.75	1.44	10.24	1.38	5.51	14.25	11.22	0.79	1.12	26.38	32.87	2	165.52	6-1/2-5/8FB



Failure to use binders properly may result in serious injury or death. DO NOT operate load binder while standing on the load. Keep yourself out of the path of the moving handle and loose chain lying on the handle. You must be familiar with regulations regarding size and number of chain systems required for securing loads. Always consider the safety of nearby workers as well as yourself when using load binder. While under tension, load binder must not bear against an object, as this will cause side load. Do not use handle extender. Do not attempt to open or close the binder with more than one person. **Load binders not stored with both hooks secured could potentially back out under road vibrations.**

LOADBINDER - RATCHET, T-HANDLE

Matches the Working Load Limit of Grade 100 Chain

- Material: Forged Steel, Quenched & Tempered
- Standard: EN 12195-3, WSTDA-T-6
- Finish: Painted Yellow & Blue
- Design Factor: 3:1
- Identification: Trademark, Size/WLL

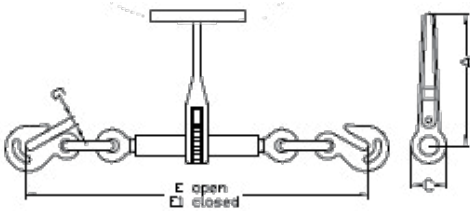

Chain Size (in)	WLL (lb)	Proof Load (lb)	Weight each (lb)	Dimensions (in)					Pcs / box	Price / ea.	Part Number
				A	C	E1	E	G			
5/16 - 3/8	8800	17 600	12.30	8.86	2.56	22.64	28.94	0.50	4	117.88	6-5/16-3/8RBHST

Failure to use binders properly may result in serious injury or death. DO NOT operate load binder while standing on the load. Keep yourself out of the path of the moving handle and loose chain lying on the handle. You must be familiar with regulations regarding size and number of chain systems required for securing loads. Always consider the safety of nearby workers as well as yourself when using load binder. While under tension, load binder must not bear against an object, as this will cause side load. **Do not use handle extender. Do not attempt to open or close the binder with more than one person.**

TIE DOWN CARGO STRAP - CHAIN ASSEMBLY

- Material: Grade 70, Carbon Steel, Polyester
- Standard: EN 12195-2,3,WSTDA-T-1
- Finish: UV Protection, Yellow Chromate
- Design Factor: 3:1
- Identification: Trademark, Size/WLL



Size		WLL (lb)	Price / ea.	Part Number
Width (in)	Length (ft)			
3	30	5400	49.91	126-3\"X30\"WC

Compliant with National Safety Code Standard (NSC) 10 Part 1. Division 3, Section 11 (4)

“On and after January 1, 2011 a person shall not use a tie down or a component of a tie downtown secure cargo to a vehicle unless it is marked by the manufacturer with respect to its working load limit.”

WINCH - TRUCK, #5820

- Designed for use with 3" strapping
- Material: Steel Plate
- Finish: Black Painted
- Design Factor: 3:1

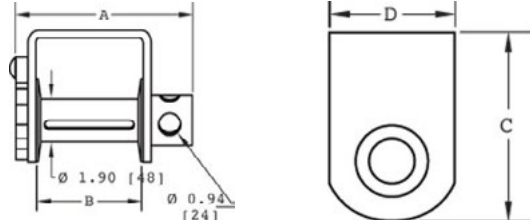

Type	Dimensions (in)				Weight (lb)	Price / ea.	Part Number
	A	B	C	D			
#5820	7.75	4.88	7.58	4.00	10.7	63.40	6-#5820TW

RING - WELD-ON D-RING TIE DOWN

- Rated in Metric Ton(s)

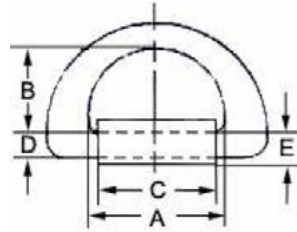

Size (mm)	MBS (t)	Dimensions (mm)					Weight (kg)	Price / ea.	Part Number
		A	B	C	D	E			
27	50	155	90	130	27	32	4.41	123.55	6-DRING

TIE DOWN CARGO STRAP - RATCHET

- **WLL marked along entire length of webbing.**
- Material: Grade 70, Carbon Steel, Polyester
- Standard: EN 12195-2,3, WSTDA-T-1
- Finish: UV Protection, Yellow Chromate
- Design Factor: 3:1
- Identification: Trademark, Size/WLL



Width (in)	Size		MBS (lb)	WLL (lb)	Price / ea.	Part Number
	Length (ft)					
2	10		10 000	3335	24.58	126-2"X10'RWH
2	15		10 000	3335	26.72	126-2"X15'RWH
2	20		10 000	3335	28.82	126-2"X20'RWH
2	25		10 000	3335	30.93	126-2"X25'RWH
2	30		10 000	3335	34.42	126-2"X30'RWH

TIE DOWN CARGO STRAP - RATCHET

- **WLL marked along entire length of webbing.**
- Material: Grade 70, Carbon Steel, Polyester
- Standard: EN 12195-2,3, WSTDA-T-1
- Finish: UV Protection, Yellow Chromate
- Design Factor: 3:1
- Identification: Trademark, Size/WLL



Width (in)	Size		MBS (lb)	WLL (lb)	Price / ea.	Part Number
	Length (ft)					
3	20		16 200	5400	86.51	126-3"X20' RWH
3	30		16 200	5400	95.70	126-3"X30'RWH

BUCKLE - RATCHET

- Material: 304 Stainless Steel
- Finish: Stainless Steel



For Webbing (in)	MBS (lb)	Price / ea.	Part Number
1	3300	24.80	6-1"SSRB

BUCKLE - RATCHET

- Finish: Zinc plated

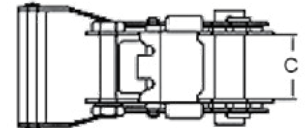
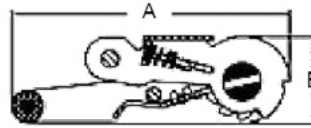

190-1-1/16"RB



190-1-1/2"RB



190-2"RB

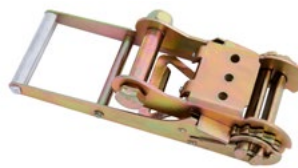

190-3"RB

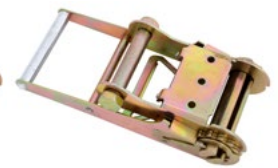

190-4"RB

Pictures are for illustration only, actual product may differ.

For Webbing (in)	MBS (lb)	Dimensions (mm)			Price / ea.	Part Number
		A	B	C		
1	3300	130	42	36	5.50	190-1-1/16"RB
1	6600	155	49	40	11.60	190-1-1/2"RB
2	12 000	230	57	52	11.90	190-2"RB
3	22 000	320	80	78	42.50	190-3"RB
4	22 000	320	80	102	54.65	190-4"RB

WEBBING - TIE DOWN MATERIAL, POLYESTER

Size (in)	MBS (lb)	Carton Packaging Qty (ft)	Price / Reel	Part Number
1	3300	328.08	41.05	190-1"TDW3300
1	6600	328.08	80.60	190-1"TDW6600
2	12 000	328.08	160.00	190-2"TDW12000
3	18 000	328.08	245.00	190-3"TDW18000
4	24 000	328.08	350.00	190-4"TDW24000

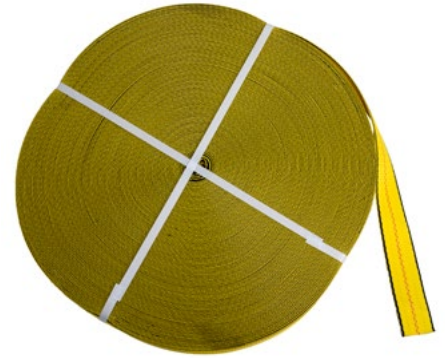

HOOK - WIRE, DOUBLE J

Size (in)	MBS (lb)	Dimensions (mm)			Price / ea.	Part Number
		A	B	C		
1 1/16	3300	27	7	56	0.95	190-1-1/16"WH
1 1/2	6600	36	9.3	60	2.20	190-1-1/2"WH
2	12 000	52	11.4	86	2.96	190-2"WH
3	22 000	76	16	130	9.78	190-3"WH
4	22 000	102	16	130	12.43	190-4"WH

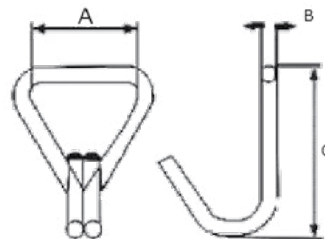



OCEAN G80 & G100 STEEL LIFTING COMPONENTS

G80 Master Links	25
G80 Connecting Links & Hooks	26 - 30
G80 Trigger, Load Pin, and Pin & Sleeve Kits	31
G80 Insulated Swivels & Coupling Components	32 - 34
G100 Master Links	35
G100 Connecting Links & Hooks	36 - 41
G100 Trigger, Load Pin, and Pin & Sleeve Kits	41 - 42
G80 Weld-On Bucket Hooks & Lifting Points	43 - 45
Lifting Eye Key Points	46 - 47
Swivel Hoist Rings	48 - 51

OCEAN®

RIGGING HARDWARE & PRODUCTS

Ocean® Brand grade 80 and 100 rigging products are manufactured in accordance with Quality Management System approved to ISO 9001 and 14001. All Ocean® Brand products are manufactured and Inspected in accordance with EN 1677 and Exceeds requirements of related ASME B30 Standards. To Ensure the quality of Ocean® Brand Products they are 100% Magnetic Flux tested, batch samples are fatigue tested for 20,000 cycles @ 1.5 times the working load limit, hardness is tested and destruction tests to ensure proper breaking loads. All testing is traceable back with a batch code embossed on the product.

LINK - MASTER LINK, GRADE 80, OCEAN® BRAND

- Material: Alloy Steel, Grade 80
- Standard: EN 1677-4 / ASTM A952/952M
- Finish: Powder Coated, Yellow
- Design Factor: 5:1
- Identification: Trademark, Size/WLL,
- Batch Code, Grade

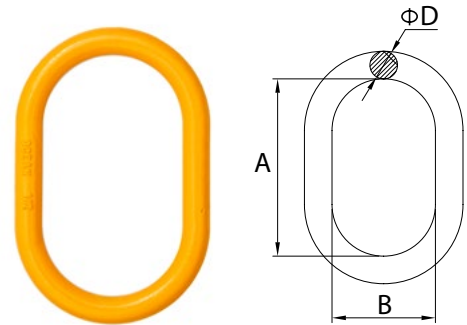

Trade Size (in)	WLL (lb)	Chain Size (in)		I.L. (in)	I.W. (in)	Dia. (in)	Wt. / ea. (lb)	Qty. / Box	Price / ea.	Part Number
		1-Leg	2-Leg							
1/2"	7 400	5/16"	7/32"	4.72	2.76	0.55	1.1	30	35.53	3-1/2"ML
5/8"	9 000	3/8"	5/16"	5.51	3.15	0.67	1.6	20	53.80	3-5/8"ML
3/4"	12 300	1/2"		5.91	3.54	0.85	2.4	15	73.13	3-3/4"ML
7/8"	15 200	1/2"	3/8"	6.30	3.74	0.87	3.5	13	92.54	3-7/8"ML
1"	26 000	5/8"		7.48	4.33	0.98	5.1	10	114.35	3-1"ML
1-1/8"	30 000	5/8"	1/2"	7.09	4.13	1.10	5.9	10	141.50	3-1-1/8"ML
1-1/4"	39 100	3/4"		7.87	4.72	1.18	7.6	4	175.61	3-1-1/4"ML
1-3/8"	42 000	7/8"	5/8"	9.45	5.51	1.34	11.7	4	322.52	3-1-3/8"ML
1-1/2"	61 100	1"		9.84	5.91	1.50	15.8	3	430.02	3-1-1/2"ML

LINK - CONNECTING LINK, GRADE 80, OCEAN® BRAND

- Material: Alloy Steel, Grade 80
- Standard: EN 1677-1/ ASTM A952/952M
- Finish: Powder Coated, Yellow
- Design Factor: 4:1
- Identification: Trademark, Size/WLL, Batch Code, Grade

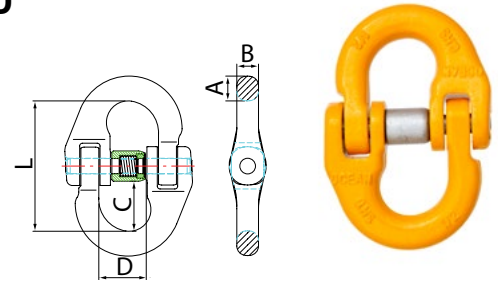

Grade 80 Chain (in)	WLL (lb)	Dimensions (in)					Wt. / ea. (lb)	Qty. / Box	Price / ea.	Part Number
		A	B	C	D	L				
9/32"	4 500	0.39	0.34	0.91	0.73	2.30	0.33	120	18.28	3-7-8CL
3/8"	7 100	0.52	0.45	1.04	1.00	2.72	0.71	70	21.41	3-10CL
1/2"	12 000	0.67	0.62	1.42	1.18	3.54	1.68	35	36.97	3-13CL
5/8"	18 100	0.75	0.75	1.50	1.43	3.94	2.73	20	59.49	3-16CL
3/4"	28 300	0.93	0.87	1.77	1.67	4.76	4.21	15	107.48	3-18-20CL
7/8"	34 200	1.11	0.94	2.38	1.94	6.06	7.82	6	177.76	3-22CL
1"	47 700	1.22	1.20	2.56	2.18	6.54	10.80	6	295.59	3-26CL
1-1/4"	72 300	1.54	1.42	3.15	2.75	8.07	20.28	2	542.90	3-32CL

HOOK - CLEVIS GRAB HOOK, GRADE 80, OCEAN® BRAND

- Material: Alloy Steel, Grade 80
- Standard: EN 1677-1/ ASTM A952/952M
- Finish: Powder Coated, Yellow
- Design Factor: 4:1
- Identification: Trademark, Size/WLL, Batch Code, Grade

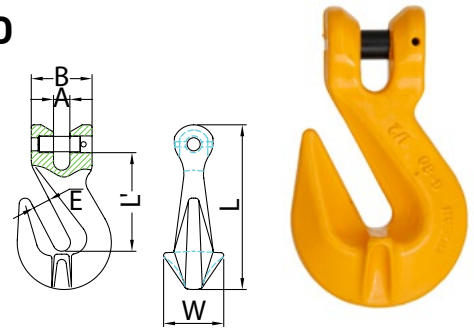

Grade 80 Chain (in)	WLL (lb)	Dimensions (in)							Wt. / ea. (lb)	Qty. / Box	Price / ea.	Part Number
		E	A	B	W	L	L*	M				
9/32"	4 500	0.41	0.37	1.54	1.36	3.50	2.09	2.09	0.71	70	16.67	3-7-8CGH
3/8"	7 100	0.51	0.49	1.83	1.81	5.04	2.95	2.80	1.61	30	32.05	3-10CGH
1/2"	12 000	0.65	0.59	2.09	2.26	6.44	3.62	3.78	3.53	12	69.20	3-13CGH
5/8"	18 100	0.75	0.73	2.74	2.91	7.22	3.90	4.45	6.17	8	96.99	3-16CGH
3/4"	28 300	0.94	0.91	3.19	2.91	8.62	4.84	5.63	11.02	4	211.29	3-18-20CGH
7/8"	34 200	1.06	1.06	3.58	3.54	10.00	5.51	6.30	13.89	3	297.99	3-22CGH
1"	47 700	1.18	1.18	4.61	4.02	12.17	7.36	7.13	31.96	1	945.61	3-26CGH
1-1/4"	72 300	1.61	1.38	5.91	5.12	14.88	8.39	8.66	52.90	1	2592.14	3-32CGH

HOOK - CLEVIS SLING HOOK, GRADE 80, OCEAN® BRAND

- Material: Alloy Steel, Grade 80
- Standard: EN 1677-5/ ASTM A952/952M
- Finish: Powder Coated, Yellow
- Design Factor: 4:1
- Identification: Trademark, Size/WLL, Batch Code, Grade

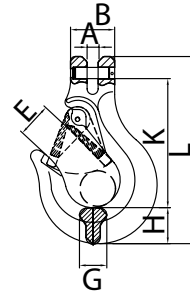

Grade 80 Chain (in)	WLL (lb)	Spare Latch Kit		Dimensions (in)								Wt. / ea. (lb)	Qty. / Box	Price / ea.	Part Number
		Price / ea.	Part #	A	B	E	G	H	K	L					
9/32"	4 500	11.25	3-7-8LK	0.37	1.77	1.02	0.75	0.91	3.84	5.43	1.3	30	30.81	3-7-8CSH	
3/8"	7 100	15.38	3-10LK	0.47	1.71	1.30	0.91	1.14	4.72	6.87	2.6	15	55.20	3-10CSH	
1/2"	12 000	23.94	3-13LK	0.59	2.24	1.57	1.10	1.50	5.79	8.39	5.1	9	75.77	3-13CSH	
5/8"	18 100	32.21	3-16LK	0.73	2.64	1.73	1.54	1.65	6.65	9.65	8.4	6	160.58	3-16CSH	
3/4"	28 300	39.25	3-18-20LK	0.98	3.94	2.13	1.85	2.01	7.48	12.76	14.8	3	342.56	3-18-20CSH	
7/8"	34 200	49.89	3-22LK	0.98	3.58	2.60	1.97	2.44	8.39	12.60	20.21	2	413.61	3-22CSH	
1"	47 700	67.44	3-26LK	1.18	4.61	3.35	2.36	2.95	9.91	15.31	32.99	2	580.93	3-26CSH	
1-1/4"	72 300	124.71	3-32LK	1.38	5.91	4.06	2.60	3.46	12.48	18.90	59.51	1	1594.43	3-32CSH	



HOOK - SELF LOCKING SWIVEL HOOK, GRADE 80, OCEAN® BRAND

- Material: Alloy Steel, Grade 80
- Standard: EN 1677-3/ ASTM A952/952M
- Finish: Powder Coated, Yellow
- Design Factor: 4:1
- Identification: Trademark, Size/WLL, Batch Code, Grade

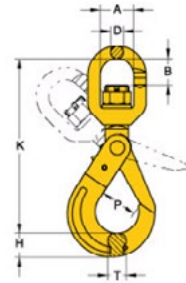

Grade 80 Chain (in)	WLL (lb)	Dimensions (in)							Wt. / ea. (lb)	Qty. / Box	Brass Bushing	
		A	B	D	H	K	P	T			Price / ea.	Part Number
1/4-5/16	4 500	1.42	1.14	0.51	0.94	7.32	1.34	0.79	2.6	15	113.95	3-7-8SSLH
3/8	7 100	1.8	1.49	0.62	1.19	8.9	1.77	1.02	4.4	8	170.18	3-10SSLH
1/2	12 000	1.81	1.86	0.83	1.57	11	2.01	1.26	9	4	288.89	3-13SSLH
5/8	18 100	2.36	2.16	0.91	1.93	13	2.44	1.3	15.9	3	444.42	3-16SSLH
3/4	28 300	2.91	3.23	1.02	2.36	15.28	2.76	2.09	24.9	2	1026.13	3-18-20SSLH
7/8	34 200	3.82	3.94	1.3	2.48	17.99	3.14	2.24	39.5	1	1837.54	3-22SSLH

HOOK - SELF LOCKING EYE HOOK, GRADE 80, OCEAN® BRAND

- Material: Alloy Steel, Grade 80
- Standard: EN 1677-3/ ASTM A952/952M
- Finish: Powder Coated, Yellow
- Design Factor: 4:1
- Identification: Trademark, Size/WLL, Batch Code, Grade



Grade 80 Chain (in)	WLL (lb)	Dimensions (in)						Wt. / ea. (lb)	Qty. / Box	Price / ea.	Part Number
		A	D	H	K	P	T				
1/4 - 5/16	4 500	0.98	0.43	1.02	5.35	1.34	0.79	1.8	25	56.32	3-7-8SLEH
3/8	7 100	1.26	0.51	1.24	6.57	1.73	1.02	3.3	12	87.88	3-10SLEH
1/2	12 000	1.57	0.63	1.65	8.15	2.01	1.18	6.6	6	165.70	3-13SLEH
5/8	18 100	1.97	0.83	2.2	9.92	2.36	1.3	12.5	3	349.52	3-16SLEH
3/4	28 300	2.36	0.91	2.56	11.42	2.76	2.09	22.2	2	603.67	3-18-20SLEH
7/8	34 200	2.76	0.94	2.8	12.56	3.15	2.24	24	2	934.55	3-22SLEH

HOOK - SELF LOCKING CLEVIS HOOK, GRADE 80, OCEAN® BRAND

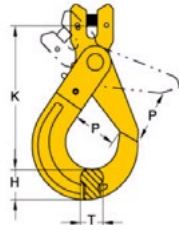

- Material: Alloy Steel, Grade 80
- Standard: EN 1677-3/ ASTM A952/952M
- Finish: Powder Coated, Yellow
- Design Factor: 4:1
- Identification: Trademark, Size/WLL, Batch Code, Grade

Grade 80 Chain (in)	WLL (lb)	Dimensions (in)					Wt. / ea. (lb)	Qty. / Box	Price / ea.	Part Number
		A	P	T	H	K				
1/4 - 5/16	4 500	0.37	1.34	0.79	0.94	4.65	2.07	20	57.14	3-7-8SLCH
3/8	7 100	0.49	1.73	1.02	1.18	5.59	3.1	12	92.44	3-10SLCH
1/2	12 000	0.59	2.05	1.26	1.56	7.01	6.2	6	186.28	3-13SLCH
5/8	18 100	0.73	2.36	1.30	1.97	8.31	12.3	3	376.98	3-16SLCH
3/4	28 300	0.98	2.76	2.09	2.64	9.84	19.8	2	585.99	3-18-20SLCH

HOOK - FOUNDRY EYE HOOK, GRADE 80, OCEAN® BRAND

- Material: Alloy Steel, Grade 80
- Standard: EN 1677-1/ ASTM A952/952M
- Finish: Powder Coated, Yellow
- Design Factor: 4:1
- Identification: Trademark, Size/WLL, Batch Code, Grade

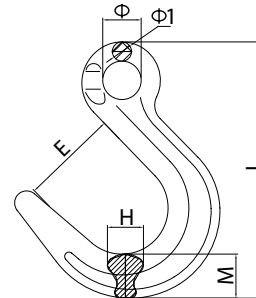

Grade 80 Chain (in)	WLL (lb)	Dimensions (in)						Wt. / ea. (lb)	Qty. / Box	Price / ea.	Part Number
		E	H	M	Φ	Φ1	L				
3/8"	7 100	2.87	0.98	1.18	1.24	0.59	7.76	3.00	16	46.42	3-3/8FEH
1/2"	12 000	3.54	1.30	1.54	1.73	0.75	9.37	5.66	10	103.87	3-1/2FEH
5/8"	18 100	4.13	1.46	1.65	1.93	0.87	10.87	8.73	6	148.55	3-5/8FEH
3/4"	28 300	4.49	1.81	2.24	2.36	1.02	12.83	16.13	4	288.23	3-3/4FEH

HOOK - CONTAINER HOOK, GRADE 80, OCEAN® BRAND

- Material: Alloy Steel, Grade 80
- Standard: EN 1677-1/ ASTM A952/952M
- Finish: Powder Coated, Yellow
- Design Factor: 4:1
- Identification: Trademark, Size/WLL, Batch Code, Grade
- Rated in Metric Ton(s)
- not compatible with Yoke

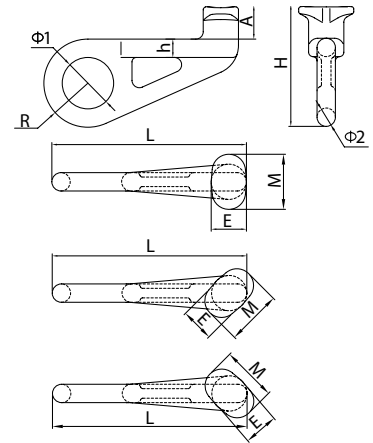

WLL (t)	Type	Dimensions (in)									Wt. / ea. (lb)	Qty. / Box	Price / ea.	Part Number
		A	M	H	E	R	Φ1	Φ2	L					
12.5	Left 45	1.81	2.95	6.54	0.98	1.89	2.36	2.76	0.98	10.43	9.09	6	211.85	3-8-06745LT
12.5	Right 45	1.81	2.95	6.54	0.98	1.89	2.36	2.76	0.98	10.43	9.09	6	211.85	3-8-06745RH

HOOK - SLIDING CHOKER HOOKS, GRADE 80, OCEAN® BRAND

- Material: Alloy Steel, Grade 80
- Standard: EN 1677-1/ ASTM A952/952M
- Finish: Powder Coated, Yellow
- Design Factor: 5:1
- Identification: Trademark, Size/WLL, Batch Code, Grade
- Based on degree of angle, loads will change.

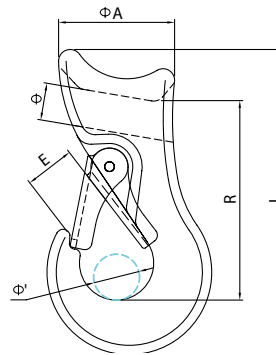

WLL (lb)	Wire Rope Dia. (in)	Latch Kit		Dimensions (in)						Wt. / ea. (lb)	Qty. / Box	Price / ea.	Part Number
		Price / ea.	Part Number	Φ	Φ'	A	E	L	R				
3 800	3/8-1/2	13.45	3-9-13LK	0.67	0.71	1.97	0.71	5.20	3.43	1.50	30	56.51	3-9-13SCH
5 800	9/16-5/8	14.98	3-14-16LK	0.87	0.75	2.50	0.75	5.94	3.98	2.67	20	88.71	3-14-16SCH

HOOK - KIT, SELF-LOCKING RECESSED TRIGGER KIT, GRADE 80/100, OCEAN® BRAND

For Grade 80/100 Self-Locking Recessed Hooks



Grade 80/100 Chain (in)	Price / ea.	Part Number
1/4-5/16	19.96	3-7-8TK
3/8	27.53	3-10TK
1/2	53.80	3-13TK
5/8	79.44	3-16TK
3/4	115.68	3-18-20TK
7/8	166.26	3-22TK
1	275.06	3-26TK

HOOK - KIT, CLEVIS, LOAD PIN KIT, GRADE 80, OCEAN® BRAND

Grade 80 Material only



Grade 80 Chain (in)	WLL (lb)	Price / ea.	Part Number
9/32	4 500	14.53	3-7-8LPK
3/8	7 100	19.88	3-10LPK
1/2	12 000	30.62	3-13LPK
5/8	18 100	53.35	3-16LPK
3/4	28 300	66.62	3-18-20LPK
7/8	34 200	79.24	3-22LPK
1	47 700	93.14	3-26LPK
1 1/4	72 300	108.49	3-32LPK

LINK - KIT, CONNECTING, PIN & SLEEVE KIT, GRADE 80, OCEAN® BRAND



Grade 80 Chain (in)	WLL (lb)	Price / ea.	Part Number
1/4 - 5/16	4 500	9.73	3-7-8CLP
3/8	7 100	14.11	3-10CLP
1/2	12 000	18.50	3-13CLP
5/8	18 100	27.78	3-16CLP
3/4	28 300	46.35	3-18-20CLP
7/8	34 200	63.11	3-22CLP
1	47 700	93.20	3-26CLP
1 1/4	72 300	152.47	3-32CLP

LINK - COUPLING, HALF LINK & PIN, GRADE 80, OCEAN® BRAND



- Material: Alloy Steel, Grade 80
- Standard: EN 1677-1
- Finish: Powder Coated, Yellow
- Design Factor: 4:1
- Identification: Trademark, Size/WLL, Batch Code, Grade
- Pin & Sleeve included.

Grade 80 Chain (in)	WLL (lb)	Dimensions (in)				Wt./ea. (lb)	Qty. / Box	Price / ea.	Part Number
		A	D	K	L				
9/32	4500	0.81	0.35	0.94	1.10	0.2	150	12.47	3-9/32CLH
3/8	7 100	1.10	0.50	1.12	1.3	0.4	100	14.81	3-3/8CLH
1/2	12 000	1.18	0.62	1.26	1.77	0.9	50	24.92	3-1/2CLH
5/8	18 100	1.42	0.75	1.63	1.97	1.3	25	37.19	3-5/8CLH
3/4	28 300	1.73	0.87	1.75	2.36	2.4	15	74.45	3-3/4CLH

LINK - COUPLING, ROUND SLING, GRADE 80, OCEAN® BRAND

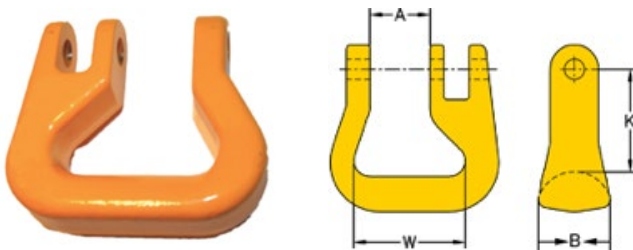

- Material: Alloy Steel, Grade 80
- Standard: EN 1677-1
- Finish: Powder Coated, Yellow
- Design Factor: 4:1
- Identification: Trademark, Size/WLL, Batch Code, Grade

Grade 80 Chain (in)	WLL (lb)	Dimensions (in)				Wt./ea. (lb)	Qty. / Box	Price / ea.	Part Number
		A	B	K	W				
9/32	4500	0.81	0.94	1.30	1.57	0.4	80	21.41	3-9/32CRS
3/8	7100	1.10	1.14	1.65	1.85	0.9	50	28.29	3-3/8CRS
1/2	12 000	1.18	1.38	2.01	2.09	1.5	30	44.18	3-1/2CRS
5/8	18 100	1.42	1.73	2.48	2.64	2.9	15	80.83	3-5/8CRS
3/4	28 300	1.73	2.05	2.87	3.17	4.6	10	110.10	3-3/4CRS

LINK - COUPLING & PIN, GRADE 80, OCEAN® BRAND

- Material: Alloy Steel, Grade 80
- Standard: EN 1677-1 / ASTM A952/952M
- Finish: Powder Coated, Yellow
- Design Factor: 4:1
- Identification: Trademark, Size/WLL, Batch Code, Grade

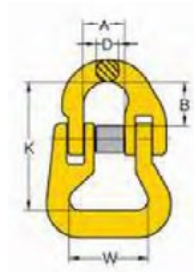

Grade 80 Chain (in)	WLL (lb)	Dimensions (in)					Wt./ea. (lb)	Qty. / Box	Price / ea.	Part Number
		A	B	D	K	W				
1/2	12 000	1.19	1.38	0.62	3.74	2.09	2.4	25	77.51	3-016-13
5/8	18 100	1.42	1.51	0.75	4.53	2.64	4.4	15	132.98	3-016-16
3/4	28 300	1.65	1.81	0.87	6.20	3.15	7.1	6	199.39	3-016-20

SWIVEL - COUPLING, INSULATED BLANK SWIVEL, GRADE 80, OCEAN® BRAND

- Material: Alloy Steel, Grade 80
- Standard: EN 1677-1 / ASTM A952/952M
- Finish: Powder Coated, Yellow
- Design Factor: 4:1
- Identification: Trademark, Size/WLL, Batch Code, Grade
- Contain load pins

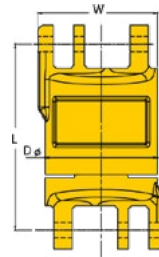

WLL (lb)	Grade 80 Chain (in)	Dimensions (in)			Wt./ea. (lb)	Qty. / Box	Price / ea.	Part Number
		L	D	W				
4500	9/32	2.99	1.89	1.97	1.9	30	420.24	3-9/32BSI
7100	3/8	3.66	2.28	2.44	2.6	15	655.96	3-3/8BSI
12 000	1/2	4.80	2.91	3.09	5.5	6	892.72	3-1/2BSI
18 100	5/8	5.60	3.54	3.74	9.7	4	1140.10	3-5/8BSI
28 300	3/4	6.25	4.13	4.33	15.3	3	1483.15	3-3/4BSI

LINK - COUPLING, MASTER LINK, GRADE 80, OCEAN® BRAND

- Material: Alloy Steel, Grade 80
- Standard: EN 1677-1 / ASTM A952/952M
- Finish: Powder Coated, Yellow
- Design Factor: 4:1
- Identification: Trademark, Size/WLL, Batch Code, Grade
- Contain load pins

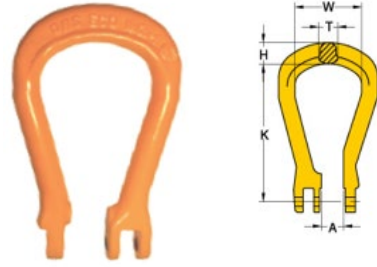

Grade 80 Chain (in)	WLL (lb)	Dimensions (in)					Wt./ea. (lb)	Qty. / Box	Price / ea.	Part Number
		A	H	K	T	W				
9/32	4500	0.81	0.59	3.94	0.59	1.97	0.7	50	37.13	3-9/32MLC
3/8	7100	1.10	0.91	5.00	0.75	2.56	1.5	25	54.18	3-3/8MLC
1/2	12 000	1.18	0.94	5.71	0.91	2.83	2.2	18	71.99	3-1/2MLC
5/8	18 100	1.43	1.02	6.85	0.98	3.15	3.5	10	95.36	3-5/8MLC
3/4	28 300	1.73	1.42	8.11	1.22	4.09	6.6	5	193.07	3-3/4MLC

HOOK - COUPLING, SELF-LOCKING, GRADE 80, OCEAN® BRAND

- Material: Alloy Steel, Grade 80
- Standard: EN 1677-1/ ASTM A952/952M
- Finish: Powder Coated, Yellow
- Design Factor: 4:1
- Identification: Trademark, Size/WLL, Batch Code, Grade

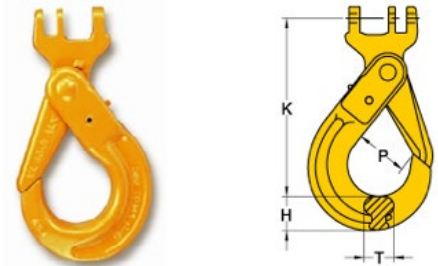

Grade 80 Chain (in)	WLL (lb)	Dimensions (in)				Wt./ea. (lb)	Qty. / Box	Price / ea.	Part Number
		H	K	P	T				
9/32	4500	0.94	5.35	1.34	0.79	1.8	25	59.49	3-9/32CSLH
3/8	7 100	1.19	6.06	1.77	1.02	3.1	14	87.14	3-3/8CSLH
1/2	12 000	1.57	7.95	2.13	1.19	6.4	6	173.15	3-1/2CSLH
5/8	18 100	1.93	9.53	2.44	1.30	11.9	3	322.36	3-5/8CSLH
3/4	28 300	2.56	10.12	2.76	2.09	22.3	2	567.73	3-3/4CSLH

LINK - KIT, CONNECTING, PIN & SLEEVE KIT, GRADE 80, FOR OCEAN® BRAND COUPLING SERIES

For Coupling assemblies, Grade 80 Material only

Size (in)	WLL (lb)	Price / ea.	Part Number
1/4 - 5/16	4500	10.55	3-9/32CLP
3/8	7100	14.53	3-3/8CLP
1/2	12 000	19.08	3-1/2CLP
5/8	18 100	28.61	3-5/8CLP
3/4	28 300	47.67	3-3/4CLP



OCEAN®

RIGGING HARDWARE & PRODUCTS

OCEAN G80 and OCEAN G100
Ocean® Brand grade 80 and 100 rigging products are manufactured in accordance with Quality Management System approved to ISO 9001 and 14001. All Ocean® Brand products are manufactured and Inspected in accordance with EN 1677 and Exceeds requirements of related ASME B30 Standards. To Ensure the quality of Ocean® Brand Products they are 100% Magnetic Flux tested, batch samples are fatigue tested for 20,000 cycles @ 1.5 times the working load limit, hardness is tested and destruction tests to ensure proper breaking loads. All testing is traceable back with a batch code embossed on the product.

LINK - MASTER LINK, GRADE 100, OCEAN® BRAND

- Material: Alloy Steel, Grade 100
- Standard: EN 1677-4 / ASTM A952/952M
- Finish: Powder Coated, Blue
- Design Factor: 5:1
- Identification: Trademark, Size/WLL, Batch Code, Grade

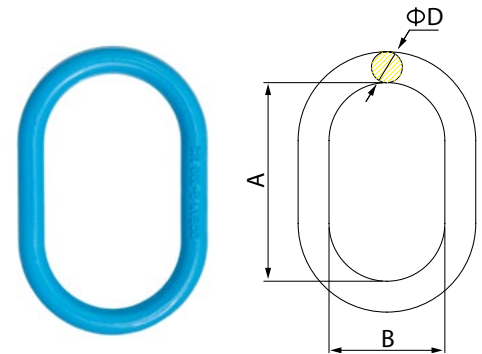

Trade Size (in)	WLL (lb)	Chain Size (in)		I.L. (in)	I.W. (in)	Dia. (in)	Wt. / ea. (lb)	Qty. / Box	Price / ea.	Part Number
		1-Leg	2-Leg							
1/2"	7 400	5/16"	7/32"	4.72	2.76	0.55	1.1	30	39.32	3-X-1/2"ML
5/8"	9 000	3/8"	5/16"	5.51	3.15	0.67	1.6	20	56.68	3-X-5/8"ML
3/4"	12 300	1/2"		5.91	3.54	0.85	2.4	15	82.40	3-X-3/4"ML
7/8"	15 200	1/2"	3/8"	6.30	3.74	0.87	3.5	13	97.09	3-X-7/8"ML
1"	26 000	5/8"		7.48	4.33	0.98	5.1	10	132.08	3-X-1"ML
1-1/8"	30 000	5/8"	1/2"	7.09	4.13	1.10	5.9	10	153.46	3-X-1-1/8"ML
1-1/4"	39 100	3/4"		7.87	4.72	1.18	7.6	4	218.48	3-X-1-1/4"ML
1-3/8"	42 000	7/8"	5/8"	9.45	5.51	1.34	11.7	4	376.36	3-X-1-3/8"ML
1-1/2"	61 100	1"		9.84	5.91	1.50	15.8	3	453.87	3-X-1-1/2"ML

LINK - CONNECTING LINK, GRADE 100, OCEAN® BRAND

- Material: Alloy Steel, Grade 100
- Standard: EN 1677-1 / ASTM A952/952M
- Finish: Powder Coated, Blue
- Design Factor: 4:1
- Identification: Trademark, Size/WLL, Batch Code, Grade

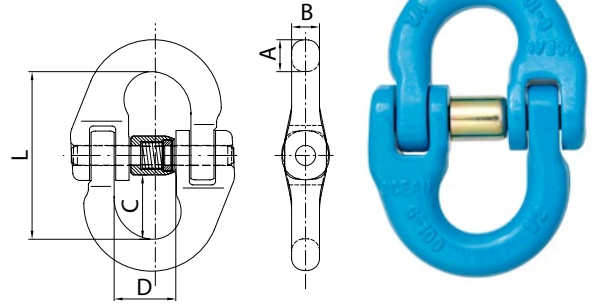

Grade 100 Chain (in)	WLL (lb)	Dimensions (in)					Wt. / ea. (lb)	Qty. / Box	Price / ea.	Part Number
		A	B	C	D	L				
9/32"	5 700	0.39	0.34	0.91	0.73	2.30	0.33	120	21.15	3-X-7-8CL
3/8"	8 800	0.52	0.45	1.04	1.00	2.72	0.71	70	22.42	3-X-10CL
1/2"	15 000	0.67	0.62	1.42	1.18	3.54	1.68	35	47.02	3-X-13CL
5/8"	22 600	0.75	0.75	1.50	1.43	3.94	2.73	20	59.49	3-X-16CL
3/4"	35 300	0.93	0.87	1.77	1.67	4.76	4.21	15	119.98	3-X-18-20CL
7/8"	42 700	1.11	0.94	2.38	1.94	6.06	7.82	6	187.48	3-X-22CL
1"	59 700	1.22	1.20	2.56	2.18	6.54	10.80	6	304.43	3-X-26CL
1-1/4"	90 400	1.54	1.42	3.15	2.75	8.07	20.28	2	576.70	3-X-32CL

HOOK - CLEVIS GRAB HOOK, GRADE 100, OCEAN® BRAND

- Material: Alloy Steel, Grade 100
- Standard: EN 1677-1 / ASTM A952/952M
- Finish: Powder Coated, Blue
- Design Factor: 4:1
- Identification: Trademark, Size/WLL, Batch Code, Grade

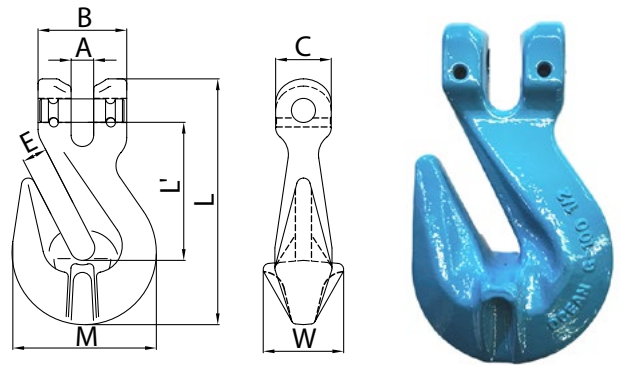

Grade 100 Chain (in)	WLL (lb)	Dimensions (in)								Wt. / ea. (lb)	Qty. / Box	Price / ea.	Part Number
		A	B	C	E	M	W	L*	L				
9/32"	5 700	0.37	1.42	0.94	0.43	2.13	1.32	2.09	3.66	0.75	60	24.57	3-X-7-8CGH
3/8"	8 800	0.49	1.81	1.16	0.53	2.83	1.65	2.87	5.00	1.81	30	37.29	3-X-10CGH
1/2"	15 000	0.59	2.32	1.46	0.59	3.78	2.11	3.62	6.46	3.86	12	75.46	3-X-13CGH
5/8"	22 600	0.73	2.76	1.81	0.75	4.53	2.91	4.06	7.40	6.35	7	131.88	3-X-16CGH
3/4"	35 300	0.94	3.35	2.05	0.98	5.71	3.43	4.84	8.78	10.67	4	239.61	3-X-18-20CGH
7/8"	42 700	1.06	3.94	2.40	1.06	6.26	3.54	5.55	10.24	18.29	2	414.22	3-X-22CGH
1"	59 700	1.18	4.33	2.76	1.34	7.48	4.33	7.36	12.60	30.24	1	1034.98	3-X-26CGH

HOOK - CLEVIS GRAB HOOK WITH PIN, GRADE 100, OCEAN® BRAND

- Material: Alloy Steel, Grade 100
- Standard: EN 1677-1 / ASTM A952/952M
- Finish: Powder Coated, Blue
- Design Factor: 4:1
- Identification: Trademark, Size/WLL, Batch Code, Grade

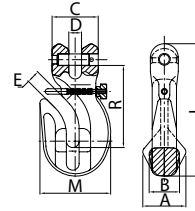

Grade 100 Chain (in)	WLL (lb)	Dimensions (in)								Wt. / ea. (lb)	Qty. / Box	Price / ea.	Part Number
		A	B	C	R	D	E	L	M				
5/16"	5 700	1.40	0.98	1.50	2.60	0.39	0.41	4.29	2.20	1.37	50	70.41	3-X-5/16"CGHSP
3/8"	8 800	1.73	1.26	1.81	3.23	0.47	0.51	5.28	2.72	2.56	25	114.16	3-X-3/8"CGHSP
1/2"	15 000	2.24	1.57	2.34	4.21	0.59	0.61	6.91	3.66	5.73	12	186.45	3-X-1/2"CGHSP

HOOK - CLEVIS SLING HOOK, GRADE 100, OCEAN® BRAND

- Material: Alloy Steel, Grade 100
- Standard: EN 1677-5 / ASTM A952/952M
- Finish: Powder Coated, Blue
- Design Factor: 4:1
- Identification: Trademark, Size/WLL, Batch Code, Grade

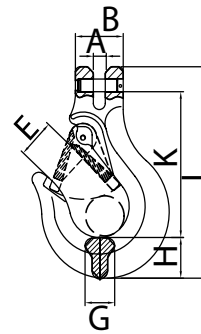

Grade 100 Chain (in)	WLL (lb)	Spare Latch Kit		Dimensions (in)							Wt./ ea. (lb)	Qty./ Box	Price/ ea.	Part Number
		Price/ ea.	Part #	A	B	E	G	H	K	L				
9/32"	5 700	10.70	3-7-8LK	0.37	1.77	1.02	0.75	0.91	3.84	5.43	1.3	30	37.58	3-X-7-8CSH
3/8"	8 800	14.65	3-10LK	0.47	1.71	1.30	0.91	1.14	4.72	6.87	2.6	15	70.09	3-X-10CSH
1/2"	15 000	22.79	3-13LK	0.59	2.24	1.57	1.10	1.50	5.79	8.39	5.1	9	101.34	3-X-13CSH
5/8"	22 600	30.67	3-16LK	0.73	2.64	1.73	1.54	1.65	6.65	9.65	8.4	6	218.32	3-X-16CSH
3/4"	35 300	37.39	3-18-20LK	0.98	3.94	2.13	1.85	2.01	7.48	12.76	14.8	3	387.97	3-X-18-20CSH
7/8"	42 700	47.51	3-X-22LK	1.06	3.94	2.56	1.97	2.44	8.43	12.83	26.7	2	778.90	3-X-22CSH
1"	59 700	64.23	3-X-26LK	1.20	4.65	2.83	2.36	2.87	9.72	15.08	35.5	2	1263.68	3-X-26CSH

HOOK - SWIVEL SELF LOCKING HOOK BRASS BUSHING, GRADE 100, OCEAN® BRAND

- Material: Alloy Steel, Grade 100
- Standard: EN 1677-3 / ASTM A952/952M
- Finish: Powder Coated, Blue
- Design Factor: 4:1
- Identification: Trademark, Size/WLL, Batch Code, Grade

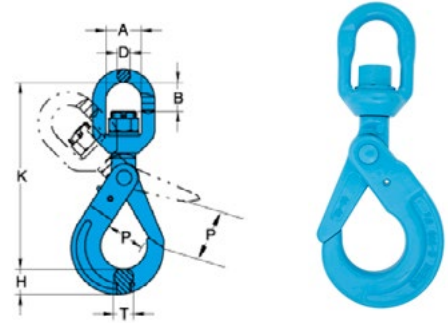

Grade 100 Chain (in)	WLL (lb)	Dimensions (in)							Wt. / ea. (lb)	Qty. / Box	Brass Bushing	
		A	B	D	H	K	P	T			Price / ea.	Part Number
1/4-5/16	5 700	1.42	1.14	0.51	0.94	7.32	1.34	0.79	2.6	15	133.28	3-X-7-8SSLH
3/8	8 800	1.8	1.49	0.62	1.19	8.9	1.77	1.02	4.4	8	195.29	3-X-10SSLH
1/2	15 000	1.81	1.86	0.83	1.57	11	2.01	1.26	9	4	340.98	3-X-13SSLH
5/8	22 600	2.36	2.16	0.91	1.93	13	2.44	1.3	15.9	3	505.76	3-X-16SSLH
3/4	35 300	2.91	3.23	1.02	2.36	15.28	3.54	2.09	24.9	2	1054.53	3-X-18-20SSLH
7/8	42 700	3.82	3.94	1.3	2.48	17.99	3.14	2.15	39.5	1	2175.42	3-X-22SSLH
1	59 700	4.84	4.53	2.09	2.72	21.06	3.90	2.20	69.3	1	3934.20	3-X-26SSLH

HOOK - SWIVEL SELF LOCKING HOOK BALL BEARING, GRADE 100, OCEAN® BRAND

- Material: Alloy Steel, Grade 100
- Standard: EN 1677-3 / ASTM A952/952M
- Finish: Powder Coated, Blue
- Design Factor: 4:1
- Identification: Trademark, Size/WLL, Batch Code, Grade



Grade 100 Chain (in)	WLL (lb)	Dimensions (in)							Wt. / ea. (lb)	Qty. / Box	Ball Bearing	
		A	B	D	H	K	P	T			Price / ea.	Part Number
3/8	8 800	1.8	1.49	0.62	1.19	8.9	1.77	1.02	4.4	8	214.13	3-X-10SWBB
1/2	15 000	1.81	1.86	0.83	1.57	11	2.01	1.26	9	4	413.61	3-X-13SWBB
5/8	22 600	2.36	2.16	0.91	1.93	13	2.44	1.3	15.9	4	704.13	3-X-16SWBB
3/4	35 300	2.91	3.23	1.02	2.36	15.28	3.54	2.09	24.9	2	1103.47	3-X-18-20SWBB
7/8	42 700	3.82	3.94	1.3	2.48	17.99	3.14	2.15	39.5	1	2191.15	3-X-22SWBB
1	59 700	4.84	4.53	2.09	2.72	21.06	3.90	2.20	69.3	1	4210.31	3-X-26SWBB

HOOK - SELF LOCKING EYE HOOK, GRADE 100, OCEAN® BRAND

- Material: Alloy Steel, Grade 100
- Standard: EN 1677-3 / ASTM A952/952M
- Finish: Powder Coated, Blue
- Design Factor: 4:1
- Identification: Trademark, Size/WLL, Batch Code, Grade

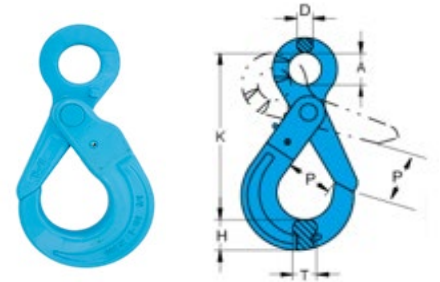

Grade 100 Chain (in)	WLL (lb)	Dimensions (in)						Wt. / ea. (lb)	Qty. / Box	Price / ea.	Part Number
		A	D	H	K	P	T				
1/4 - 5/16	5700	0.98	0.43	1.02	5.35	1.34	0.79	1.8	25	65.36	3-X-7-8SLEH
3/8	8800	1.26	0.51	1.24	6.57	1.73	1.02	3.3	12	103.19	3-X-10SLEH
1/2	15 000	1.57	0.63	1.65	8.15	2.01	1.18	6.6	6	190.70	3-X-13SLEH
5/8	22 600	1.97	0.83	2.2	9.92	2.36	1.42	12.5	3	364.39	3-X-16SLEH
3/4	35 300	2.36	0.91	2.56	11.42	2.76	2.09	22.2	2	667.16	3-X-18-20SLEH
7/8	42 700	2.76	0.94	2.8	12.56	3.15	1.93	24	2	935.04	3-X-22SLEH

HOOK - SELF LOCKING CLEVIS HOOK, GRADE 100, OCEAN® BRAND

- Material: Alloy Steel, Grade 100
- Standard: EN 1677-3 / ASTM A952/952M
- Finish: Powder Coated, Blue
- Design Factor: 4:1
- Identification: Trademark, Size/WLL, Batch Code, Grade

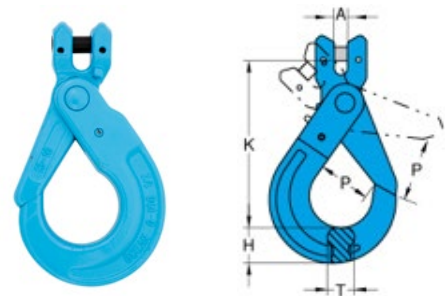

Grade 100 Chain (in)	WLL (lb)	Dimensions (in)					Wt. / ea. (lb)	Qty. / Box	Price / ea.	Part Number
		A	P	T	H	K				
1/4 - 5/16	5700	0.37	1.34	0.79	0.94	4.65	2.07	20	66.12	3-X-7-8SLCH
3/8	8800	0.49	1.73	1.02	1.18	5.59	3.1	12	100.73	3-X-10SLCH
1/2	15 000	0.59	2.05	1.26	1.56	7.01	6.2	6	201.76	3-X-13SLCH
5/8	22 600	0.73	2.36	1.30	1.97	8.31	12.3	3	388.03	3-X-16SLCH
3/4	35 300	0.98	2.76	2.09	2.64	9.84	19.8	2	691.09	3-X-18-20SLCH
7/8	42 700	0.98	3.15	2.24	2.56	12.60	24	2	990.19	3-X-22SLCH

HOOK - EYE SLING HOOKS, GRADE 100, OCEAN® BRAND

- Material: Alloy Steel, Grade 100
- Standard: EN 1677-5 / ASTM A952/952M
- Finish: Powder Coated, Blue
- Design Factor: 4:1
- Identification: Trademark, Size/WLL, Batch Code, Grade

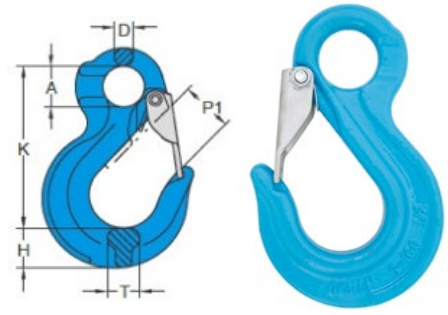

Grade 100 Chain (in)	WLL (lb)	Dimensions (in)						Wt. / ea. (lb)	Qty. / Box	Price / ea.	Part Number
		D	P1	A	T	K	H				
9/32	5 700	0.47	1.10	0.98	0.79	3.88	0.89	1.10	30	33.14	3-X-7-8ESH
3/8	8 800	0.57	1.42	1.26	0.91	4.76	1.20	2.20	15	49.70	3-X-10ESH
1/2	15 000	0.73	1.57	1.57	1.12	6.02	1.48	4.63	9	88.79	3-X-13ESH
5/8	22 600	0.87	1.77	1.97	1.46	7.28	1.81	6.80	5	173.01	3-X-16ESH

HOOK - FOUNDRY EYE HOOKS, GRADE 100, OCEAN® BRAND

- Material: Alloy Steel, Grade 100
- Standard: EN 1677-1 / ASTM A952/952M
- Finish: Powder Coated, Blue
- Design Factor: 4:1
- Identification: Trademark, Size/WLL, Batch Code, Grade

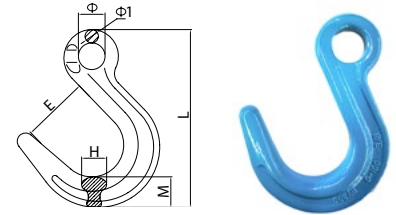

Grade 100 Chain (in)	WLL (lb)	Dimensions (in)						Wt. / ea. (lb)	Qty. / Box	Price / ea.	Part Number
		E	H	M	Φ	Φ1	L				
3/8"	8 800	2.87	0.98	1.18	1.24	0.59	7.83	3.00	18	73.09	3-X-3/8FEH
1/2"	15 000	3.54	1.30	1.54	1.73	0.75	9.37	5.66	8	140.75	3-X-1/2FEH
5/8"	22 600	4.13	1.46	1.65	1.93	0.87	10.98	8.73	6	222.25	3-X-5/8FEH
3/4"	35 300	4.49	1.81	2.24	2.36	1.02	12.99	16.09	4	403.85	3-X-3/4FEH
7/8"	42 700	4.84	2.36	2.76	2.52	1.22	14.50	25.13	2	688.89	3-X-7/8FEH

HOOK - FOUNDRY CLEVIS HOOKS, GRADE 100, OCEAN® BRAND

- Material: Alloy Steel, Grade 100
- Standard: EN 1677-1 / ASTM A952/952M
- Finish: Powder Coated, Blue
- Design Factor: 4:1
- Identification: Trademark, Size/WLL, Batch Code, Grade

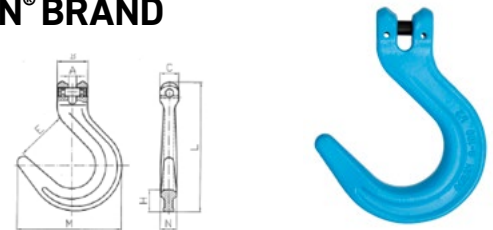

Grade 100 Chain (in)	WLL (lb)	Dimensions (in)								Wt. / ea. (lb)	Qty. / Box	Price / ea.	Part Number
		A	B	C	E	M	N	H	L				
3/8	8 800	0.49	1.89	1.16	2.83	6.02	0.98	1.22	7.56	3.13	15	78.58	3-X-3/8FCH
1/2	15 000	0.59	2.32	1.38	3.46	7.32	1.30	1.54	9.13	6.35	6	148.50	3-X-1/2FCH
5/8	22 600	0.73	2.76	1.81	4.06	8.58	1.57	1.97	11.18	11.24	4	242.25	3-X-5/8FCH

HOOK - WEB AND ROUND SLING HOOK, GRADE 100, OCEAN® BRAND

- Material: Alloy Steel, Grade 100
- Standard: EN 1677-1 / ASTM A952/952M
- Finish: Powder Coated, Blue
- Design Factor: 4:1
- Identification: Trademark, Size/WLL, Batch Code, Grade

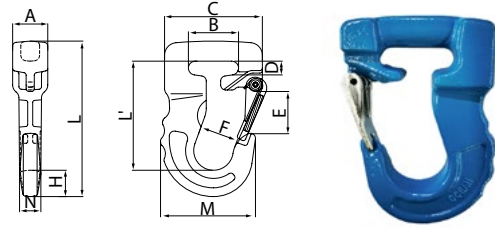

Size (t)	WLL (lb)	Dimensions (in)											Wt./ea. (lb)	Qty. / Box	Price / ea.	Part Number
		A	B	C	D	M	E	F	L	L*	H	N				
1	2200	1.10	1.57	3.07	0.43	2.98	1.26	1.22	4.88	3.43	0.83	0.67	1.61	30	58.82	3-X-032-01
2	4400	1.38	1.75	3.58	0.49	3.54	1.57	1.54	5.83	4.06	1.06	0.83	2.80	16	93.96	3-X-032-02
3	6600	1.77	2.13	4.45	0.61	4.33	1.57	1.85	6.89	4.53	1.30	1.02	5.07	10	169.17	3-X-032-03
4	8800	2.20	3.01	5.24	0.83	5.47	1.97	2.36	8.78	5.79	1.59	1.26	10.14	6	307.06	3-X-032-04
5	11000	2.20	3.01	5.24	0.83	5.47	1.97	2.36	8.78	5.79	1.59	1.26	10.14	6	307.06	3-X-032-05
6	13200	2.20	3.01	5.24	0.83	5.47	1.97	2.36	8.78	5.79	1.59	1.26	10.14	6	307.06	3-X-032-06

HOOK - KIT, SELF-LOCKING RECESSED TRIGGER KIT, GRADE 80/100, OCEAN® BRAND



For Grade 80/100 Self-Locking Recessed Hooks

Grade 80/100 Chain (in)	Price / ea.	Part Number
1/4-5/16	19.96	3-7-8TK
3/8	27.53	3-10TK
1/2	53.80	3-13TK
5/8	79.44	3-16TK
3/4	115.68	3-18-20TK
7/8	166.26	3-22TK
1	275.06	3-26TK

HOOK - KIT, CLEVIS, LOAD PIN KIT, GRADE 100, OCEAN® BRAND

Grade 100 Material only



Grade 100 Chain (in)	WLL (lb)	Price / ea.	Part Number
9/32	5 700	14.53	3-X-7-8LPK
3/8	8 800	19.90	3-X-10LPK
1/2	15 000	30.62	3-X-13LPK
5/8	22 600	53.35	3-X-16LPK
3/4	35 300	66.62	3-X-18-20LPK
7/8	42 700	79.25	3-X-22LPK
1	59 700	93.14	3-X-26LPK

LINK - KIT, CONNECTING, PIN & SLEEVE KIT, GRADE 100, OCEAN® BRAND

For Coupling assemblies, Grade 100 Material only



Grade 100 Chain (in)	WLL (lb)	Price / ea.	Part Number
1/4 - 5/16	5 700	9.73	3-X-7-8CLP
3/8	8 800	14.13	3-X-10CLP
1/2	15 000	18.50	3-X-13CLP
5/8	22 600	27.79	3-X-16CLP
3/4	35 300	46.36	3-X-18-20CLP
7/8	42 700	63.12	3-X-22CLP
1	59 700	93.20	3-X-26CLP
1 1/4	94 000	152.47	3-X-32CLP

HOOK - WELD ON BUCKET HOOK, GRADE 80, OCEAN® BRAND

- Material: Alloy Steel, Grade 80
- Standard: EN 1677-1
- Finish: Powder Coated, Yellow
- Design Factor: 5:1
- Identification: Trademark, Size/WLL, Batch Code, Grade
- Rated in Metric Ton(s)

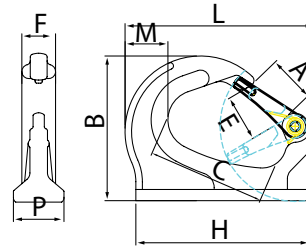

WLL (t)	Latch Kit		Dimensions (in)									Weld Bead X (mm)	Wt. (lb)	Box Qty.	Price / ea.	Part Number
	Price / ea.	Part Number	A	B	C	E	F	H	M	P	L					
3	41.79	3-3TWOHL	1.18	4.17	2.95	1.18	0.94	4.57	1.18	1.42	5.04	10	2.80	20	96.99	3-3TWOH
5	57.19	3-5TWOHL	1.54	5.24	3.86	1.42	1.10	6.30	1.69	1.71	6.69	10	5.95	9	201.44	3-5TWOH
8	57.73	3-8TWOHL	1.42	5.39	3.90	1.36	1.54	6.54	1.97	2.01	6.89	12	7.71	8	260.79	3-8TWOH
10	67.33	3-10TWOHL	1.93	6.65	5.51	1.93	1.50	8.07	2.17	2.09	8.74	15	11.46	6	387.97	3-10TWOH
20	159.06	3-20TWOHL	2.48	7.56	3.23	2.48	2.01	11.50	3.07	3.35	11.50	15	25.35	2	580.95	3-20TWOH

Welding Instructions

The welding should only be carried out by qualified welder according to Standards, e.g. EN 287 or AWS.

Support Material

- The support material ST 52-3.
- Prior to welding, the contact areas must be free from impurities, oil, paint, rust, scale, etc., for example by grinding.
- If the surface is at all corroded, all rust must be completely removed from the weld area. Painted surface must be prepared in the same way.
- The steel support member must have a carbon content of no less than 0.25% and no more than 0.40%.
- The hook must be positioned that the weld is loaded only in shear. No bending moment can be permitted on weld seam.
- In ambient temperature of 10°C and below, pre-heating of the weld area prior to welding must be carried out.

Seam Welding

- The welds must be sufficiently strong to take the required loads.
- A minimum weld-seam width must be maintained to give adequate weld strength (see table).
- The gauging points on the supports guarantee the gap necessary for the root pass (approx. 3mm).

- Start both, the root pass and final weld pass from the centre of the support to be welded.
- Before starting the final weld pass, clean well the root pass to avoid inclusions.
- The complete welding operation must be carried out continuously so that the parts do not have time to cool.

MIG Arc Welding

- Wire diameter 0.8 - 1.2 as per DIN 8559-SG 3.
- Important: do not weld in the open air during bad weather.

Manual Electric: Direct Current Supply Welding:

- Electrodes according to EN ISO 2560-A - E 42 6 B 3 2, AWS A 5.5: E 8018-G.
- Electrode: root pass & final weld pass, type E5154 B10 as per DIN 1913, used in accordance with the manufacturers.

Alternating current supply welding:

- Electrode as per DIN 1913, modified for alternating current use.
- HV welding and final weld pass, type E5155 B10.

RING - WELD ON LIFTING POINT, GRADE 80, OCEAN® BRAND

- Material: Alloy Steel, Grade 80
- Standard: EN 1677-1
- Finish: Powder Coated, Yellow
- Design Factor: 5:1
- Identification: Trademark, Size/WLL, Batch Code, Grade
- Rated in Metric Ton(s)

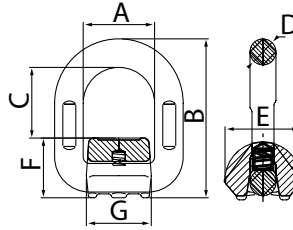

WLL (t)	Dimensions (in)							Wt. (lb)	Qty. / Box	Price / ea.	Part Number
	A	B	C	D	E	F	G				
1	1.61	3.15	1.38	0.51	1.50	1.32	1.46	1.04	50	29.68	3-057-1T
3	1.81	3.78	1.65	0.67	1.69	1.46	1.73	1.52	30	47.99	3-057-3T
5	2.17	4.76	1.89	0.87	2.40	1.97	1.97	3.22	20	80.20	3-057-5T
8	2.76	5.67	2.44	1.04	2.78	2.13	2.60	5.55	10	97.22	3-057-8T
10	3.35	6.61	3.07	1.10	2.99	2.46	3.07	7.91	8	130.65	3-057-10T
15	3.82	7.36	3.39	1.34	3.54	2.83	3.54	12.76	4	265.85	3-057-15T

Welding Instructions

The welding should only be carried out by qualified welder according to Standards, e.g. EN 287 or AWS

Support Material:

- Material of the welding block is S355J2+N (1.0577+N, St 52-3N, B.S. 4360.50D, AISI 1019 etc.).
- Prior to welding, the contact areas must be free from impurities, oil, paint, rust, scale, etc., for example by grinding. If the surface is at all corroded, all rust must be completely removed from the weld area.
- Painted surface must be prepared in the same way.
- The steel support member must have a carbon content of no less than 0.25% and no more than 0.40%.
- In ambient temperature of 10°C and below, pre-heating of the weld area prior to welding must be carried out.

Seam Welding:

- The welds must be sufficiently strong to take the required loads.
- The distance lugs assist in achieving the required root weld (approx. 3 mm).
- A minimum weld-seam width must be maintained to give adequate weld strength (see table).
- Start both, the root pass and final weld pass from the centre of the support to be welded.
- Before starting the final weld pass, clean well the root pass to avoid inclusions.

- The complete welding operation must be carried out continuously so that the parts do not have time to cool.
- Do not weld at the yellow powder coated tempered load ring.
- After welding, ensure bail pivots full 180° without interfering with the weld.

Effects of Temperature:

- The lifting points for weld on, types DAA, can together with the load (e.g. weld construction) be annealed.
- Temperature < 600° C, stress-release without reduction of WLL.
- The complete construction can be annealed stress release at < 600°C without reduction of WLL.
- Do not rapidly cool the weld.
- A thorough inspection of the weld should be performed. No cracks, pitting, inclusions, notches or undercuts are allowed. If doubt exists, use a suitable NDT method, such as magnetic particle or liquid penetrant to verify.
- If repair is required, grind out the defect and re-weld using the original qualified procedure.

SWIVEL - LIFTING EYE KEY POINT - UNC THREAD, GRADE 80, OCEAN® BRAND

- Material: Alloy Steel, Grade 80
- Standard: EN 1677-1, Bolt: ANSI B18.3.1M, ISO 4762
- Finish: Powder Coated, Yellow
- Design Factor: 4:1
- Identification: Trademark, Size/WLL, Batch Code, Grade
- Rated in Metric Ton(s)

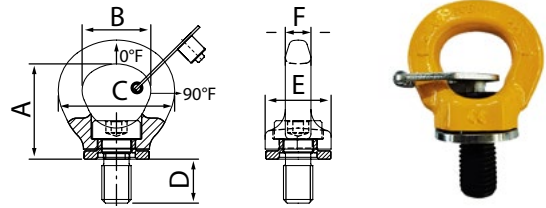



# of Leg	Load Direction	Part No.	Thread (in)	WLL (t)											
				1	2	1	2	2	2	2	3-4	3-4	3-4		
				0°	0°	90°	90°	0-45°	45-60°	unsym.	0-45°	45-60°	unsym.		
3-292K-003	5/16	1	2	0.3	0.6	0.42	0.3	0.3	0.63	0.45	0.3				
3-292K-004	3/8	1	2	0.4	0.8	0.56	0.4	0.4	0.8	0.6	0.4				
3-292K-007	1/2	2	4	0.75	1.5	1	0.75	0.75	1.5	1.1	0.75				
3-292K-015	5/8	4	8	1.5	3	2.1	1.5	1.5	3.1	2.2	1.5				
3-292K-023	3/4	6	12	2.3	4.6	3.2	2.3	2.3	4.8	3.4	2.3				
3-292K-025	7/8	6	12	2.3	4.6	3.2	2.3	2.3	4.8	3.4	2.3				
3-292K-032	1	8	16	3.2	6.4	4.5	3.2	3.2	6.7	4.8	3.2				
3-292K-045	1 1/4	12	24	4.5	9	6.3	4.5	4.5	9.4	6.7	4.5				
3-292K-070	1 1/2	16	32	7	14	9.8	7	7	14.7	10.5	7				
3-292K-090	1 3/4	24	48	9	18	12.6	9	9	18.9	13.5	9				
3-292K-120	2	32	64	12	24	16.8	12	12	25	18	12				

WLL (t)		Thread		Dimensions (in)						Torque (Nm)	Wt./ea. (lb)	Box Qty.	Price / ea.	Part Number
0°	90°	Size	Pitch UNC	A	B	C	D	E	F					
0.8	0.3	5/16	18	1.50	1.02	1.78	0.45	0.98	0.31	6~10	0.24	150	49.17	3-292K-003
1	0.4	3/8	16	1.50	1.02	1.78	0.55	0.98	0.31	6~10	0.26	150	52.26	3-292K-004
2	0.75	1/2	13	1.71	1.26	2.13	0.67	1.30	0.39	10~15	0.44	100	67.89	3-292K-007
4	1.5	5/8	11	2.05	1.48	2.50	0.94	1.42	0.55	20~30	0.77	60	78.61	3-292K-015
6	2.3	3/4	10	2.48	1.75	3.09	1.18	1.87	0.81	50~70	1.45	30	114.31	3-292K-023
8	3.2	7/8	9	2.91	2.03	3.62	1.39	2.09	0.79	120~150	2.42	20	126.80	3-292K-025
12	4.5	1	8	3.62	2.56	4.65	1.77	2.68	0.94	200~250	4.56	10	191.26	3-292K-032
16	7	1 1/4	7	4.13	2.99	5.35	2.24	3.23	1.18	280~400	8.82	6	314.63	3-292K-045

SWIVEL - LIFTING EYE KEY POINT, METRIC THREAD, GRADE 80, OCEAN® BRAND

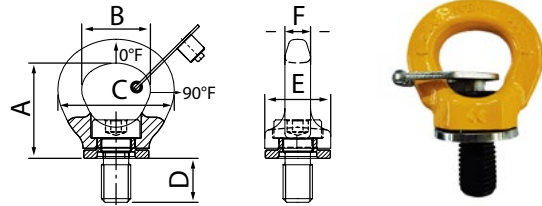
- Material: Alloy Steel, Grade 80
- Standard: EN 1677-1, Bolt: ANSI B18.3.1M, ISO 4762
- Finish: Powder Coated, Yellow
- Design Factor: 4:1
- Identification: Trademark, Size/WLL, Batch Code, Grade
- Rated in Metric Ton(s)

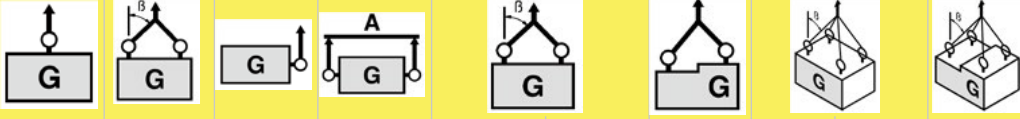

# of Leg Load Direction													
		1	2	1	2	2	2	2	3-4	3-4	3-4		
Part No.	Thread (mm)	WLL (t)											
3-291K-003	M8	1	2	0.3	0.6	0.42	0.3	0.3	0.63	0.45	0.3		
3-291K-004	M10	1	2	0.4	0.8	0.56	0.4	0.4	0.8	0.6	0.4		
3-291K-007	M12	2	4	0.75	1.5	1	0.75	0.75	1.5	1.1	0.75		
3-291K-015	M16	4	8	1.5	3	2.1	1.5	1.5	3.1	2.2	1.5		
3-291K-023	M20	6	12	2.3	4.6	3.2	2.3	2.3	4.8	3.4	2.3		
3-291K-032	M24	8	16	3.2	6.4	4.5	3.2	3.2	6.7	4.8	3.2		
3-291K-045	M30	12	24	4.5	9	6.3	4.5	4.5	9.4	6.7	4.5		
3-291K-070	M36	16	32	7	14	9.8	7	7	14.7	10.5	7		
3-291K-090	M42	24	48	9	18	12.6	9	9	18.9	13.5	9		
3-291K-120	M48	32	64	12	24	16.8	12	12	25	18	12		
3-291K-140	M56	34	68	16	32	22.4	16	16	32	24	16		
3-291K-150	M64	36	72	18	36	25.2	18	18	36	27	18		

WLL (t)		Thread		Dimensions (in)						Torque (Nm)	Wt./ea. (lb)	Box Qty.	Price / ea.	Part Number
0°	90°	Size	Pitch UNC	A	B	C	D	E	F					
0.8	0.3	M8	1.25	38.0	26.0	45.3	11.5	25.0	8.0	6~10	0.11	150	49.17	3-291K-003
1	0.4	M10	1.5	38.0	26.0	45.3	14.0	25.0	8.0	6~10	0.12	150	52.26	3-291K-004
2	0.75	M12	1.75	43.5	32.0	54.0	17.0	33.0	10.0	10~15	0.20	100	59.66	3-291K-007
4	1.5	M16	2	52.0	37.5	63.5	24.0	36.0	14.0	20~30	0.35	60	69.14	3-291K-015
6	2.3	M20	2.5	63.0	44.5	78.5	30.0	47.5	20.6	50~70	0.66	30	98.51	3-291K-023
8	3.2	M24	3	74.0	51.6	92.0	35.3	53.0	20.0	120~150	1.10	20	120.61	3-291K-032
12	4.5	M30	3.5	92.0	65.0	118.0	45.0	68.0	24.0	200~250	2.07	10	180.12	3-291K-045
16	7	M36	4	105.0	76.0	136.0	56.8	82.0	30.0	280~400	4	6	299.33	3-291K-070



- All swivel Hoist Rings meet or exceed all the requirements of ASME B30.26
- Hoist Ring Bail are designed by forged alloy steel, quenched and tempered
- Each forged part and cap screw have batch coding and are linked to test certificate sheet
- Hoist rings are 360° swivel with 180° pivot function
- Bolt galvanized alternative phosphate treatment
- 20,000 cycle fatigue rated to 1.5 times WLL
- Rated 100% at 90° angle
- 100% magnaflux crack detection
- Self aligns in direction of load

SWIVEL - HOIST RING, UNC THREAD, GRADE 80, OCEAN® BRAND

- Material: Alloy Steel, Grade 80
- Standard: ASME B30.26, Bolt: ASTM A574
- Finish: Dacromet Coating
- Design Factor: 5:1
- Identification: Trademark, Size/WLL, Batch Code, Grade

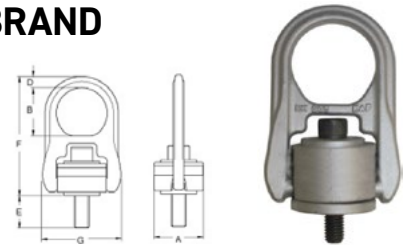

WLL (lb)	Thread Size	Torque ft. (lb)	Dimensions (in)						Wt./ea. (lb)	Box Qty.	Swivel Hoist Ring	
			A	B	D	E	F	G			Price / ea.	Part Number
800	5/16"-18 x 2	7	1.57	1.61	0.35	0.71	4.02	2.56	0.9	35	66.40	3-204-004
1000	3/8"-16 x 2	12	1.57	1.61	0.35	0.71	4.02	2.56	0.9	35	71.99	3-204-005
2500	1/2"-13 x 2.5	28	2.56	2.32	0.59	0.75	6.26	4.13	3.7	10	158.06	3-204-010
2500	1/2"-13 x 3.0	28	2.56	2.32	0.59	1.26	6.26	4.13	3.7	10	174.48	3-204-010L
4000	5/8"-11 x 2.5	60	2.56	2.32	0.59	0.74	6.26	4.13	4.0	10	174.48	3-204-019
4000	5/8"-11 x 3.25	60	2.56	2.32	0.59	1.69	6.26	4.13	4.0	10	203.83	3-204-019L
5000	3/4"-10 x 2.75	100	2.56	2.32	0.59	1.18	6.26	4.13	4.0	10	187.04	3-204-021
5000	3/4"-10 x 3.25	100	2.56	2.32	0.59	1.65	6.26	4.13	4.2	10	209.35	3-204-021L
7000	3/4"-10 x 3.0	100	3.35	2.87	0.87	0.79	8.03	5.28	9.0	4	364.10	3-204-030
7000	3/4"-10x3.75	100	3.35	2.87	0.87	1.75	8.03	5.28	9.1	4	401.95	3-204-030L
8000	7/8"-9 x 3.5	160	3.35	2.87	0.87	1.43	8.03	5.28	9.3	4	403.27	3-204-042
8000	7/8"-9 x 4.25	160	3.35	2.87	0.87	2.37	8.03	5.28	9.7	4	407.44	3-204-042L
10 000	1"-8 x 3.5	230	3.35	2.87	0.87	1.36	8.03	5.28	9.5	4	417.23	3-204-045
10 000	1"-8 x 4.5	230	3.35	2.87	0.87	2.36	8.03	5.28	9.7	4	460.97	3-204-045L
15 000	1-1/4"-7x4.5	470	3.95	3.15	1.0	2.25	8.58	6.30	14.5	2	551.26	3-204-070
24 000	1-1/2" - 6 x 6.5	800	4.72	4.29	1.38	2.17	12.09	8.66	36.4	2	1165.04	3-204-125
30 000	2" - 4.5 x 6.5	1100	4.72	4.29	1.38	3.01	12.09	8.66	38.6	2	1206.09	3-204-135

- Minimum Ultimate Load is 5 times the Working Load Limit
- Proof Load is 2.5 times the Working load Limit
- The depth of thread needs to be a minimum of 1 times the thread diameter for steel, 1.25 times for cast iron, 2 times for aluminium

SWIVEL - HOIST RING, UNC THREAD (OCEAN), GRADE 80

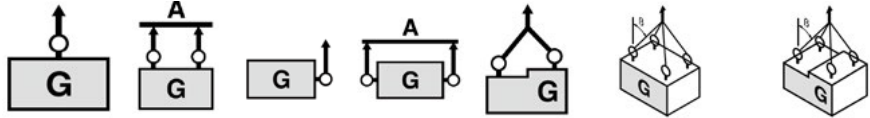

# of Leg Load Direction	Item No.		1		2		1		2		2		3-4		3-4	
			0°	0°	90°	90°	45-60°	unsym.	45-60°	unsym.						
	Thread (in)	WLL (lb)														
3-204-004	5/16	800	800	1600	800	1600	800	1600	800	800	1200	800				
3-204-005	3/8	1000	1000	2000	1000	2000	1000	2000	1000	1000	1500	1000				
3-204-010	1/2	2500	2500	5000	2500	5000	2500	5000	2500	2500	3750	2500				
3-204-010L	1/2	2500	2500	5000	2500	5000	2500	5000	2500	2500	3750	2500				
3-204-019	5/8	4000	4000	8000	4000	8000	4000	8000	4000	4000	6000	4000				
3-204-019L	5/8	4000	4000	8000	4000	8000	4000	8000	4000	4000	6000	4000				
3-204-021	3/4	5000	5000	10000	5000	10000	5000	10000	5000	5000	7500	5000				
3-204-021L	3/4	5000	5000	10000	5000	10000	5000	10000	5000	5000	7500	5000				
3-204-030	3/4	7000	7000	14000	7000	14000	7000	14000	7000	7000	10500	7000				
3-204-042	7/8	8000	8000	16000	8000	16000	8000	16000	8000	8000	12000	8000				
3-204-042L	7/8"	8000	8000	16000	8000	16000	8000	16000	8000	8000	12000	8000				
3-204-045	1"	10000	10000	20000	10000	20000	10000	20000	10000	10000	15000	10000				
3-204-045L	1"	10000	10000	20000	10000	20000	10000	20000	10000	10000	15000	10000				
3-204-070	1-1/4"	15000	15000	30000	15000	30000	15000	30000	15000	15000	22500	15000				
3-204-125	1-1/2"	24000	24000	48000	24000	48000	24000	48000	24000	24000	36000	24000				
3-204-135	2"	30000	30000	60000	30000	60000	30000	60000	30000	30000	45000	30000				



- All Swivel Hoist Rings meet or exceed all the requirements of ASME B30.26
- Bolts are metric thread ASME / ANSI B18.3.1 M
- Hoist Ring Bail are designed by forged alloy steel, quenched and tempered
- Each forged part and cap screw have batch coding and are linked to test certificate sheet
- Hoist rings are 360° swivel with 180° pivot function
- Bolt galvanized alternative phosphate treatment
- 20,000 cycle fatigue rated to 1.5 times WLL
- Rated 100% at 90° angle
- 100% magnaflux crack detection
- Self-aligns in direction of load

SWIVEL - HOIST RING, METRIC THREAD, GRADE 80, OCEAN® BRAND

- Material: Alloy Steel, Grade 80
- Standard: ASME B30.26, Bolt: ASTM A574
- Finish: Dacromet Coated
- Design Factor: 5:1
- Identification: Trademark, Size/WLL, Batch Code, Grade
- Rated in Metric Ton(s)

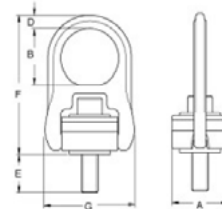

WLL (t)	Thread Size	Torque (Nm)	Dimensions (mm)						Wt./ea. (kg)	Box Qty.	Swivel Hoist Ring	
			A	B	D	E	F	G			Price /ea.	Part Number
0.40	M8-1.25 x 50	10	40	41	9	17	102	65	0.4	35	66.40	3-203-004
0.45	M10-1.50 x 45	16	40	41	9	11	102	65	0.5	35	71.99	3-203-005
0.45	M10-1.50 x 60	16	40	41	9	26	102	65	0.5	35	100.12	3-203-005L
1.05	M12-1.75 x 60	38	65	64	15	15	158	105	1.7	10	158.06	3-203-010
1.05	M12-1.75 x 75	38	65	64	15	30	158	105	1.7	10	174.48	3-203-010L
1.90	M16-2.00 x 65	81	65	64	15	20	158	105	1.8	10	174.48	3-203-019
1.90	M16-2.00 x 80	81	65	64	15	35	158	105	1.8	10	203.83	3-203-019L
2.15	M20-2.50 x 70	136	65	64	15	25	158	105	1.9	10	187.04	3-203-021
2.15	M20-2.50 x 90	136	65	64	15	45	158	105	2.1	10	209.35	3-203-021L
3.00	M20-2.50 x 80	136	85	79	19	25	204	134	4.2	4	364.10	3-203-030
4.20	M24-3.00 x 80	312	85	79	19	26	204	134	4.2	4	417.23	3-203-042
4.20	M24-3.00 x 105	312	85	79	19	56	204	134	4.3	4	460.97	3-203-042L
7.00	M30-3.50 x 135	637	100	100	25	81	241	160	6.7	2	551.26	3-203-070
11.00	M36-4.00 x 160	1005	120	111	30	76	286	194	15.5	2	1169.39	3-203-110
12.50	M42-4.50 x 175	1005	120	111	30	65	286	194	16.5	2	1165.04	3-203-125
13.50	M48-5.00 x 190	1350	120	111	30	70	286	194	16.8	2	1206.09	3-203-135

- Minimum Ultimate Load is 5 times the Working Load Limit
- Proof Load is 2.5 times the Working load Limit
- The depth of thread needs to be a minimum of 1 times the thread diameter for steel, 1.25 times for cast iron, 2 times for aluminum

SWIVEL - HOIST RING, UNC THREAD (OCEAN), GRADE 80

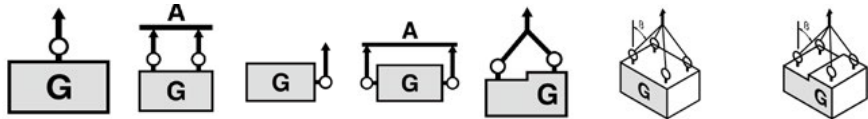

# of Leg Load Direction	Item No.		Thread (in)	WLL (T)	1	2	1	2	2	3-4	3-4	
					0°	0°	90°	90°	45-60°	unsym.	45-60°	unsym.
	3-203-004		M 8	0.40	0.40	0.80	0.40	0.8	0.40	0.40	0.60	0.40
	3-203-005		M 10	0.45	0.45	0.90	0.45	0.9	0.45	0.45	0.68	0.45
	3-203-010		M 12	1.05	1.05	2.10	1.05	2.1	1.05	1.05	1.58	1.05
	3-203-010L		M 12	1.05	1.05	2.10	1.05	2.1	1.05	1.05	1.58	1.05
	3-203-019		M 16	1.90	1.90	3.80	1.90	3.8	1.90	1.90	2.85	1.90
	3-203-019L		M 16	1.90	1.90	3.80	1.90	3.8	1.90	1.90	2.85	1.90
	3-203-021		M 20	2.15	2.15	4.30	2.15	4.3	2.15	2.15	3.23	2.15
	3-203-021L		M 20	2.15	2.15	4.30	2.15	4.3	2.15	2.15	3.23	2.15
	3-203-030		M 20	3.00	3.00	6.00	3.00	6	3.00	3.00	4.50	3.00
	3-203-042		M 24	4.20	4.20	8.40	4.20	8.4	4.20	4.20	6.30	4.20
	3-203-042L		M 24	4.20	4.20	8.40	4.20	8.4	4.20	4.20	6.30	4.20
	3-203-070		M 30	7.00	7.00	14.00	7.00	14	7.00	7.00	10.50	7.00
	3-203-110		M 36	11.00	11.00	22.00	11.00	22	11.00	11.00	16.50	11.00
	3-203-125		M 42	12.50	12.50	25.00	12.50	25	12.50	12.50	18.75	12.50
	3-203-135		M 48	13.50	13.50	27.00	13.50	27	13.50	13.50	20.25	13.50

Rated in Metric Ton(s)

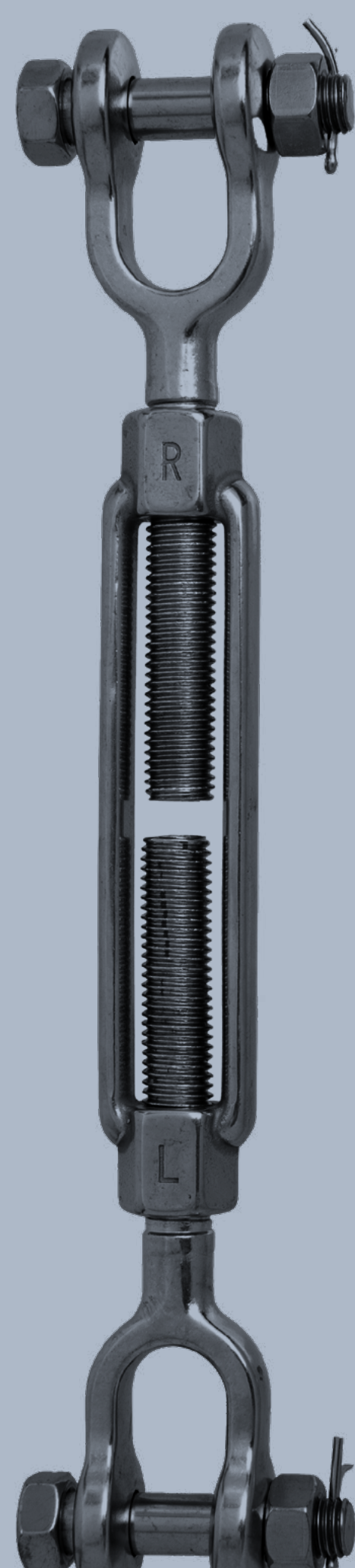
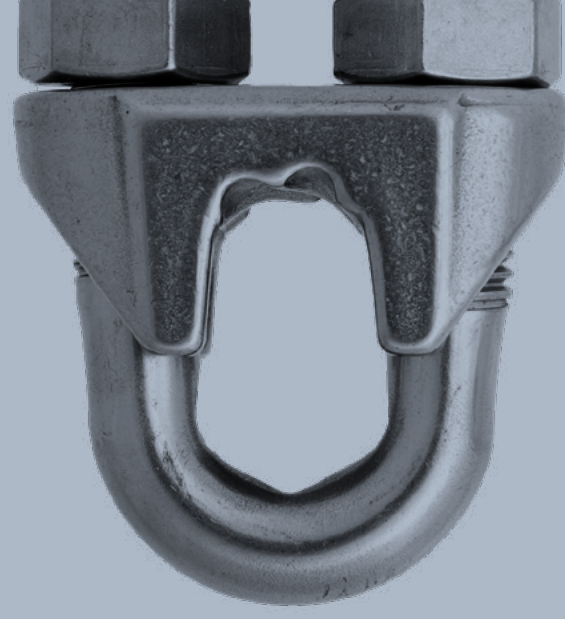

RIGGING HARDWARE & EQUIPMENT

Shackles.....	53 - 69
Turnbuckles.....	70 - 79
Eye Bolts, Eye Nuts, & Pad Eyes.....	80 - 87
DNV Master Links & Quad Assemblies.....	88 - 89
Pear Links, Master Links & Round Rings....	90 - 91
Twin Clevis & Quick Links, Snap & S Hooks.....	92 - 93
Swivels.....	94 - 100
Wire Rope & Synthetic Blocks.....	101 - 111
Load Cells.....	112 - 114
Hooks.....	115 - 126



SHACKLE - DEE (CHAIN) TRAWLING, WITH SQUARE HEAD SCREW PIN

Dimensions approximate.

Commercial grade trawling chain shackles are inexpensive shackles used for trawling applications, NOT for bearing critical loads.

Not for overhead lifting, Non load rated Shackle.

*Pin Size: Large diameter size available while quantities last.

- Material: Mild Steel
- Finish: Self Coloured Black



Small Pin Diameter:

Shackle Size (in)	Qty. / Bag	Inside Length (in)	Inside Width (in)	Pin Diameter (in)	Tolerance + / - (in)		Wt./ea. (lb)	Price / ea.	Part Number
					Length	Width			
3/8	300	1 1/4	11/16	3/8	1/8	1/16	0.26	1.33	6-3/8"SCTD
1/2	150	1 5/8	13/16	1/2	1/8	1/16	0.49	1.82	6-1/2"SCTD
5/8	70	2	1 1/16	5/8	1/8	1/16	1.10	4.10	6-5/8"SCTD

SHACKLE - DEE (CHAIN) TRAWLING, WITH SQUARE HEAD SCREW PIN

High tensile steel D-trawl shackles with square head pin. Not for overhead lifting.

- Material: High Tensile Steel
- Finish: Painted Yellow
- Design Factor: 4:1
- Identification: Size/WLL
- Rated in Metric Ton(s)



WLL (t)	Size (in)	Price / ea.	Part Number
2	1/2	10.77	6-1/2S2131SH
3-1/4	5/8	21.13	6-5/8S2131SH
4-3/4	3/4	22.49	6-3/4S2131SH
6-1/2	7/8	42.02	6-7/8S2131SH
8-1/2	1	63.79	6-1S2131SH
9-1/2	1 1/8	80.60	6-11/8S2131SH
12	1 1/4	118.14	6-11/4S2131SH

SHACKLE - DEE (CHAIN), WITH SCREW PIN

- Material: High Tensile Steel
- Finish: Body:Galvanized, Pin: Yellow Painted
- Design Factor: 6:1
- Identification: Size/WLL
- Rated in Metric Ton(s)



Size (in)	WLL (t)	Wt./ea. (lb)	Dimensions (in)						Price / ea.	Part Number
			Gap	Pin	Stock	In. Length	Palm	Pin Length		
1/4	1/2	0.12	0.47	0.31	0.25	0.88	0.61	1.38	3.15	6-1/4"SP
5/16	3/4	0.17	0.53	0.38	0.31	1.03	0.75	1.66	4.42	6-5/16"SP
3/8	1	0.25	0.66	0.44	0.38	1.25	0.91	2.03	5.81	6-3/8"SP
1/2	2	0.70	0.81	0.63	0.50	1.63	1.19	2.69	8.71	6-1/2"SP
5/8	3-1/4	1.24	1.06	0.75	0.63	2.00	1.56	3.34	16.40	6-5/8"SP
3/4	4-3/4	2.18	1.25	0.88	0.81	2.38	1.88	3.97	29.66	6-3/4"SP
7/8	6-1/2	3.28	1.44	1.00	0.97	2.81	2.13	4.50	43.04	6-7/8"SP
1	8-1/2	4.80	1.69	1.13	1.00	3.19	2.38	5.07	62.15	6-1"SP

SEE WARNING AND APPLICATION INFORMATION AT END OF SHACKLE SECTION

SHACKLE - COMMERCIAL BOW, ANCHOR, WITH SCREW PIN

- Material: Mild Steel
- Finish: Galvanized

Commercial grade shackles are inexpensive shackles used for non critical applications.
NOT for overhead lifting, NOT for bearing critical loads.

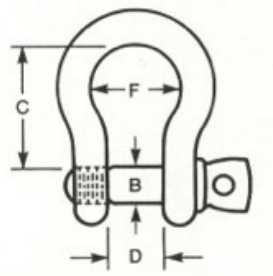

Nominal Size (in)	Weight / ea. (lb)	Body Dia. (in)	Dimensions (in)				Price / ea.	Part Number
			B	C	D	F		
3/16	0.04	0.20	0.21	0.92	0.38	0.61	1.07	6-3/16"GCS
1/4	0.08	0.23	0.28	1.15	0.51	0.70	1.39	6-1/4"GCS
5/16	0.14	0.30	0.36	1.27	0.55	0.82	1.82	6-5/16"GCS
3/8	0.26	0.37	0.44	1.56	0.60	0.97	3.01	6-3/8"GCS
7/16	0.36	0.42	0.46	1.67	0.72	1.00	4.72	6-7/16"GCS
1/2	0.64	0.50	0.60	1.95	0.77	1.32	5.43	6-1/2"GCS
5/8	1.16	0.60	0.75	2.37	1.12	1.70	10.67	6-5/8"GCS
3/4	1.96	0.75	0.82	2.90	1.29	1.93	18.13	6-3/4"GCS
7/8	3.16	0.87	0.98	3.31	1.42	2.20	25.11	6-7/8"GCS
1	4.20	1.00	1.06	3.75	1.58	2.73	32.66	6-1"GCS

SEE WARNING AND APPLICATION INFORMATION AT END OF SHACKLE SECTION

SHACKLE - BOW, ANCHOR, WITH SCREW PIN

- Material: 316 Stainless Steel, Forged
- Finish: Stainless Steel
- Design Factor: 4:1
- Identification: Size/WLL
- Rated in Metric Ton(s)

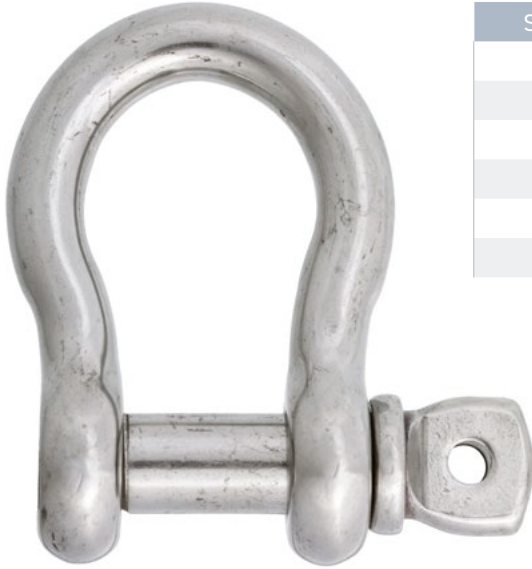

Size (in)	WLL (t)	Qty. / Box	Price / ea.	Part Number
1/4	1/2	300	7.25	6-1/4"SSFB
5/16	3/4	250	9.95	6-5/16"SSFB
3/8	1	150	15.87	6-3/8"SSFB
1/2	2	60	26.41	6-1/2"SSFB
5/8	3-1/4	40	62.30	6-5/8"SSFB
3/4	4-3/4	20	110.30	6-3/4"SSFB

SHACKLE - BOW, ANCHOR, WITH SCREW PIN

- Material: 304 Stainless Steel
- Finish: Stainless Steel
- Identification: Size



Size (in)	Qty. / Box	Price / ea.	Part Number
1/4	300	5.68	6-1/4"SSBOW
5/16	300	6.56	6-5/16"SSBOW
3/8	150	9.53	6-3/8"SSBOW
1/2	100	21.80	6-1/2"SSBOW
5/8	50	52.93	6-5/8"SSBOW
3/4	30	78.25	6-3/4"SSBOW

SEE WARNING AND APPLICATION INFORMATION AT END OF SHACKLE SECTION



SHACKLE - BOW, ANCHOR, WITH SCREW YELLOW PIN®

Trademark - Yellow Pin® Shackle - Registration Number: TMA 862,758

Identification / Marking:

Shackle Body:

- Name or trademark of manufacturer "OCEAN"
- Size
- WLL (Working Load Limit)

Shackle Bolt:

- Name of trademark of manufacturer "OC"
- Grade, material type "HS"
- Powder Coated "Yellow Pin®" for instant recognition

Additional Identification:

- Shackle Production Code
 - Traceable to certificate & material

Manufacturing/Design Information:

- Manufactured to Federal Specification RR-C-271D, Type IVA, Grade A, Class 2.
- Meet and/or exceeds ASME B30.26
- Safety/Design Factor: 6:1
- Material: High Tensile Steel, Forged
 - Quenched and Tempered, Grade 6.

Coating / Protection:

- Hot dip galvanized & yellow pin powder coated.

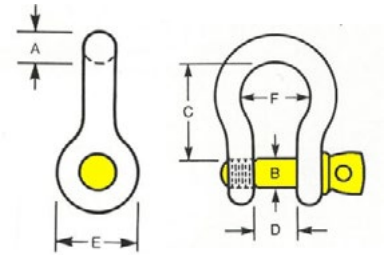

Rated in Metric Ton(s)

Size (in)	WLL (t)	Dimensions (in)						Weight/ea. (lb)	Qty. / Box	Price / ea.	Part Number
		A	B	C	D	E	F				
3/16	1/3	0.19	0.25	0.88	0.38	0.56	0.60	0.06	1000	2.58	6-3/16"SPB
1/4	1/2	0.25	0.31	1.13	0.47	0.61	0.78	0.10	500	3.20	6-1/4"SPB
5/16	3/4	0.31	0.38	1.22	0.53	0.75	0.84	0.19	300	3.73	6-5/16"SPB
3/8	1	0.38	0.44	1.44	0.66	0.91	1.03	0.31	200	4.89	6-3/8"SPB
7/16	1 1/2	0.44	0.50	1.69	0.75	1.06	1.16	0.38	150	6.47	6-7/16"SPB
1/2	2	0.50	0.63	1.88	0.81	1.19	1.31	0.72	80	8.28	6-1/2"SPB
5/8	3 1/4	0.63	0.75	2.38	1.06	1.50	1.69	1.37	40	14.18	6-5/8"SPB
3/4	4 3/4	0.75	0.88	2.81	1.25	1.81	2.00	2.35	25	22.70	6-3/4"SPB
7/8	6 1/2	0.88	1.00	3.31	1.44	2.09	2.28	3.62	15	33.26	6-7/8"SPB
1	8 1/2	1.00	1.13	3.75	1.69	2.38	2.69	5.03	10	47.39	6-1"SPB
1-1/8	9 1/2	1.16	1.25	4.25	1.81	2.69	2.91	7.41	6	70.85	6-1-1/8"SPB
1-1/4	12	1.29	1.38	4.69	2.03	3.00	3.25	9.50	5	95.01	6-1-1/4"SPB
1-3/8	13 1/2	1.42	1.50	5.25	2.25	3.31	3.63	13.53	4	128.81	6-1-3/8"SPB
1-1/2	17	1.54	1.63	5.75	2.38	3.63	3.88	17.20	3	164.77	6-1-1/2"SPB
1-3/4	25	1.84	2.00	7.00	2.88	4.19	5.00	27.78	2	284.71	6-1-3/4"SPB
2	35	2.08	2.25	7.75	3.25	4.81	5.75	45.00	2	455.68	6-2"SPB
2-1/2	55	2.71	2.75	10.50	4.13	5.69	7.25	85.75	1	884.60	6-2-1/2"SPB

Note: Each production code represents the forging batch. All pins and bodies are interchangeable for that batch. Pin and Bodies are not interchangeable between alternate batches.

SHACKLE - BOW, ANCHOR, WITH BOLT AND NUT YELLOW PIN®

Trademark - Yellow Pin® Shackle - Registration Number: TMA 862,758

Identification / Marking:

Shackle Body:

- Name or trademark of manufacturer "OCEAN"
- Size
- WLL (Working Load Limit).

Shackle Bolt:

- Name of trademark of manufacturer "OC"
- Grade, material type "HS"
- Powder Coated "Yellow Pin®" for instant recognition

Additional Identification:

- Shackle Production Code
 - Traceable to certificate & material

Manufacturing/Design Information:

- Manufactured to Federal Specification RR-C-271D, Type IVA, Grade A, Class 3.
- Meet and/or exceeds ASME B30.26
- Safety/Design Factor: 6:1
- Material: High Tensile Steel, Forged
 - Quenched and Tempered, Grade 6.

Coating / Protection:

- Hot dip galvanized & yellow pin powder coated.

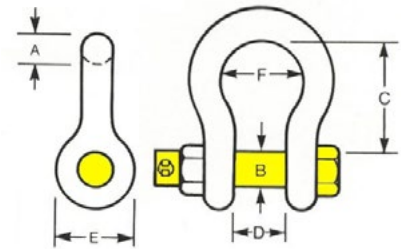

Size (in)	WLL (t)	Dimensions (in)						Pin length (in)	Wt./ea. (lb)	Qty. / Box	Price / ea.	Part Number
		A	B	C	D	E	F					
1/4	1/2	0.25	0.31	1.13	0.47	0.61	0.78	1.56	0.11	500	3.61	6-1/4"SA
5/16	3/4	0.31	0.38	1.22	0.53	0.75	0.84	1.82	0.22	300	4.38	6-5/16"SA
3/8	1	0.38	0.44	1.44	0.66	0.91	1.03	2.17	0.33	200	5.96	6-3/8"SA
7/16	1-1/2	0.44	0.50	1.69	0.75	1.06	1.16	2.51	0.49	150	7.11	6-7/16"SA
1/2	2	0.50	0.64	1.88	0.81	1.19	1.31	2.80	0.79	80	9.04	6-1/2"SA
5/8	3 1/4	0.63	0.77	2.38	1.06	1.50	1.69	3.56	1.68	40	16.06	6-5/8"SA
3/4	4 3/4	0.75	0.89	2.81	1.25	1.81	2.00	4.15	2.72	25	24.98	6-3/4"SA
7/8	6 1/2	0.88	1.02	3.31	1.44	2.09	2.28	4.82	3.95	15	35.89	6-7/8"SA
1	8 1/2	1.00	1.15	3.75	1.69	2.38	2.69	5.39	5.66	10	52.23	6-1"SA
1-1/8	9 1/2	1.13	1.25	4.25	1.81	2.69	2.91	5.90	8.27	6	70.80	6-1-1/8"SA
1-1/4	12	1.29	1.40	4.69	2.03	3.00	3.25	6.69	11.71	5	95.01	6-1-1/4"SA
1-3/8	13 1/2	1.42	1.53	5.25	2.25	3.31	3.63	7.21	15.83	4	150.18	6-1-3/8"SA
1-1/2	17	1.53	1.66	5.75	2.38	3.63	3.88	7.73	20.80	3	177.39	6-1-1/2"SA
1-3/4	25	1.84	2.04	7.00	2.88	4.19	5.00	9.68	33.91	2	328.19	6-1-3/4"SA
2	35	2.08	2.30	7.75	3.25	4.81	5.75	10.81	52.25	2	511.11	6-2"SA
2-1/2	55	2.71	2.80	10.50	4.13	5.69	7.25	13.58	98.25	1	960.21	6-2-1/2"SA

Note: Each production code represents the forging batch. All pins and bodies are interchangeable for that batch. Pin and Bodies are not interchangeable between alternate batches.

SEE WARNING AND APPLICATION INFORMATION AT END OF SHACKLE SECTION

SHACKLE - WIDE BODY SLING, WITH BOLT AND NUT, YOKE® BRAND

- Material: Forged Alloy Steel with Alloy Pins/Bolts
- Standard: RR-C-271F, EN 13889
- Finish: Body: Powder Coated Blue, Bolt/Pin: Galvanized
- Design Factor: 5.4:1 (Ultimate Load)
- Identification: Trademark, Size/WLL, Batch Code
- 100% Magnaflux crack detection during manufacturing
- 20,000 cycle fatigue rated to 1.5 times working load limit

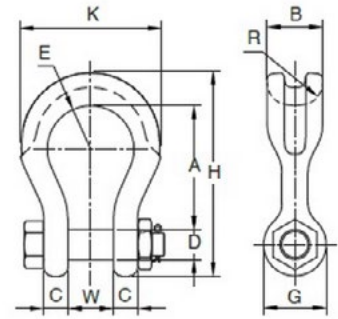

Size (in)	WLL (t)	Dimensions (in)										Wt./ea. (lb)	Price / ea.	Part Number
		A	B	C	D	E	G	H	K	R	W			
1	12.5	4.64	2.12	0.91	1.14	1.61	2.40	7.64	5.51	1.38	1.73	8.4	279.25	28-809-26
1-1/4	18	5.83	2.52	1.18	1.42	2.00	2.68	9.37	6.77	1.50	2.13	15	405.49	28-809-32

SHACKLE - WIDE BODY SLING, WITH BOLT AND NUT GREEN PIN®

- Material: Bow and pin alloy steel, Grade 8, quenched and tempered
- Standard: RR-C-271F, EN 13889
- Finish: Bow: Painted Silver, Bolt: Painted Green
- Design Factor: 5:1
- Identification: Trademark, Size/WLL, Batch Code
- Temperature Range: -20°C up to +200°C
- Van Beest is certified by DNV to DNV 2.7-1
- Van Beest mill in Holland is approved to DNV, ABS, Lloyd's & Germanischer Lloyd

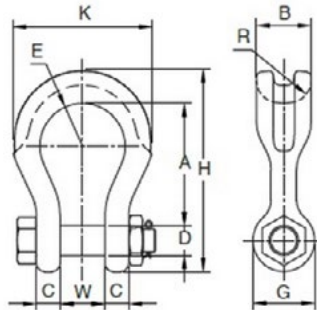

Item	WLL (t)	Dimensions (mm)										Wt./ea. (kg)	Price / ea.	Part Number
		A	B	C	D	E	G	H	K	W				
P-6033	12.5	120	54	25	28	82	61	197	146	44	4.13	619.81	25-12.5WBS	
P-6033	18	148	64	30	35	102	69	239	180	54	7.63	1417.20	25-18WBS	
P-6033	30	165	79	35	42	126	90	279	200	69	12.4	2004.55	25-30WBS	
P-6033	40	199	97	45	51	140	109	331	235	84	21.7	3406.70	25-40WBS	
P-6033	55	240	100	55	57	160	115	389	270	90	30	5629.03	25-55WBS	

SEE WARNING AND APPLICATION INFORMATION AT END OF SHACKLE SECTION

SHACKLE - SLING PROTECTOR, WITH BOLT AND NUT, GN®

- Material: Bow and pin alloy steel, quenched and tempered
- Standard: RR-C-271F, EN 13889
- Finish: Bow: Painted Grey
- Design Factor: 5:1
- Identification: Trademark, Size/WLL, Batch Code
- Certification: MPI, US, Witness DNV, Lloyd's, ABS, BV, etc. (on request)
- Temperature Range: -20°C up to +200°C
- Charpy impact testing performed at -40°C

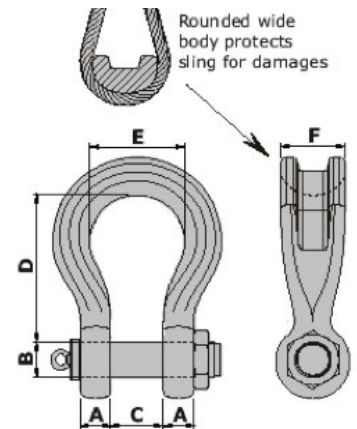

Rated in Metric Ton(s)

WLL (t)	Dimensions (mm)						Wt./ea. (kg)	Price / ea.	Part Number
	A	B	C	D	E	F			
75	70	70	105	290	185	120	45	6881.09	116-75WBS
125	80	80	130	365	220	150	120	11982.51	116-125WBS
150	90	95	140	390	250	170	160	17558.83	116-150WBS
200	105	105	150	480	275	205	230	21289.47	116-200WBS
250	110	120	170	550	300	240	320	Pricing on Request	116-250WBS
300	140	134	185	600	350	265	340		116-300WBS
400	160	160	220	600	370	320	620		116-400WBS
500	170	180	250	650	450	340	800		116-500WBS
600	180	200	275	720	490	370	960		116-600WBS
700	200	215	300	750	540	400	1250		116-700WBS
800	220	230	325	780	555	420	1400		116-800WBS
900	238	250	350	850	585	440	2100		116-900WBS
1000	240	270	380	850	615	460	2200		116-1000WBS
1250	260	300	430	930	645	530	2800		116-1250WBS
1500	280	320	460	950	680	560	3300	116-1500WBS	
2000	320	385	500	1050	680	600	4800	116-2000WBS	

SEE WARNING AND APPLICATION INFORMATION AT END OF SHACKLE SECTION

SHACKLE - BOW, WITH BOLT AND NUT, GN®

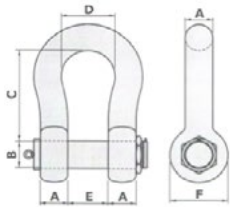

Type H9 & H10

- Material: ≤ 120 t: Forged High Tensile Steel.
> 120 t: Forged High Alloy Steel Bow and pin alloy steel, quenched and tempered
- Standard: RR-C-271F, EN 13889
- Finish: Painted Gray

- Design Factor: ≤ 85 t: 6:1. > 85 t: 5:1.
- Identification: Trademark, Size/WLL, Batch Code
- Temperature Range: -40°C up to +200°C
- Charpy impact testing performed at -40°C
- Rated in Metric Ton(s)

Tolerance ± 5%

WLL (t)	Design Factor	Dimensions (mm)						Wt./ea. (kg)	Price / ea.	Part Number
		A	B	C	D	E	F			
25	6:1	45	50	178	126	74	104	13	Pricing on Request	116-25SA
35	6:1	50	57	197	138	83	119	18		116-35SA
42.5	6:1	57	65	220	160	95	134	26		116-42.5SA
55	6:1	65	70	260	180	105	145	35		116-55SA
85	6:1	75	83	330	190	127	163	53		116-85SA
120	5:1	89	95	381	238	150	200	110	6571.51	116-120SA
150	5:1	102	108	400	275	170	230	160	10398.88	116-150SA
200	5:1	120	125	500	290	180	260	235	15578.37	116-200SA
250	5:1	125	140	540	305	200	260	285	Pricing on Request	116-250SA
300	5:1	135	150	600	305	200	305	340		116-300SA
400	5:1	165	175	650	325	225	350	560		116-400SA
500	5:1	175	185	700	350	250	370	685		116-500SA
600	5:1	195	205	700	375	275	405	880		116-600SA
700	5:1	205	215	700	400	300	435	980		116-700SA
800	5:1	210	220	700	400	300	435	1100		116-800SA
900	5:1	220	230	700	420	320	465	1280		116-900SA
1000	5:1	230	240	700	420	340	480	1460		116-1000SA

Cold Temperature application - General Information

There has been a lot of discussion in recent months about cold temperature shackles. There is a misconception that if a shackle complies with DNV 2.7-1 it is certified for cold temperature use and conforms to CAPP requirements. Use web site (<http://exchange.dnv.com/publishing/StdCert/Standard2-7-1.pdf>) to obtain a copy of DNV 2.7-1. DNV rules are written for the world not just the cold areas therefore why would a shackle used in the tropics have to have a cold temperature rating. DNV's material requirement is to have a minimum Charpy impact testing at the design working temperature see section 8.4. Make sure the shackle you are using has actually been tested at the working temperature you are using them. Most areas of Canada are going to require a temperature of minus 40°C and achieving a 42 jewel impact result. These parameters and results should be stated on

documentation, identification marking should link all documentation to the individual product. Based on EN10204 (3.1 or 3.2) primary and incoming material can be tested for standard compliance (section 4). Both of these standards are a requirement for CAPP. Be informed to make sure your inspection and documentation matches your client's expectations. We have two manufacturers who comply with DNV for Cold temperature results at -40°C, Van Beest (Polar shackle) and GN Rope Fittings. Also has shackles certified to DNV standards however not for cold temperature applications. We are able for an additional charge perform extra 3rd party laboratory testing on our stock lots should additional testing be required, these would be added as an appendix to the manufacturer's certificate of compliance and EN 10204 certificate that can be traced to the lot production.



- Made in Holland
- All shackles can be supplied with 3.1-B certificates
- Van Beest is certified by DNV to DNV 2.7-1
- Van Beest mill in Holland is approved to DNV, ABS, Lloyd's & Germanischer Lloyd

SHACKLE - BOW, ANCHOR, WITH SCREW GREEN PIN®

- Material: High Tensile Steel, Grade 6, quenched and tempered
- Standard: RR-C-271F, EN 13889
- Finish: Bow: Galvanized, Pin: Painted Green
- Design Factor: 6:1
- Identification: Trademark, Size/WLL, Batch Code
- Temperature Range: -40°C up to +200°C
- Rated in Metric Ton(s)

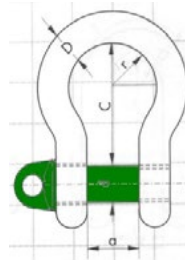

Item	WLL (t)	Size (in)	A (mm)	C (mm)	D (mm)	d (mm)	2r (mm)	Wt./ea. (kg)	Price / ea.	Part Number
G-4161	0.33	3/16	9.5	22	5	6	16	0.02	11.03	25-.33SP
G-4161	0.5	1/4	12	29	7	8	20	0.06	11.38	25-.5SP
G-4161	0.75	5/16	13.5	32	9	10	21	0.11	12.77	25-.75SP
G-4161	1	3/8	17	36.5	10	11	26	0.15	15.14	25-1SP
G-4161	1.5	7/16	18.5	43	11	12	29	0.21	19.26	25-1.5SP
G-4161	2	1/2	22	51	13.5	16	32	0.37	32.20	25-2SP
G-4161	3.25	5/8	27	64	16	19	43	0.65	50.30	25-3.25SP
G-4161	4.75	3/4	31	76	19	22	51	1.06	75.47	25-4.75SP
G-4161	6.5	7/8	36	83	22	25	58	1.56	113.39	25-6.5SP
G-4161	8.5	1	43	95	25	28	68	2.32	143.53	25-8.5SP
G-4161	9.5	1 1/8	47	108	28	32	75	3.28	228.25	25-9.5SP
G-4161	12	1 1/4	51	115	32	35	83	4.51	301.55	25-12SP
G-4161	13.5	1 3/8	57	133	35	38	92	5.93	338.97	25-13.5SP
G-4161	17	1 1/2	60	146	38	42	99	7.89	493.02	25-17SP
G-4161	25	1 3/4	74	178	45	50	126	13.40	817.10	25-25SP
G-4161	35	2	83	197	50	57	138	18.85	1048.33	25-35SP
G-4161	55	2-1/2	105	266.5	65	70	180	37.86	2126.36	25-55SP

SEE WARNING AND APPLICATION INFORMATION AT END OF SHACKLE SECTION



- Made in Holland
- All shackles can be supplied with 3.1-B certificates
- Van Beest is certified by DNV to DNV 2.7-1
- Van Beest mill in Holland is approved to DNV, ABS, Lloyd's & Germanischer Lloyd

SHACKLE - BOW, ANCHOR, WITH BOLT AND NUT GREEN PIN®

- Material: High Tensile Steel, Grade 6, quenched and tempered
- Standard: RR-C-271F, EN 13889
- Finish: Bow: Galvanized, Bolt: Painted Green
- Design Factor: 6:1
- Identification: Trademark, Size/WLL, Batch Code
- Temperature Range: -40°C up to +200°C
- Rated in Metric Ton(s)

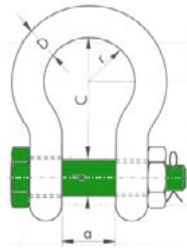

Item	WLL (t)	Size (in)	a (mm)	C (mm)	D (mm)	d-pin (mm)	2r (mm)	Wt./ea. (kg)	Price / ea.	Part Number
G-4163	0.75	5/16	13.5	32	9	10	22	0.11	14.91	25-75SA
G-4163	1	3/8	17	36.5	10	11	26	0.16	16.73	25-1SA
G-4163	1.5	7/16	19	43	11	13	14.5	0.22	19.22	25-1.5SA
G-4163	2	1/2	22	51	13.5	16	32	0.44	33.52	25-2SA
G-4163	3.25	5/8	27	64	16	19	43	0.79	55.33	25-3.25SA
G-4163	4.75	3/4	31	76	19	22	51	1.26	83.46	25-4.75SA
G-4163	6.5	7/8	36	83	22	25	58	1.88	116.34	25-6.5SA
G-4163	8.5	1	43	95	25	28	68	2.78	159.95	25-8.5SA
G-4163	9.5	1 1/8	47	108	28	32	75	3.87	224.98	25-9.5SA
G-4163	12	1 1/4	51	115	32	35	83	5.26	345.77	25-12SA
G-4163	13.5	1 3/8	57	133	35	38	92	6.94	381.57	25-13.5SA
G-4163	17	1 1/2	60	146	38	42	99	8.79	519.82	25-17SA
G-4163	25	1 3/4	74	178	45	50	126	14.99	839.87	25-25SA
G-4163	35	2	83	197	50	57	138	20.65	1037.21	25-35SA
G-4163	42.5	2 1/4	95	222	57	65	160	28.3	1721.53	25-42.5SA
G-4163	55	2 1/2	105	260	65	70	180	41.05	2161.07	25-55SA
G-4163	85	3	127	330	75	83	190	62.24	3189.45	25-85SA

SEE WARNING AND APPLICATION INFORMATION AT END OF SHACKLE SECTION



- Made in Holland
- All shackles can be supplied with 3.1-B certificates
- Van Beest is certified by DNV to DNV 2.7-1
- Van Beest mill in Holland is approved to DNV, ABS, Lloyd's & Germanischer Lloyd

SHACKLE - SUPER BOW, ANCHOR, WITH BOLT AND NUT GREEN PIN®

- Material: High Strength Alloy Steel, Grade 8, quenched and tempered
- Standard: RR-C-271F, EN 13889
- Finish: Bow: Galvanized, Bolt: Painted Green
- Design Factor: 5:1
- Identification: Trademark, Size/WLL, Batch Code
- Temperature Range: -20°C up to +200°C
- Rated in Metric Ton(s)

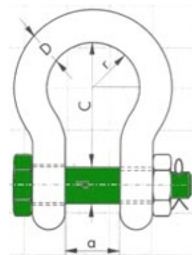

Item	WLL (t)	Trade Size (in)	a (mm)	C (mm)	D (mm)	d (mm)	2r (mm)	Wt./ea. (kg)	Price / ea.	Part Number
G-5263	30	1-1/2	60	146	38	42	99	8.79	1133.00	25-30SUPERSA
G-5263	40	1-3/4	74	178	45	50	126	15	1785.83	25-40SUPERSA
G-5263	55	2	83	197	57	57	138	22	2565.68	25-55SUPERSA
G-5263	85	2-1/2	105	260	70	70	180	42	3957.89	25-85SUPERSA
G-5263	120	3	127	329	83	83	190	70	6101.79	25-120SUPERSA
G-5263	150	3-3/4	147	400	95	95	238	112	12484.71	25-150SUPERSA

SEE WARNING AND APPLICATION INFORMATION AT END OF SHACKLE SECTION



- Made in Holland
- All shackles can be supplied with 3.1-B certificates
- Van Beest is certified by DNV to DNV 2.7-1
- Van Beest mill in Holland is approved to DNV, ABS, Lloyd's & Germanischer Lloyd

SHACKLE - WIDE MOUTH BOW, WITH BOLT AND NUT GREEN PIN®

- Material: High Strength Alloy Steel, Grade 8, quenched and tempered
- Standard: RR-C-271F, EN 13889
- Finish: Bow: Galvanized, Bolt: Painted Green
- Design Factor: 6:1
- Identification: Trademark, Size/WLL, Batch Code
- Temperature Range: -20°C up to +200°C
- Rated in Metric Ton(s)

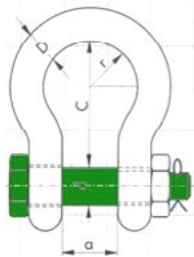

Item	WLL (t) (towing)	Size (in)	a (mm)	C (mm)	D (mm)	d - pin (mm)	2r (mm)	Wt./ea. (kg)	Price / ea.	Part Number
G-4463	22	1-1/2	106	216	38	42	159	12.5	1242.05	25-22WMTS
G-4463	30	1-3/4	127	248	45	50	175	18	1718.77	25-30WMTS

Van Beest Wide Mouth **Towing** Shackle to be used with correct loading across pin

Item	WLL (t) (lifting)	Size (in)	a (mm)	C (mm)	D (mm)	d - pin (mm)	2r (mm)	Wt./ea. (kg)	Price / ea.	Part Number
G-4263	16	1-1/2	106	216	38	42	159	12.5	1242.05	25-16WMS
G-4263	25	1-3/4	127	248	45	50	175	18	1718.77	25-25WMS
G-4263	30	2	146	273	50	57	207	25	2571.25	25-30WMS

Van Beest Wide Mouth **Lifting** Shackle to be used with correct loading across pin

SEE WARNING AND APPLICATION INFORMATION AT END OF SHACKLE SECTION



- Made in Holland
- All shackles can be supplied with 3.1-B certificates
- Van Beest is certified by DNV to DNV 2.7-1
- Van Beest mill in Holland is approved to DNV, ABS, Lloyd's & Germanischer Lloyd

SHACKLE - ROV SPRING RELEASE BOW, POLAR, WITH GREEN PIN®

- Material: Alloy Steel, Grade 8, Polar, quenched and tempered
- Standard: RR-C-271F, EN 13889
- Finish: Bow: Painted White, Bolt: Painted Green
- Design Factor: 5:1
- Identification: Trademark, Size/WLL, Batch Code
- Temperature Range: -40°C up to +200°C
- Rated in Metric Ton(s)
- Note: For in-line use only! This shackle is assembled with rope slings and monkey's fist for size starting from WLL 42.5 up to and including 150T a special mounting tool (tensioner) is required to assemble the shackle.

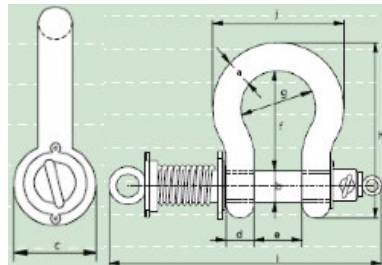

Item	WLL (t)	Dimensions (mm)										Wt./ea. (kg)
		a	b	c	d	e	f	g	h	i	j	
P-5367	12	32	35	72	32	51	115	83	201	262	147	6
P-5367	13.5	35	38	80	35	57	133	92	227	275	162	7
P-5367	17	38	42	88	38	60	146	99	249	330	175	14
P-5367	25	45	50	103	45	74	178	126	300	352	216	16
P-5367	35	50	57	116	50	83	197	138	334	373	238	21
P-5367	42.5	57	65	130	57	95	222	160	377	442	274	32
P-5367	55	65	70	145	65	105	260	180	433	470	310	43
P-5367	85	75	83	162	73	127	329	190	527	579	340	71
P-5367	120	95	95	208	91	147	399	238	646	674	428	131
P-5367	150	105	108	238	102	169	410	275	688	699	485	171



- Made in Holland
- All shackles can be supplied with 3.1-B certificates
- Van Beest is certified by DNV to DNV 2.7-1
- Van Beest mill in Holland is approved to DNV, ABS, Lloyd's & Germanischer Lloyd

SHACKLE - ROV LOCKING CLAMP RELEASE BOW, POLAR, WITH GREEN PIN®

- Material: Alloy Steel, Grade 8, Polar, quenched and tempered
- Standard: RR-C-271F, EN 13889
- Finish: Bow: Painted White, Bolt: Painted Green
- Design Factor: 6:1
- Identification: Trademark, Size/WLL, Batch Code
- Temperature Range: -60°C up to +200°C
- Rated in Metric Ton(s)
- Note: It is up to the user to attach the locking clamp with wire ropes etc. and attaching loops or monkey's fists. Van Beest supplies the shackle body, the shackle pin and locking clamp with spring pin.

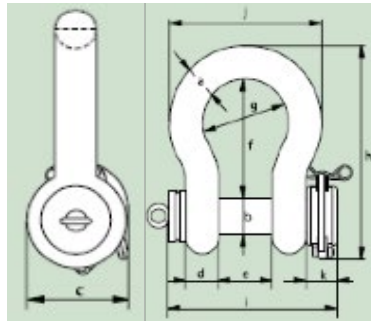

Item	WLL (t)	Dimensions (mm)											Wt./ea. (kg)
		a	b	c	d	e	f	g	h	i	j	k	
P-5365	17	38	42	88	38	60	146	99	250	217	175	48	8.19
P-5365	25	45	50	103	45	74	178	126	300	250	216	48	14.22
P-5365	55	65	70	145	65	105	260	180	433	330	310	48	39.59
P-5365	85	75	83	162	73	127	329	190	527	380	340	48	62



⚠ SHACKLE - WARNINGS AND APPLICATIONS

Side and symmetrical loading data applies to screw pin and bolt nut cotter shackles only!

Side and symmetrical loading not permitted on round pin shackles.

Angles of Side Load

0° - In-Line - 100 % of rated WLL (Working Load Limit)

45° - From In-Line - 70% of rated WLL

90° - From In-Line - 50% of rated WLL

Symmetrical Loading

Shackles symmetrically loaded with two legs at a maximum angle of 120° can be used to full Working Load Limit.

- For permanent or long term installation always use nut and cotter.
- Shackle must be large enough to avoid pinching or bunching of synthetic slings.
- Diameter of shackle must be greater than wire rope diameter if no thimble in eye.
- Mouse screw pin when used in long term or high vibration applications.

Shackles should be inspected before use to ensure that:

- All markings are legible.
- The body and pin are both identifiable as being of the same size, type and make.
- The threads of the pin and the body are undamaged.
- Never use a safety bolt type shackle without using the cotter pin.
- The body and the pin are not distorted or worn.

- The body and pin are free from nicks, gouges, cracks and corrosion
- Shackles may not be heat treated as this may affect their Working Load Limit.
- Never modify, repair or reshape a shackle by welding, heating or bending as this will affect the Working Load Limit.

Assembly

Ensure that the pin is correctly screwed into the shackle eye, i.e. tighten hand tight, and then secure using a wrench or other suitable tool so that the collar of the pin is fully seated on the shackle eye. Ensure that the pin is of the correct length so that it penetrates the full depth of the screwed eye and allows the collar of the pin to seat on the surface of the shackle eye.

Incorrect seating of the pin may be due to a bent pin, too tight fitting thread or misalignment of the pin holes. Do not use the shackle under these circumstances. Never replace a shackle pin except with one of the same size, type and make as it may not be suitable for the loads imposed.

Select the correct type of shackle and its Working Load Limit for the particular application. Should extreme circumstances or shock loading be applicable, this must be taken into account on selecting the correct shackle. Please note that commercial shackles are not to be used for lifting applications.

Make sure that the shackle is supporting the load correctly, i.e. along the axis of the shackle body centerline, avoid introduction of bending loads, unstable loads and do not overload.

Angle loads must be applied in the plane of the bow.

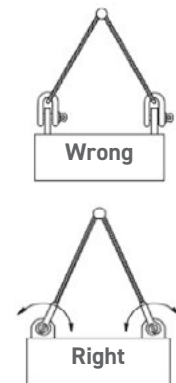
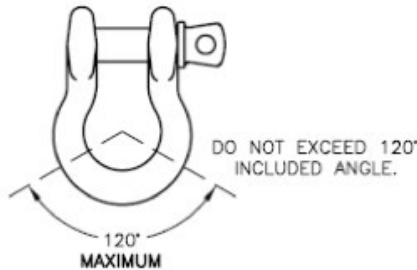
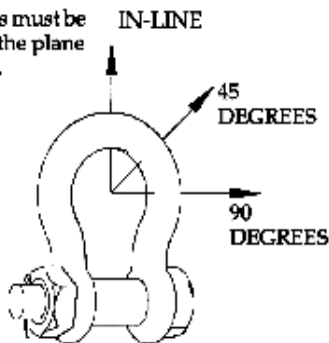

IMPROPER USE OR CARE OF SHACKLES CAN RESULT IN BODILY INJURY OR PROPERTY DAMAGE!

- TO AVOID INJURY OR PROPERTY DAMAGE;
- DO NOT EXCEED THE WLL (WORKING LOAD LIMIT)
- DO NOT SHOCK LOAD
- DO NOT SIDE LOAD - CENTRE LINE OF THE LOAD MUST COINCIDE WITH CENTRE LINE OF SHACKLE
- DO NOT REPLACE PIN OR BOLT WITH OTHER THAN ORIGINAL EQUIPMENT
- INSPECT BEFORE USE FOR WEAR, DEFORMATION, AND PIN ENGAGEMENT
- INSPECT SHACKLES BEFORE EACH USE AS OUTLINES IN ASME B30.26

TURNBUCKLE - JAW & JAW, GALVANIZED

®Trademark - Yellow Attached End Fitting Turnbuckle Design - Registration - ®TMA 796,844

Manufacturing/Design Information:

- Manufactured to: Federal Specification FF-T791B, ASTM F1145, Type 1, Form 1 - Class 7 (G)
- Meet and/or exceeds: ASME B30.26
- Safety/Design Factor: 5:1
- Forged - Quenched and Tempered (Ends), Normalizing (Body)

Coating / Protection:

- Hot dip galvanized & yellow powder coated

Identification / Marking:

- Name or trademark of manufacturer "OCEAN / OC"
- Size or rated load
- "Yellow" for instant recognition
- Additional Identification:
Production Code - Traceable to certificate & material



- Ends: Sizes 1/4" through 1/2" c/w nut & bolt
- Sizes 5/8" through 2-3/4" c/w pin & cotter
- Body/Thread: All sizes provided with Lock Nuts

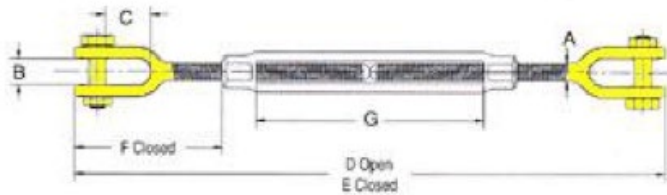

Thread Dia & Take Up (in x in)	WLL (lb)	Wt./ea. (lb)	Dimensions (in)							Pin Dia.	Price / ea.	Part Number
			A	B	C	D Open	E Closed	F Closed	G			
1/4 x 4	500	0.36	0.25	0.41	0.62	11.90	7.90	1.58	4.00	0.24	10.91	6-1/4X4JJ
5/16 x 4 1/2	800	0.52	0.31	0.47	0.87	13.90	9.40	1.98	4.50	0.24	12.35	6-5/16X4 1/2JJ
3/8 x 6	1200	0.81	0.38	0.50	0.87	17.38	11.38	2.12	6.00	0.31	15.74	6-3/8X6JJ
1/2 x 6	2200	1.50	0.50	0.63	1.06	19.00	13.00	2.75	6.00	0.39	23.21	6-1/2X6JJ
1/2 x 9	2200	1.74	0.50	0.63	1.06	25.00	16.00	2.75	9.00	0.39	26.76	6-1/2X9JJ
1/2 x 12	2200	2.40	0.50	0.63	1.06	31.00	19.00	2.75	12.00	0.39	38.05	6-1/2X12JJ
5/8 x 6	3500	2.72	0.63	0.75	1.31	20.88	14.88	3.50	6.00	0.5	38.55	6-5/8X6JJ
5/8 x 9	3500	3.24	0.63	0.75	1.31	26.88	17.88	3.50	9.00	0.5	45.21	6-5/8X9JJ
5/8 x 12	3500	3.74	0.63	0.75	1.31	32.88	20.88	3.50	12.00	0.5	51.81	6-5/8X12JJ
3/4 x 6	5200	4.11	0.75	0.94	1.50	22.60	16.60	4.18	6.00	0.62	53.28	6-3/4X6JJ
3/4 x 9	5200	5.10	0.75	0.94	1.50	28.60	19.60	4.18	9.00	0.62	56.60	6-3/4X9JJ
3/4 x 12	5200	6.65	0.75	0.94	1.50	34.60	22.60	4.18	12.00	0.62	74.30	6-3/4X12JJ
3/4 x 18	5200	7.00	0.75	0.94	1.50	46.60	28.60	4.18	18.00	0.62	92.73	6-3/4X18JJ
7/8 x 12	7200	8.17	0.88	1.13	1.75	36.32	24.32	4.85	12.00	0.75	112.34	6-7/8X12JJ
7/8 x 18	7200	10.78	0.88	1.13	1.75	48.32	30.32	4.85	18.00	0.75	120.64	6-7/8X18JJ
1 x 6	10 000	10.18	1.00	1.19	2.06	26.06	20.06	5.53	6.00	0.88	107.15	6-1X6JJ
1 x 12	10 000	12.00	1.00	1.19	2.06	38.06	26.06	5.53	12.00	0.88	156.36	6-1X12JJ
1 x 18	10 000	14.00	1.00	1.19	2.06	50.06	32.06	5.53	18.00	0.88	191.58	6-1X18JJ
1 x 24	10 000	17.00	1.00	1.19	2.06	62.06	38.06	5.53	24.00	0.88	225.74	6-1X24JJ
1-1/4 x 12	15 200	20.59	1.25	1.75	2.81	42.54	29.54	7.21	12.00	1.1	285.22	6-1-1/4X12JJ
1-1/4 x 18	15 200	24.25	1.25	1.75	2.81	53.54	35.54	7.21	18.00	1.1	322.08	6-1-1/4X18JJ
1-1/4 x 24	15 200	28.20	1.25	1.75	2.81	68.04	41.54	7.21	24.00	1.1	343.27	6-1-1/4X24JJ
1-1/2 x 12	21 400	32.6	1.50	2.06	2.81	45.68	33.68	8.93	12.00	1.38	428.85	6-1-1/2X12JJ
1 1/2 x 18	21 400	36.75	1.50	2.06	2.81	58.50	37.50	7.88	18.00	1.38	447.73	6-1-1/2X18JJ
1-1/2 x 24	21 400	41.60	1.50	2.06	2.81	70.50	43.50	7.88	24.00	1.38	553.16	6-1-1/2X24JJ
1-3/4 x 18	28 000	53.50	1.75	2.60	3.35	59.16	41.16	9.36	18.00	1.65	729.89	6-1-3/4X18JJ
1-3/4 x 24	28 000	63.36	1.75	2.60	3.35	71.18	47.18	9.36	24.00	1.65	827.72	6-1-3/4X24JJ
2 x 24	37 000	92.25	2.00	2.62	3.69	76.72	52.72	11.86	24.00	2	1412.70	6-2X24JJ
2-1/2 x 24	60 000	165.00	2.50	3.06	4.44	82.18	58.18	13.56	24.00	2.16	3490.22	6-2 1/2X24JJ
2-3/4 x 24	75 000	198.00	2.75	3.68	4.19	85.50	61.50	15.22	24.00	2.75	3924.90	6-2-3/4X24JJ

TURNBUCKLE - EYE & EYE, GALVANIZED

Conforms to Federal Specification FF-T-791B, ASTM F1145, Type 1, Form 1 - Class 4 (D)

°Trademark - Yellow Attached End Fitting Turnbuckle Design - Registration - °TMA 796,844

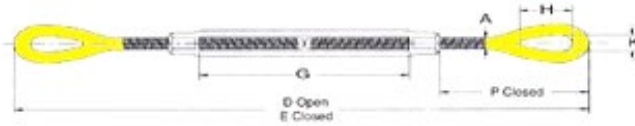
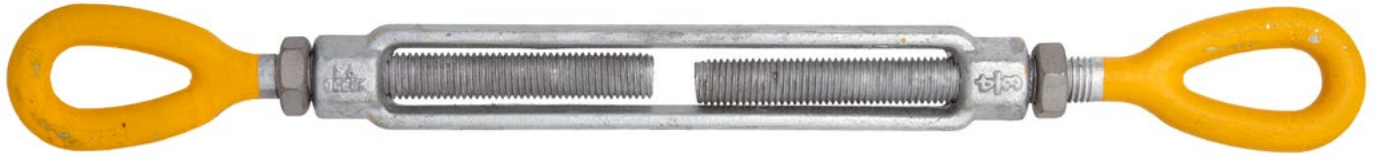

Thread Dia & Take Up (in x in)	WLL (lb)	Wt./ ea. (lb)	Dimensions (in)							Price / ea.	Part Number
			A	D Open	E Closed	G	H	K	P Closed		
5/16 x 4 1/2	800	0.47	0.31	14.12	9.62	4.50	0.94	0.44	2.09	10.78	6-5/16X41/2EE
3/8 x 6	1200	0.75	0.38	18.16	12.16	6.00	1.12	0.53	2.52	13.53	6-3/8X6EE
1/2 x 6	2200	1.60	0.50	19.96	13.96	6.00	1.44	0.72	3.23	21.09	6-1/2X6EE
1/2 x 9	2200	1.83	0.50	25.96	16.96	9.00	1.44	0.72	3.23	25.62	6-1/2X9EE
1/2 x 12	2200	2.14	0.50	32.08	19.08	12.00	1.44	0.72	3.23	33.84	6-1/2X12EE
5/8 x 6	3500	2.75	0.63	21.68	15.68	6.00	1.75	0.88	3.90	34.71	6-5/8X6EE
5/8 x 9	3500	3.13	0.63	27.68	18.68	9.00	1.75	0.88	3.90	40.25	6-5/8X9EE
5/8 X 12	3500	3.42	0.63	34.93	21.68	12.00	1.75	0.88	3.90	44.92	6-5/8X12EE
3/4 x 9	5200	4.61	0.75	29.62	20.62	9.00	2.09	1.00	4.69	51.58	6-3/4X9EE
3/4 x 12	5200	5.43	0.75	35.62	23.62	12.00	2.09	1.00	4.69	63.26	6-3/4X12EE
3/4 x 18	5200	7.83	0.75	47.64	29.64	18.00	2.09	1.00	5.09	82.48	6-3/4X18EE
7/8 x 12	7200	8.10	0.88	36.82	24.82	12.00	2.38	1.25	5.10	77.51	6-7/8X12EE
1 x 12	10 000	11.93	1.00	39.97	27.72	12.00	3.00	1.44	6.36	90.43	6-1X12EE

TURNBUCKLE - HOOK & HOOK, GALVANIZED

Conforms to Federal Specification FF-T-791B, ASTM F1145, Type 1, Form 1 - Class 5 (E)

°Trademark - Yellow Attached End Fitting Turnbuckle Design - Registration - °TMA 796,844

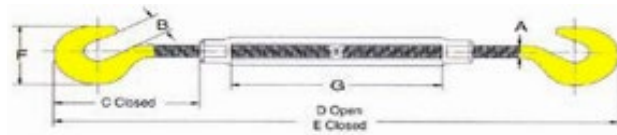
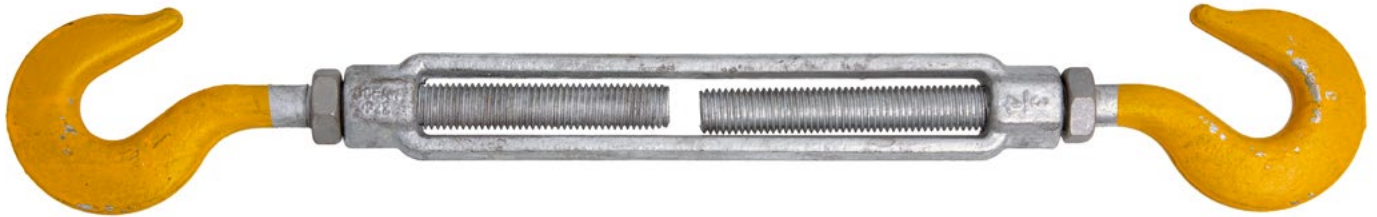

Thread Dia & Take Up (in x in)	WLL (lb)	Wt./ea. (lb)	Dimensions (in)							Price / ea.	Part Number
			A	B	C Closed	D Open	E Closed	F	G		
5/16 x 4 1/2	700	0.47	0.31	0.50	1.94	13.81	9.31	1.50	4.50	10.78	6-5/16X41/2HH
3/8 x 6	1000	0.75	0.38	0.56	2.30	17.72	11.72	1.77	6.00	13.53	6-3/8X6HH
1/2 x 6	1500	1.60	0.50	0.66	2.94	19.38	13.38	2.28	6.00	21.09	6-1/2X6HH
1/2 x 9	1500	1.83	0.50	0.66	2.94	25.38	16.38	2.28	9.00	25.62	6-1/2X9HH
5/8 x 6	2250	2.75	0.63	0.84	3.69	21.25	15.25	2.81	6.00	33.84	6-5/8X6HH
5/8 x 9	2250	3.13	0.63	0.84	3.69	27.25	18.25	2.81	9.00	40.25	6-5/8X9HH
3/4 x 9	3000	4.61	0.75	0.98	4.52	29.28	20.28	3.33	9.00	51.58	6-3/4X9HH
3/4 x 12	3000	5.43	0.75	0.98	4.52	35.28	23.28	3.33	12.00	63.26	6-3/4X12HH
7/8 x 12	4000	8.10	0.88	1.13	5.19	37.00	25.00	3.78	12.00	77.51	6-7/8X12HH
1 x 12	5000	11.93	1.00	1.25	5.84	38.69	26.69	4.25	12.00	90.43	6-1X12HH

TURNBUCKLE - JAW & EYE, GALVANIZED

Conforms to Federal Specification FF-T-791B, ASTM F1145, Type 1, Form 1 - Class 8 (H)

°Trademark - Yellow Attached End Fitting Turnbuckle Design - Registration - °TMA 796,844

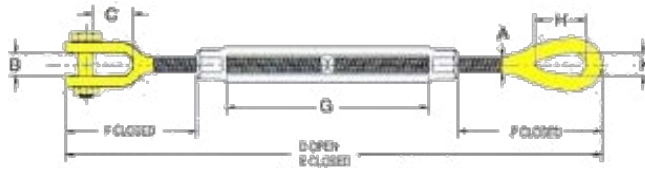
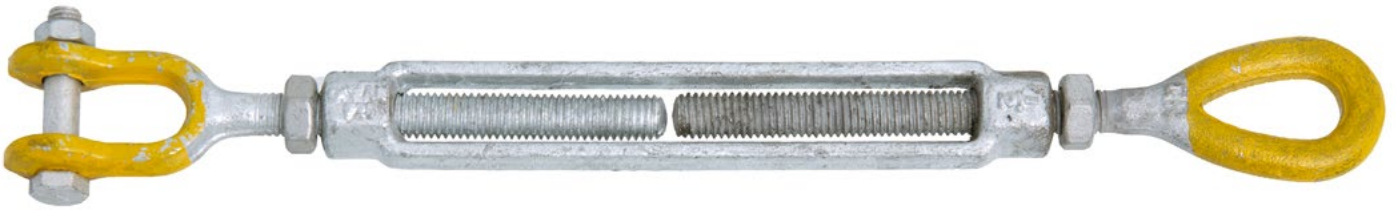

Thread Dia & Take Up (in x in)	WLL (lb)	Wt./ ea. (lb)	Dimensions (in)										Price / ea.	Part Number
			A	B	C	D Open	E Closed	F Closed	G	H	K	P Closed		
3/8 x 6	1200	0.76	0.38	0.50	0.87	17.77	11.77	2.12	6.00	1.12	0.53	2.52	14.91	6-3/8X6JE
1/2 x 6	2200	1.53	0.50	0.63	1.06	19.48	13.48	2.75	6.00	1.44	0.72	3.23	22.30	6-1/2X6JE
1 1/2 x 24	21 400	41.60	1.50	2.06	2.81	70.50	43.50	7.88	24.00	4.09	2.12	8.62	772.38	6-1-1/2X24JE
1 3/4 x 24	28 000	63.36	1.75	2.60	3.35	71.18	47.18	9.36	24.00	4.65	2.38	9.03	1254.32	6-1-3/4X24JE

TURNBUCKLE - BOTTLE TYPE (CLOSED) GALVANIZED



Break Load (lb)	Thread Dia. & Take Up (in x in)	Price / ea.	Part Number
4500	3/8 x 6	32.84	6-3/8"BT
6200	1/2 x 9	47.28	6-1/2"BT
9700	5/8 x 9	91.84	6-5/8"BT
13 500	3/4 x 9	145.28	6-3/4"BT
19 200	7/8 x 12	184.74	6-7/8"BT
24 800	1 x 13	252.17	6-1"BT
45 000	1 1/4 x 15	462.32	6-1-1/4"BT

- Material: Steel
- Finish: Galvanized

TURNBUCKLE - JAW & JAW, BOTTLE TYPE (CLOSED) STAINLESS STEEL

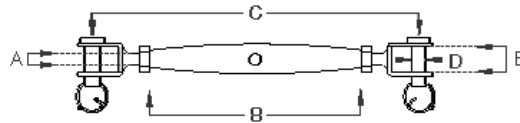

A Size (in)	Thread Dia. & Take Up (in)				WLL (lb)	Wt./ea. (lb)	Price / ea.	Part Number
	B	C	D	E				
1/4	3.72	5.64	0.20	0.25	440	0.20	31.38	6-1/4"BTSS
5/16	4.20	6.50	0.31	0.37	840	0.35	55.91	6-5/16"BTSS
3/8	4.87	7.75	0.37	0.43	1260	0.55	77.62	6-3/8"BTSS
1/2	5.75	9.50	0.50	0.50	2000	1.50	112.07	6-1/2"BTSS
5/8	7.50	13.00	0.62	0.68	3500	2.30	215.05	6-5/8"BTSS
3/4	11.00	16.75	0.75	0.88	5000	5.80	366.64	6-3/4"BTSS

- Material: 316 Stainless Steel
- Finish: Stainless Steel

TURNBUCKLE - JAW & JAW, STAINLESS STEEL

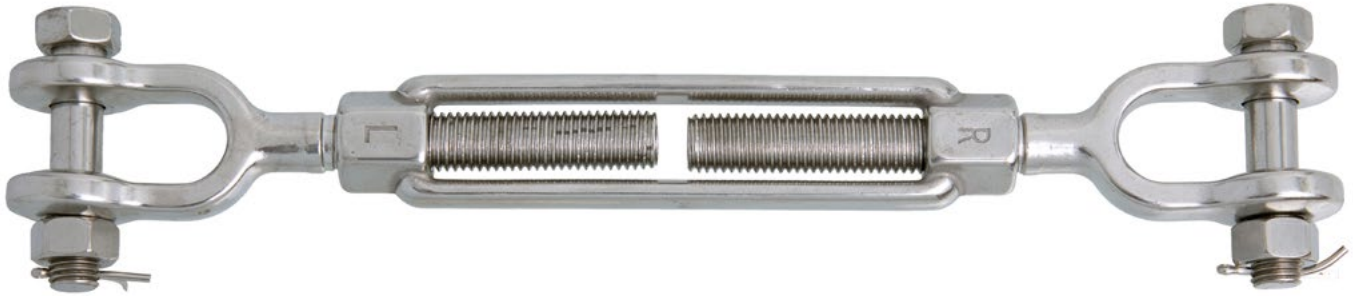

WLL (lb)	Thread Dia. & Take Up (in x in)	Price / ea.	Part Number
460	1/4 x 4	26.50	6-1/4X4SSJJ
780	5/16 x 4 1/2	44.92	6-5/16X4.5SSJ
1160	3/8 x 6	67.96	6-3/8X6SSJJ
2150	1/2 x 6	78.87	6-1/2X6SSJJ
3500	5/8 x 6	173.91	6-5/8X6SSJJ
5140	3/4 x 6	259.98	6-3/4X6SSJJ

- Material: 304 Stainless Steel
- Finish: Stainless Steel
- Design Factor: 4:1

TURNBUCKLE - EYE & EYE, LASHING



WLL (lb)	Thread Dia. & Take Up (in x in)	Price / ea.	Part Number
3620	3/4 x 18	45.56	6-3/4X18BLEE

- Material: Steel
- Finish: Self-Coloured, Black
- Design Factor: 6:1

TURNBUCKLE - STUB END

Conforms to Federal Specification FFT-T-791B, Type 1, Form 1 Class 3

- Standard: FF-T-791B
- Finish: Self-Coloured
- Design Factor: 5:1

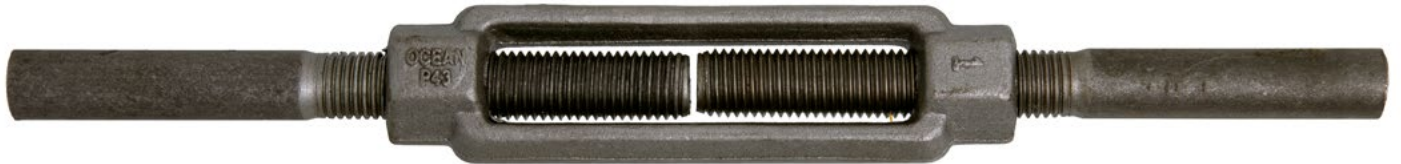
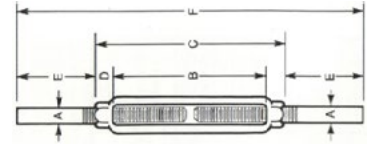

Thread Dia. & Take Up (in x in)	WLL (lb)	Wt./ea. (lb)	Dimensions (in)						Price / ea.	Part Number
			A	B	C	D	E	F		
1/2 x 6	2200	1.25	0.50	6.00	7.50	0.75	4.25	16.00	16.84	6-1/2X6SET
5/8 x 6	3500	2.11	0.63	6.00	7.88	0.94	4.06	16.00	32.30	6-5/8X6SET
3/4 x 6	5200	3.27	0.75	6.00	8.25	1.13	4.38	17.00	37.23	6-3/4X6SET
7/8 x 6	7200	4.78	0.88	6.00	8.63	1.31	4.69	18.00	58.68	6-7/8X6SET
1 x 6	10 000	6.36	1.00	6.00	9.00	1.50	5.00	19.00	75.34	6-1X6SET
1 1/4 x 6	15 200	10.18	1.25	6.00	9.13	1.56	5.44	20.00	115.48	6-1-1/4X6SET
1 1/2 x 12	21 400	20.44	1.50	12.00	15.75	1.88	5.38	26.50	173.08	6-1-1/2X12SET

TURNBUCKLE - STUB END, BODY ONLY

Conforms to Federal Specification FFT-T-791B, Type 1, Form 1 Class 3

WLL (lb)	Size (in x in)	Price / ea.	Part Number
1200	3/8 x 6	10.96	6-3/8X6TBSC
2200	1/2 x 6	12.36	6-1/2X6TBSC
3500	5/8 x 6	16.40	6-5/8X6TBSC
5200	3/4 x 6	24.21	6-3/4X6TBSC
7200	7/8 x 6	56.29	6-7/8X6TBSC
10 000	1 x 6	62.47	6-1X6TBSC
15 200	1 1/4 x 6	74.77	6-11/4X6TBSC
21 400	1 1/2 x 6	173.08	6-11/2X6TBSC



- Standard: FF-T-791B
- Finish: Self-Coloured
- Design Factor: 5:1

TURNBUCKLE - HEAVY DUTY, GN®



- Material: High tensile steel
- Finish: Painted
- Design Factor: 5:1
- Temperature Range: -20°C up to +200°C
- Certification: Certificate of Conformity (on request)
- Rated in Metric Ton(s)
- Non-standard sizes or custom product available on request

WLL (ton)	Jaw-Jaw		Eye-Eye		Jaw-Eye		Thread	Price	Part Number
	Dimensions (mm)		Dimensions (mm)		Dimensions (mm)				
	L in	L out	L in	L out	L in	L out			
13.5	935	1260	840	1165	890	1215	Tr 55x8	Pricing on Request	116-TB13.5
17	1010	1360	920	1270	965	1315	Tr 65x8		116-TB17
25	1085	1415	975	1305	1030	1360	Tr 70x8		116-TB25
30	1160	1530	1020	1390	1090	1460	Tr 75x8		116-TB30
35	1250	1650	1100	1500	1175	1575	Tr 80x8		116-TB35
45	1300	1780	1170	1650	1235	1715	Tr 90x8		116-TB45
55	1380	1890	1270	1780	1325	1835	Tr 100x8		116-TB55
70	1480	2025	1390	1940	1435	1985	Tr 110x8		116-TB70
85	1565	2200	1515	2150	1540	2175	Tr 120x8		116-TB85
100	1630	2360	1600	2330	1615	2345	Tr 130x8		116-TB100
120	1745	2340	1735	2330	1740	2335	Tr 140x8		116-TB120
160	1870	2470	1860	2460	1865	2465	Tr 160x8		116-TB160
200	2020	2640	2000	2620	2010	2630	Tr 180x8		116-TB200
250	2170	2840	2210	2880	2190	2860	Tr 200x8		116-TB250

Tolerance: Forged parts ± 5%, machined parts ± 1 mm

TURNBUCKLE - HEAVY DUTY, GN® (CONTINUED)

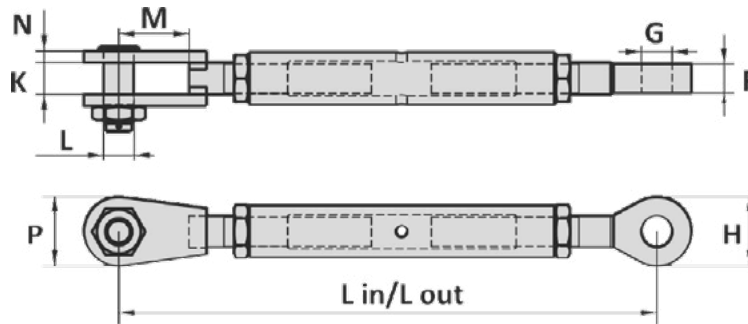

WLL (ton)	Dimensions (mm)								Wt. J-J (kg)	Wt. E-E (kg)	Wt. J-E (kg)
	K	N	M	L	P	F	H	G			
13.5	55	20	122	51	120	50	120	53	45	36	41
17	65	28	130	63	140	55	140	65	72	55	62
25	76	30	145	70	140	70	140	72	83	60	73
30	80	35	160	72	150	70	150	74	100	68	85
35	90	40	175	80	170	80	170	82	140	96	117
45	100	45	175	90	190	90	190	93	177	117	146
55	110	50	175	100	210	100	210	103	232	156	194
70	110	55	175	108	230	100	230	111	293	200	245
85	130	75	175	127	270	125	270	130	441	270	363
100	140	90	175	140	290	125	290	143	607	364	485
120	155	90	190	152	340	140	340	155	740	490	615
160	170	100	210	178	380	160	380	181	967	614	791
200	190	110	250	190	400	170	400	193	1380	720	1050
250	210	120	280	250	520	190	520	253	1825	832	1345

EYE BOLT - REGULAR WITH NUT

- Material: Forged carbon steel quenched & tempered
- Standard: EN 4278, ASME B30.26
- Finish: Hot dip galvanized
- Design Factor: 5:1
- Identification: Size/Ocean



Dia. & Length (in)	WLL (lb)	Weight / 100 pcs. (lb)	Dimensions (in)					Price / ea.	Part Number
			A	C	B	D	E		
3/8 x 2 1/2	1550	23.30	0.38	1.50	2.50	0.75	1.50	5.95	6-3/8X21/2EBG
3/8 x 4 1/2	1550	29.50	0.38	2.50	4.50	0.75	1.50	6.24	6-3/8X41/2EBG
3/8 x 6	1550	35.20	0.38	2.50	6.00	0.75	1.50	6.74	6-3/8X6EBG
1/2 x 3 1/4	2600	50.30	0.50	1.50	3.25	1.00	2.00	9.08	6-1/2X31/4EBG
1/2 x 6	2600	66.10	0.50	3.00	6.00	1.00	2.00	10.03	6-1/2X6EBG
1/2 x 8	2600	82.00	0.50	3.00	8.00	1.00	2.00	12.00	6-1/2X8EBG
1/2 x 10	2600	88.00	0.50	3.00	10.00	1.00	2.00	13.57	6-1/2X10EBG
5/8 x 4	5200	103.10	0.62	2.00	4.00	1.25	2.50	13.19	6-5/8X4EBG
5/8 x 6	5200	118.20	0.62	3.00	6.00	1.25	2.50	15.56	6-5/8X6EBG
5/8 x 8	5200	135.10	0.62	3.00	8.00	1.25	2.50	17.00	6-5/8X8EBG
5/8 x 10	5200	153.60	0.62	3.00	10.00	1.25	2.50	20.50	6-5/8X10EBG
5/8 x 12	5200	167.10	0.62	4.00	12.00	1.25	2.50	22.65	6-5/8X12EBG
3/4 x 4 1/2	7200	168.60	0.75	2.00	4.25	1.50	3.00	22.56	6-3/4X41/2EBG
3/4 x 6	7200	184.50	0.75	3.00	6.00	1.50	3.00	24.10	6-3/4X6EBG
3/4 x 8	7200	207.90	0.75	3.00	8.00	1.50	3.00	25.15	6-3/4X8EBG
3/4 x 10	7200	235.00	0.75	3.00	10.00	1.50	3.00	30.56	6-3/4X10EBG
3/4 x 12	7200	257.50	0.75	4.00	12.00	1.50	3.00	32.10	6-3/4X12EBG
1 x 12	13 300	540.00	1.00	4.00	12.00	2.00	4.00	66.23	6-1X12EBG

SEE WARNING AND APPLICATION INFORMATION FOR EYE BOLTS.

EYE BOLT - SCREW

Size (in)	Thread Length (in)	Eye I.D (in)	Price / ea.	Part Number
1/4 x 2	1.50	0.47	4.28	6-1/4X2SC
5/16 x 2 1/4	1.70	0.60	5.12	6-5/16X21/4SC
3/8 x 2 1/2	1.90	0.72	6.26	6-3/8X21/2SC
1/2 x 3 1/4	2.45	0.98	10.06	6-1/2X31/4SC
5/8 x 4	3.00	1.17	13.38	6-5/8X4SC



- **Non Load Rated**
- **For use in wood**
- Material: Forged
- Standard: EN 4278, ASME B30.26
- Finish: Hot dip galvanized
- Identification: Size

EYE BOLT - SHOULDER WITH NUT, UNC

Size (in)	Shank Length (in)	Thread Length (in)	Price / ea.	Part Number
1 1/2	3 1/2	2	172.57	6-11/2x31/2GS



- Material: Forged carbon steel quenched & tempered
- Standard: EN 4278
- Finish: Hot dip galvanized
- Identification: Size

SEE WARNING AND APPLICATION INFORMATION FOR EYE BOLTS.

EYE BOLT - SHOULDER WITH NUT

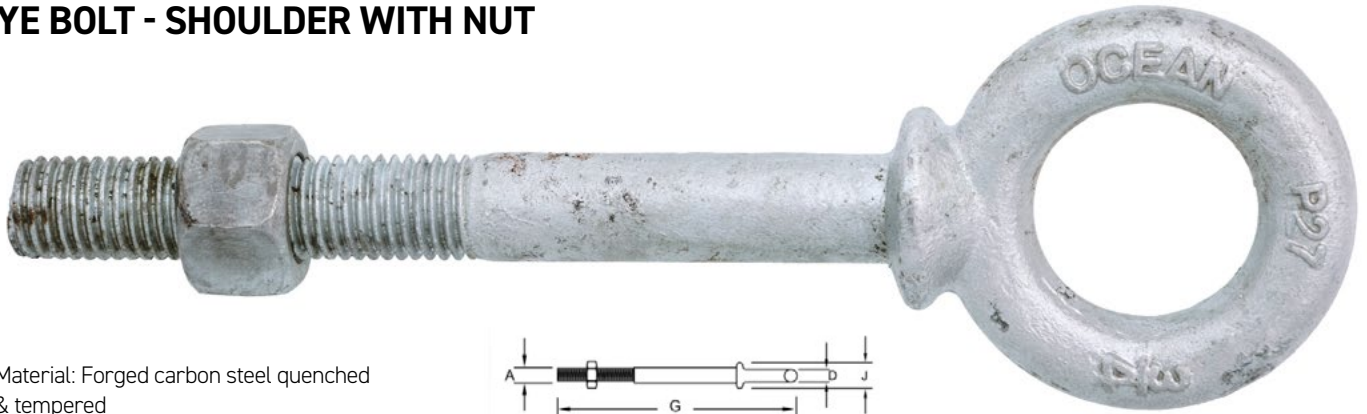

- Material: Forged carbon steel quenched & tempered
- Standard: EN 4278
- Finish: Hot dip galvanized
- Design Factor: 5:1
- Identification: Size/Ocean

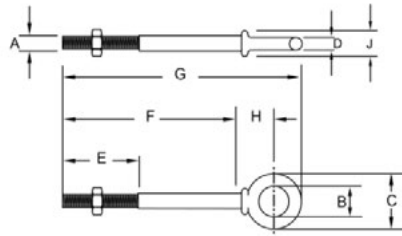

Size (in)	WLL (lb)	Weight / 100 pcs. (lb)	Dimensions (in)									Price / ea.	Part Number
			A	B	C	D	E	F	G	H	J		
1/4 x 2	650	6.6	0.25	0.50	0.88	0.19	1.50	2.00	2.94	0.50	0.47	3.51	6-1/4X2GS
1/4 x 4	650	9.1	0.25	0.50	0.88	0.19	2.50	4.00	4.94	0.50	0.47	4.63	6-1/4X4GS
5/16 x 2 1/4	1200	12.5	0.31	0.62	1.12	0.25	1.50	2.25	3.50	0.69	0.56	4.63	6-5/16X21/4GS
5/16 x 4 1/4	1200	18.8	0.31	0.62	1.12	0.25	2.50	4.25	5.50	0.69	0.56	5.70	6-5/16X41/4GS
3/8 x 2 1/2	1550	21.4	0.38	0.75	1.38	0.31	1.50	2.50	3.97	0.78	0.66	5.69	6-3/8X21/2GS
3/8 x 4 1/2	1550	25.3	0.38	0.75	1.38	0.31	2.50	4.50	5.97	0.78	0.66	6.56	6-3/8X41/2GS
1/2 x 3 1/4	2600	42.6	0.50	1.00	1.75	0.38	1.50	3.25	5.12	1.00	0.91	8.58	6-1/2X31/4GS
1/2 x 6	2600	56.8	0.50	1.00	1.75	0.38	3.00	6.00	7.88	1.00	0.91	9.82	6-1/2X6GS
5/8 x 4	5200	68.6	0.62	1.25	2.25	0.50	2.00	4.00	6.44	1.31	1.12	11.99	6-5/8X4GS
5/8 x 6	5200	102.4	0.62	1.25	2.25	0.50	3.00	6.00	8.44	1.31	1.12	13.82	6-5/8X6GS
3/4 x 4 1/2	7200	144.5	0.75	1.50	2.75	0.62	2.00	4.50	7.44	1.56	1.38	18.81	6-3/4X41/2GS
3/4 x 6	7200	167.5	0.75	1.50	2.75	0.62	3.00	6.00	8.94	1.56	1.38	19.29	6-3/4X6GS
7/8 x 5	10 600	225.0	0.88	1.75	3.25	0.75	2.50	5.00	8.46	1.84	1.56	31.68	6-7/8X5GS
1 x 6	13 300	366.3	1.00	2.00	3.75	0.88	3.00	6.00	9.97	2.09	1.81	45.68	6-1X6GS
1 x 9	13 300	422.5	1.00	2.00	3.75	0.88	4.00	9.00	12.97	2.09	1.81	59.12	6-1X9GS
1 1/4 x 8	21 000	650	1.25	2.50	4.50	1.00	4.00	8.00	12.72	2.47	2.28	87.54	6-11/4X8GS
1 1/4 x 12	21 000	795	1.25	2.50	4.50	1.00	4.00	12.00	16.72	2.47	2.28	111.69	6-11/4X12GS
1 1/2 x 15	24 000	1425	1.50	3.00	5.50	1.25	6.00	15.00	20.75	3.00	2.75	234.23	6-11/2X15GS

SEE WARNING AND APPLICATION INFORMATION FOR EYE BOLTS.

EYE BOLT - SHOULDER WITH NUT



WLL (lb)	Size (in)	Price / ea.	Part Number
500	1/4 x 2	17.91	6-1/4x2EBSS
500	1/4 x 4	22.60	6-1/4x4EBSS
798	5/16 x 2 1/4	27.95	6-516X214EBSS
798	5/16 x 4 1/4	33.58	6-516x414EBSS
1196	3/8 x 2 1/2	34.52	6-3/8X212EBSS
1196	3/8 x 4 1/4	43.86	6-3/8X414EBSS
2195	1/2 x 3 1/4	45.82	6-1/2X314EBSS
2195	1/2 x 6	50.67	6-1/2X6EBSS
3493	5/8 x 4	70.09	6-5/8X4EBSS
3493	5/8 x 6	81.99	6-5/8X6EBSS
5189	3/4 x 4 1/2	108.56	6-3/4X412EBSS
5189	3/4 x 6	130.43	6-3/4X6EBSS
7185	7/8 x 5	232.90	6-7/8X5EBSS
8675	1 x 6	441.06	6-1X6EBSS
8675	1 x 9	495.31	6-1X9EBSS

- Material: Forged 304 Stainless Steel
- Standard: EN 4278
- Finish: Stainless Steel
- Design Factor: 5:1
- Identification: Size

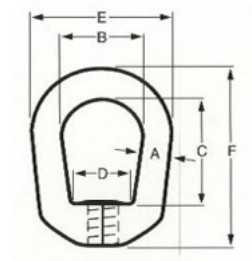

EYE NUT

Tap Size (in)	WLL (lb)	Dimensions (in)						Price / ea.	Part Number
		A	B	C	D	E	F		
1/2	2150	0.500	1.25	1.50	1.04	1.98	2.50	20.86	6-1/2SSEN

- Material/Finish: 304 Stainless Steel
- Standard: DIN 582
- Design Factor: 5:1
- Identification: Size/WLL

SEE WARNING AND APPLICATION INFORMATION FOR EYE BOLTS.

EYE BOLT - RING WITH SHOULDER & NUT

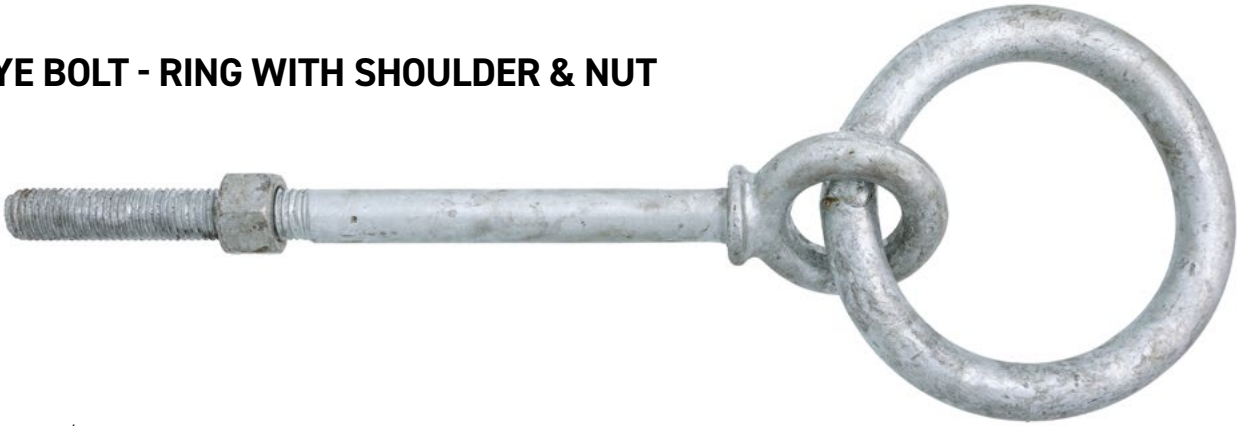

- Material/Finish: 304 Stainless Steel & Hot Dip Galvanized

Size (in)	Ring Stock (in)	ID of Ring (in)	Max. Load (lb)	Stainless Steel (304 grade)		Galvanized	
				Price / ea.	Part Number	Price / ea.	Part Number
3/8 x 4 1/2	3/8	2	600	39.57	6-3/8X412BRSS	15.74	6-3/8X41/2BGR
3/8 x 6	3/8	2	600	44.01	6-3/8X6BRSS	19.36	6-3/8X6BGR
1/2 x 6	1/2	2 1/2	1100	70.28	6-1/2X6BRSS	33.76	6-1/2X6BGR
1/2 x 8	1/2	2 1/2	1100	76.39	6-1/2X8BRSS	47.52	6-1/2X8BGR
3/4 x 10	3/4	3 3/4	2600	285.47	6-3/4X10BRSS	119.50	6-3/4X10BGR

EYE BOLT - SHOULDER MACHINE, IMPERIAL

- Material: Forged Steel
- Standard: EN 4278, ASME B30.26
- Finish: Self-Coloured
- Design Factor: 5:1
- Identification: Size/Ocean



WLL (lb)	Shank (in)		Eye (in)		Weight / 100 pcs. (lb)	Price / ea.	Part Number
	Dia.	Length	I.D.	O.D.			
650	1/4	1	0.75	1.13	4.9	3.40	6-1/4X1EB
1200	5/16	1-1/8	0.88	1.38	8.5	3.78	6-5/16X11/8EB
1550	3/8	1-1/4	1.00	1.62	14.0	4.73	6-3/8X11/4EB
2600	1/2	1-1/2	1.19	1.95	29.5	7.31	6-1/2X11/2EB
5200	5/8	1-3/4	1.38	2.38	58.0	10.85	6-5/8X13/4EB
7200	3/4	2	1.50	2.76	88.5	14.95	6-3/4X2EB
10 600	7/8	2-1/4	1.75	3.25	129.0	18.36	6-7/8X21/4EB
13 300	1	2-1/2	2.00	3.76	198.5	27.39	6-1X21/2EB
21 000	1-1/4	3	2.50	4.50	396.0	61.24	6-11/4X3EB
24 000	1-1/2	3-1/2	3.00	5.50	654.0	107.60	6-11/2X31/2EB

SEE WARNING AND APPLICATION INFORMATION FOR EYE BOLTS.

EYE BOLT - SHOULDER MACHINE, METRIC

- Material: Forged Steel
- Standard: EN 4278, ASME B30.26
- Finish: Self-Coloured
- Design Factor: 5:1
- Identification: Size/Ocean

WLL (kg)	Thread Size & Pitch	Shank (mm)		Eye I.D. (mm)	Weight / ea. (kg)	Price / ea.	Part Number
		Dia.	Length				
200	M6x1.0	6	25.5	18.43	0.03	10.69	6-6MEB
400	M8x1.25	8	31.75	15.51	0.05	12.11	6-8MEB
640	M10x1.5	10	31.75	24.76	0.07	14.73	6-10MEB
1000	M12x1.75	12	38	23.94	0.11	18.05	6-12MEB
1800	M16x2.0	16	44.5	29.5	0.25	27.93	6-16MEB
2500	M20x2.5	20	51	36.51	0.42	41.76	6-20MEB
4808	M22x2.5	22	57	43.69	0.58	62.70	6-22MEB
4000	M24x3.0	24	63.5	49.36	1.05	72.13	6-24MEB
9525	M32x3.0	32	76	61.58	1.80	179.94	6-32MEB

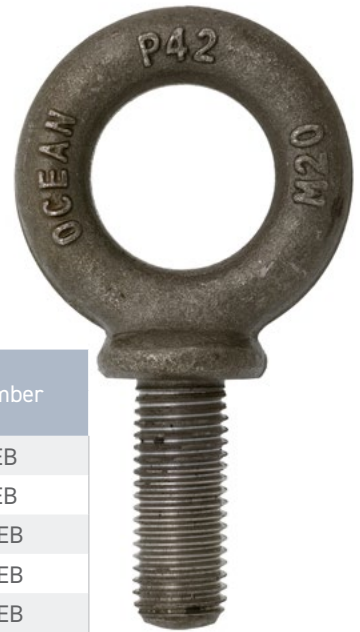

EYE PAD

Reference local welding specifications for proper welding procedures.

- Material: Steel
- Finish: Self colored
- Identification: Type

Size	I.D. Eye (in)	O.D. Eye (in)	Dia. of Shoulder (in)	Overall Height (in)	Wt./ 100 pcs (lb)	Price / ea.	Part Number
2	3/4	1 1/2	1 1/16	1 5/8	17.25	7.02	6-#2PESC
4	1	2 1/8	1 7/16	2 11/32	50.00	11.61	6-#4PESC
5	1 1/4	2 5/8	1 3/4	2 3/4	82.50	14.18	6-#5PESC



SEE WARNING AND APPLICATION INFORMATION FOR EYE BOLTS.

EYE NUT

Note: Order by tap size, marking on eye nut is body stock diameter

- Material: Forged
- Standard: EN 4278, ASME B30.26
- Finish: Galvanized
- Design Factor: 5:1
- Identification: Size ("A" Dia.)
- Thread oversized for galvanized threads

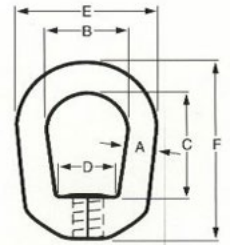

Std Tap Size (in)	Dimensions (in)						Wt. / ea. (lb)	WLL (lb)	Price / ea.	Part Number
	A	B	C	D	E	F				
1/4	1/4	3/4	1 1/16	21/32	1 1/4	1 11/16	0.09	520	3.65	6-1/4EN
5/16	1/4	3/4	1 1/16	21/32	1 1/4	1 11/16	0.09	850	3.65	6-5/16EN
3/8	5/16	1	1 1/4	3/4	1 5/8	2 1/16	0.18	1250	3.97	6-3/8EN
1/2	3/8	1 1/4	1 1/2	1	2	2 1/2	0.28	2250	6.55	6-1/2EN
5/8	1/2	1 1/2	2	1 3/16	2 1/2	3 3/16	0.58	3600	9.66	6-5/8EN
3/4	5/8	1 3/4	2 3/8	1 3/8	3	3 7/8	1.00	5200	16.77	6-3/4EN
7/8	3/4	2	2 5/8	1 5/8	3 1/2	4 5/16	1.70	7200	22.83	6-7/8EN
1	7/8	2 1/4	3 1/16	1 7/8	4	5	2.75	10 000	36.47	6-1EN
1 1/4	1	2 1/2	3 1/2	1 15/16	4 1/2	5 3/4	3.85	15 500	59.13	6-1-1/4EN



EYE BOLTS FORGED - WARNINGS AND APPLICATION INSTRUCTIONS

How should you select the right bolt?

- Eye Bolts are marked with their thread size NOT with their rated capacities. Make sure you select the correct eyebolt based on its type and capacity for the lift you are conducting.
- Use plain or regular eye bolts (non-shoulder) or ring bolts for vertical loading only.
- Angle loading on non-shoulder bolts will bend or break them.
- Use shoulder eye bolts for vertical or angle loading.

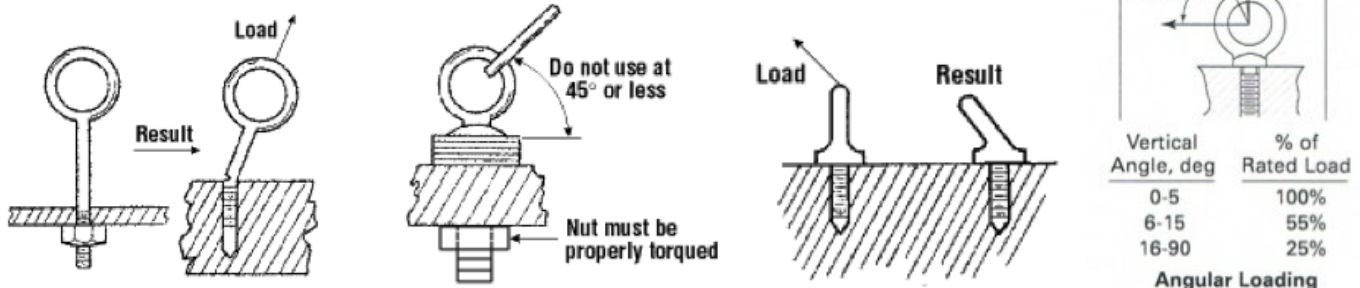

How should you use eye bolts safely?

- Orient the eye bolt in line with the slings. If the load is applied sideways, the eye bolt may bend.
- Pack washers between the shoulder and the load surface to ensure that the eye bolt firmly contacts the surface. Ensure that the nut is properly torqued.
- Engage at least 90% of threads in receiving a hole when using shims or washers.
- Attach only one sling leg to each eye bolt.
- Inspect and clean the eye bolt threads and the hole.
- Screw the eye bolt on all the way down and properly seat.
- Ensure the tapped hole for a screw eye bolt (body bolts) has a minimum depth of one-and-a-half times the bolt diameter.
- Install the shoulder at right angles to the axis of the hole. The shoulder should be in full contact with the surface of the object being lifted.
- Use a spreader bar with regular (non-shoulder) eye bolts to keep the lift angle at 90° to the horizontal.
- Use eye bolts at a horizontal angle greater than 45°. Sling strength at 45° is 71% of vertical sling capacity. Eye bolt strength at 45° horizontal angle drops down to 25% of vertical lifting capacity.
- Use a swivel hoist ring for angled lifts. The swivel hoist ring will adjust to any sling angle by rotating around the bolt and the hoisting eye pivots 180°.

What should you avoid when using eye bolts?

- Do not run a sling through a pair of eye bolts: this will reduce the effective angle of lift and will put more strain on the rigging.
- Do not force the slings through eye bolts. This force may alter the load and the angle of loading.
- Do not use eye bolts that have been ground, machined or stamped.
- Do not use bars, grips or wrenches to tighten eye bolts.
- Do not paint an eye bolt. The paint could cover up flaws.
- Do not force hooks or other fittings into the eye; they must fit freely.
- Do not shock load eye bolts.
- Do not use a single eye bolt to lift a load that is free to rotate.
- Do not use eye bolts that have worn threads or other flaws.
- Do not insert the point of a hook in an eye bolt. Use a shackle.

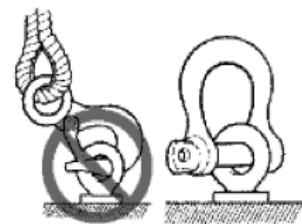

- Loads may slip or fall if proper eye bolt assembly and lifting procedures are not followed
 - A falling load can seriously injure or kill
 - Read and understand all instructions and follow warnings and safety instructions



Certified to DNV 2.7-1, type approval no. S-7732

For offshore container lifting and cold weather use with Charpy V-notch impact Value's of > 42 Joule At -40°C. All DNV links are specially heat treated after proof testing to minimize the risk of hydrogen embrittlement and stress corrosion cracking. Every link is batch coded for certificate recognition.

LINK - MASTER LINK, DNV 2.7-1+

- Material: Triple Alloy Steel
- Standard: EN 1677-4, ASME B30.26, DNV 2.7-1
- Finish: Painted Orange
- Design Factor: 5:1(Wire Sling)
- Identification: Trademark, Size/WLL, Batch Code
- Rated in Metric Ton(s)



Tolerance - Material: +/-5%, Dia. +/- 2.5mm, Internal Width and Length: +10%

Type	Dimensions (mm)			WLL 5:1 (t)	Wt. / ea. (kg)	Price / ea.	Part Number
	Dia.	Inside Leghth	Inside Width				
OML160DNV	16.0	150	75	4.10	0.68	67.88	2-MA16MLS
OML220DNV	22.0	270	140	7.0	2.28	147.78	2-MA22MLS
OML250DNV	25.5	270	140	9.3	3.11	163.66	2-MA25MLS
OML280DNV	28.0	270	140	14.5	3.78	175.65	2-MA28MLS
OML320DNV	32.0	270	140	19.0	5.02	239.71	2-MA32MLS
OML360DNV	36.0	270	140	26.0	6.46	298.57	2-MA36MLS
OML400DNV	40.0	280	155	30.5	8.46	470.43	2-MA40MLS
OML450DNV	45.0	320	175	40.0	12.18	607.32	2-MA45MLS
OML500DNVS	50.0	350	195	51.0	16.54	877.85	2-MA50MLS
OML650DNV	65.0	410	220	75.0	33.02	1983.41	2-MA65ML
OML750DNV	75.0	450	250	100.0	48.98	4668.86	2-MA75ML
OML900DNV	90	510	300	150.0	86.0	14932.90	2-MA90ML

LINK - MASTER LINK ASSEMBLY, DNV 2.7-1+

- Material: Triple pAlloy Steel
- Standard: EN 1677-4, ASME B30.26, DNV 2.7-1
- Finish: Painted Orange
- Design Factor: 5:1 (Wire Sling)
- Identification: Trademark, Size/WLL, Batch Code
- Rated in Metric Ton(s)

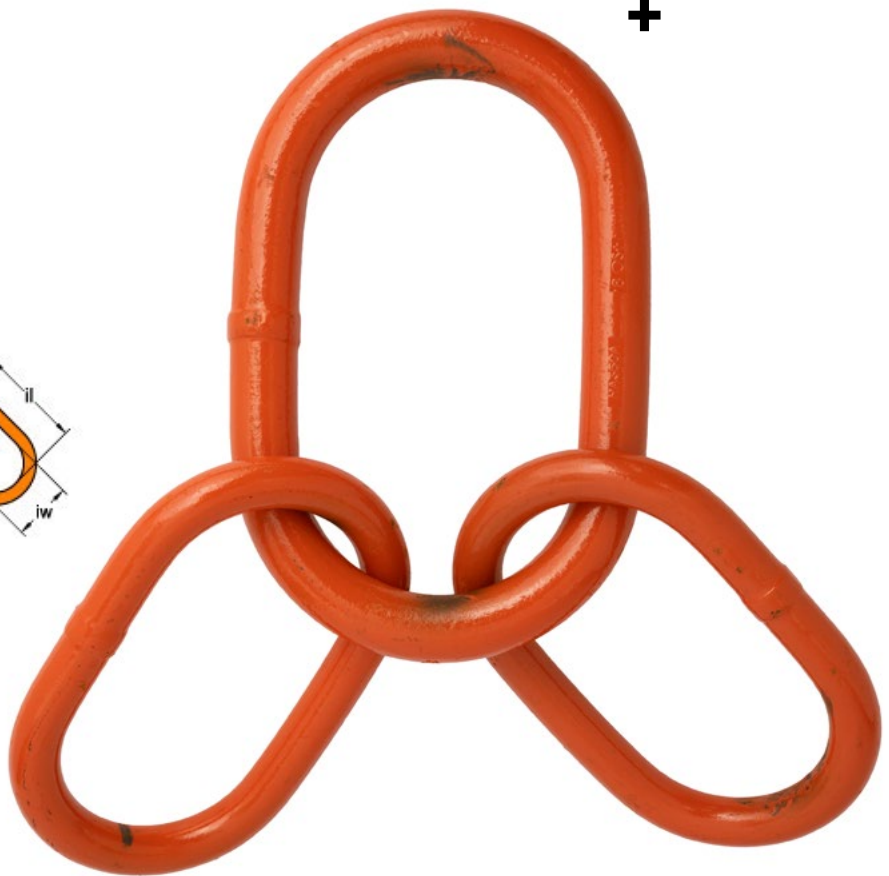
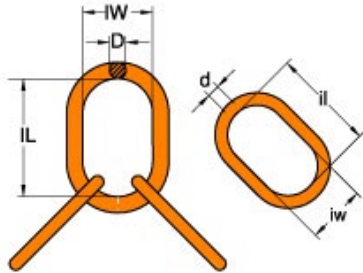

Tolerance - Material: +/-5%, Dia. +/- 2.5mm, Internal Width and Length: +10%

Type	Dimensions (mm)						WLL 5:1 (t)	Wt./ea. (kg)	Price / ea.	Part Number
	D	IL	IW	d	il	iw				
OSA160DNV	16	150	75	14.5	125	60	4.1	1.3	171.11	2-MA16QA
OSA220SDNV	22.0	162	90	22	162	90	11.0	4.41	355.09	2-MA22QASS
OSA250DNVS	25.5	270	140	22	162	90	9.30	6.05	377.54	2-MA25QAS
OSA260DNVS	28.0	270	140	22	162	90	14.5	5.89	413.55	2-MA26QAS
OSA320DNV	32.0	270	140	28	200	110	19.0	10.92	611.47	2-MA32QAS
OSA360DNV	36.0	270	140	28	200	110	26.0	12.35	858.75	2-MA36QAS
OSA400DNV	40.0	280	155	32	270	140	30.5	18.5	971.63	2-MA40QAS
OSA450DNV	45.0	320	175	36	270	140	40.0	25.09	1668.99	2-MA45QAS
OSA500DNVS	50.0	350	195	45	320	175	51.0	40.89	2697.62	2-MA50QAS
OSA650DNV	65.0	410	220	50	350	195	75.0	66.1	5563.29	2-MA65QA
OSA750DNV	75.0	450	250	65	410	220	100.0	115.02	10732.66	2-MA75QA
OSA900DNV	90.0	510	300	70	400	200	150.0	164.1	28656.82	2-MA90QA

LINK - PEAR, WELDLESS SLING

- Standard: RR-C-271F
- Finish: Galvanized
- Design Factor: 5:1
- Identification: Trademark, Size/WLL, Batch Code



Size (in)	WLL (lb)	Weight (lb)	Inside Length (in)	I. Width Sm. End (in)	I. Width Lg. End (in)	Price / ea.	Part Number
3/8	1800	0.13	2-1/4	3/4	1-1/2	6.68	6-3/8"PLG
1/2	2900	0.55	3	1	2	9.91	6-1/2"PLG
5/8	4200	1.10	3-3/4	1-1/4	2-1/2	14.37	6-5/8"PLG
3/4	6000	1.95	4-1/2	1-1/2	3	27.95	6-3/4"PLG
7/8	8300	2.78	5-1/4	1-3/4	3-1/2	39.63	6-7/8"PLG
1	10 800	4.30	6	2	4	60.64	6-1"PLG
1 1/4	16 750	8.50	7-3/4	2-1/2	5	113.20	6-1-1/4"PLG

LINK - MASTER LINK, LARGE

Made in Holland

- Material: High Alloy Steel
- Design Factor: 4:1
- Identification: Trademark, Size/WLL, Batch Code
- Rated in Metric Ton(s)

*More sizes available from 105 to 1500 tonne WLL

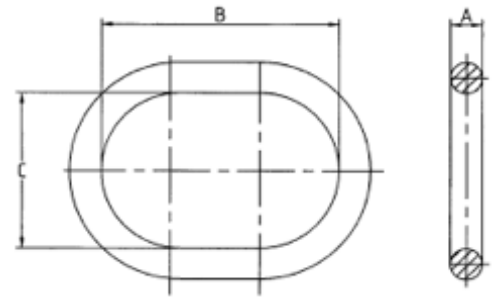

MBL (t)	WLL (t)	Dia. (mm)	In. Length (mm)	In. Width (mm)	Wt./ea. (kg)	Price / ea.	Part Number
525	105	80	450	250	56	Pricing on Request	116-ML105T
1250	250	115	600	400	163		116-ML250T
2000	500	175	800	400	603		116-ML500T
4000	1000	240	900	400	1226		116-ML1000T
6000	1500	270	1000	400	1712		116-ML1500T

RING - ROUND, WELDLESS

- Standard: RR-C-271F
- Finish: Painted Yellow
- Design Factor: 6:1
- Identification: Trademark, Size/WLL, Batch Code



Size (in)	WLL (lb)	Weight (lb)	Dimension (in)			Price / ea.	Part Number
			Dia.	I.D.	O.D.		
7/8 x 4	7200	2.72	7/8	4.00	5.75	52.48	6-7/8X4RR
7/8 x 5 1/2	5600	3.47	7/8	5.50	7.25	80.26	6-7/8X5-1/2RR
1 x 4	10 800	3.69	1	4.00	6.00	77.85	6-1X4RR
1 1/8 x 6	10 400	6.60	1 1/8	6.00	8.25	86.47	6-1-1/8X6RR
1 1/4 x 5	17 000	8.36	1 1/4	5.00	7.50	148.53	6-1-1/4X6RR
1 1/4 x 10	17 000	12.65	1 1/4	10.00	12.50	168.38	6-1-1/4X10RR

LINK - TWIN CLEVIS

Not for overhead lifting - Not for grade 80 or grade 100 material

- Material: Body: Heat Treated Carbon Steel, Pins: Alloy Steel
- Standard: EN 12195-3
- Finish: Zinc & Painted
- Design Factor: 4:1
- Identification: Size/WLL

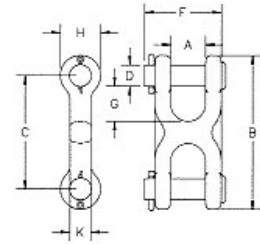

Size Chain (in)	WLL (lb)	Dimensions (in)								Price / ea.	Part Number
		A	B	C	D	F	G	H	K		
1/4 - 5/16	4700	0.47	2.50	1.16	0.38	1.31	0.43	0.94	0.50	7.56	6-1/4-5/16TCL
3/8	6600	0.53	2.81	1.81	0.44	1.80	0.50	1.00	0.56	8.71	6-3/8TCL
7/16 - 1/2	11 250	0.65	3.62	2.31	0.56	2.24	0.63	1.31	0.81	16.97	6-7/16-1/2TCL

LINK - QUICK

- Finish: Zinc & Stainless Steel



Size (in)	Wt. / ea. (lb)	Inside Length (mm)	Inside Width (mm)	Opening (mm)	WLL (lb)	Zinc Plated		Stainless Steel - 304SS		
						Price / ea.	Part Number	WLL (lb)	Price / ea.	Part Number
1/8	0.006	30	10	4	200	0.57	6-1/8"QL	330	2.12	6-1/8"SSQL
3/16	0.031	38	13	6	520	0.78	6-3/16"QL	600	2.64	6-3/16"SSQL
1/4	0.066	45	15	9	750	1.00	6-1/4"QL	950	3.51	6-1/4"SSQL
5/16	0.132	58	18	10	1525	1.91	6-5/16"QL	1350	6.62	6-5/16"SSQL
3/8	0.220	70	20	11	1800	3.27	6-3/8"QL	1700	9.20	6-3/8"SSQL
7/16	0.242	81	23	15	2550	4.44	6-7/16"QL	-	-	-
1/2	0.781	85	23	16	3300	5.02	6-1/2"QL	2975	18.76	6-1/2"SSQL

HOOK - "S"



- Finish: Zinc

Size	Length (mm)	Opening (mm)	Inside (mm)	Price / ea.	Part Number
4	35	6.0	11	0.77	6-4MMEGH
5	46	6.5	13	0.81	6-5MMEGH
6	54	7.0	15.5	1.19	6-6MMEGH
7	65	10.5	18.5	1.48	6-7MMEGH
8	75	12.5	22.5	1.98	6-8MMEGH
10	90	15.0	28	3.52	6-10MMEGH

HOOK - CARABINER, FISHING, SCREW LOCK

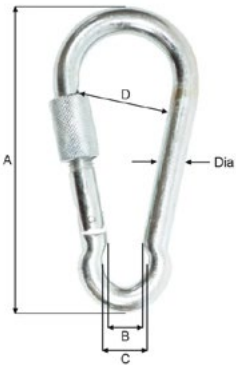

- Finish: Stainless Steel
- Material: 316 Stainless Steel

Size dia. (mm)	Size dia. (inch)	WLL (lb)	Weight / 100 pcs (lb)	Dimensions (mm)				Price / ea.	Part Number
				A	B	C	D		
6	1/4"	265	6.39	60	7	9	8	10.77	6-6X60SHSSSL
8	5/16"	500	15.87	80	9	13	8	12.93	6-8x80SHSSSL
11	7/16"	990	42.01	120	13	19	15	25.71	6-11X120SHSSSL

HOOK - SNAP

- Finish: Zinc & Stainless Steel
- Design Factor: 2.5:1



Size (mm)	O.L.		Wire Dia.		Wt. / ea. (lb)	Zinc plated			Stainless Steel - 304SS		
	(mm)	(in)	(mm)	(in)		WLL (lb)	Price / ea.	Part #	WLL (lb)	Price / ea.	Part #
5 x 50	50	2.00	5	3/16	0.022	200	0.76	6-5X50SH	220	2.58	6-5X50SHSS
6 x 60	60	2.36	6	1/4	0.062	240	0.85	6-6X60SH	260	2.99	6-6X60SHSS
7 x 70	70	2.75	7	9/32	0.099	360	1.54	6-7X70SH	396	4.27	6-7X70SHSS
8 x 80	80	3.16	8	5/16	0.154	460	1.54	6-8X80SH	500	5.01	6-8X80SHSS
10 x 100	100	4.00	10	3/8	0.317	700	2.33	6-10X100SH	770	8.90	6-10X100SHSS
12 x 140	140	5.50	12	1/2	0.595	760	4.92	6-12X140SH	1150	19.68	6-12X140SHSS
14 x 180	180	7.00	14	9/16	0.750	1120	12.17	6-14X180SH	-	-	-

SWIVEL - EYE & EYE

- Material: Forged Steel, quenched and tempered
- Standard: RR-C-271F, Type VII, Class 2
- Finish: Hot Dip Galvanized
- Design Factor: 5:1
- Identification: Trademark, Size/WLL

These swivels are positioning devices and are not intended to rotate under load.

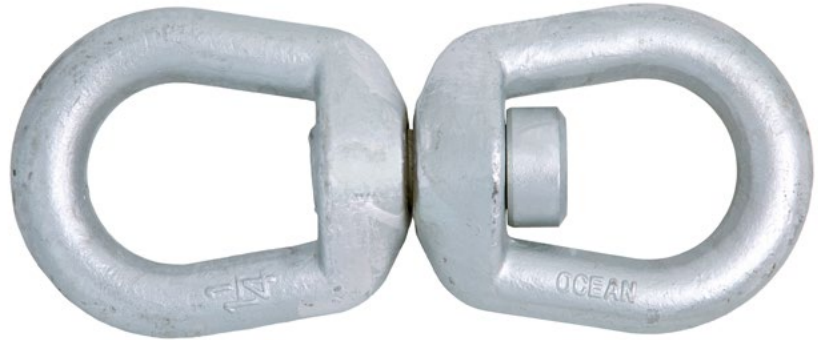
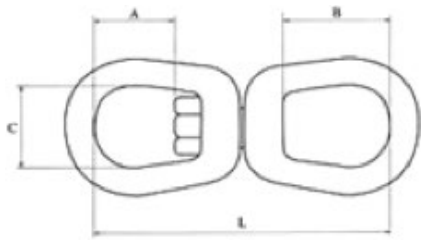

Rope (in)	WLL (lb)	Wt./ea. (lb)	Dimensions (in)				Price / ea.	Part Number
			A	B	C	L		
3/8	2250	0.71	0.94	1.50	1.25	4.31	9.80	6-3/8SWLEE
1/2	3600	1.32	1.31	2.00	1.50	5.44	15.81	6-1/2SWLEE
5/8	5200	2.49	1.56	2.38	1.75	6.56	24.33	6-5/8SWLEE
3/4	7200	4.02	1.75	2.43	2.00	7.19	39.22	6-3/4SWLEE
1	12 500	8.95	2.31	3.25	2.50	9.63	127.53	6-1SWLEE
1 1/4	18 000	16.37	2.89	3.89	3.13	11.44	326.86	6-1-1/4SWLEE
1 1/2	45 200	45.79	4.40	6.11	3.95	17.51	882.15	6-1-1/2SWLEE

SWIVEL - JAW & EYE

- Material: Forged Steel, quenched and tempered
- Standard: RR-C-271F, Type VII, Class 2
- Finish: Hot Dip Galvanized
- Design Factor: 5:1
- Identification: Trademark, Size/WLL

These swivels are positioning devices and are not intended to rotate under load.

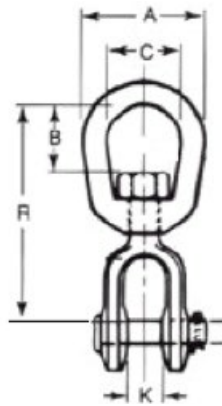

Rope (in)	WLL (lb)	Wt./ea. (lb)	Dimensions (in)					Length	Price / ea.	Part Number
			A	B	C	K	R			
3/8	2250	0.66	2.00	0.94	1.25	0.63	3.63	4.75	11.35	6-3/8SWLJE
1/2	3600	1.34	2.50	1.31	1.50	0.75	4.50	6.06	21.83	6-1/2SWLJE
5/8	5200	2.48	3.00	1.56	1.75	0.94	5.31	7.31	26.69	6-5/8SWLJE
3/4	7200	3.88	3.50	1.75	2.00	1.13	6.06	8.31	44.86	6-3/4SWLJE
1	12 500	9.84	4.50	2.31	2.40	1.75	8.56	11.69	137.06	6-1SWLJE
1 1/4	18 000	15.75	5.69	2.89	3.13	2.06	9.44	13.13	428.02	6-1-1/4SWLJE
1 1/2	45 200	54.75	7.00	3.88	4.00	2.88	14.25	20.84	1057.49	6-1-1/2SWLJE

SWIVEL - EYE & EYE

- Material: 304 Stainless Steel
- Finish: Stainless Steel
- Design Factor: Non-Load Rated

Size (in)	Price / ea.	Part Number
1/4	6.49	6-1/4SWEESS
5/16	14.26	6-5/16SWEESS
3/8	26.75	6-3/8SWEESS
1/2	61.02	6-1/2SWEESS
5/8	119.02	6-5/8SWEESS
3/4	161.87	6-3/4SWEESS



SWIVEL - EYE & EYE

- Material: 304 Stainless Steel
- Standard: RR-C-271F
- Finish: Stainless Steel
- Design Factor: 5:1
- Identification: Size/WLL
- Rated in Metric Ton(s)

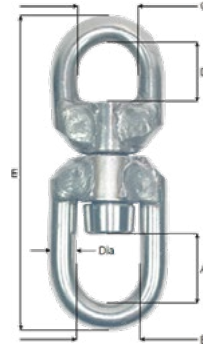

Size (mm)	WLL (t)	Wt./ea. (kg)	Dimensions (mm)					Price / ea.	Part Number
			A	B	C	D	E		
32	12.0	8.15	60	50	50	98	350	736.71	6-32SWEESS



SWIVEL - BULLET STYLE, ANGULAR CONTACT BEARING

- Minimum Ultimate Load is 5 times the Working Load Limit
- Proof Load is 2 times the Working Load Limit
- Rated in Metric Ton(s)

- All Swivels are manufactured using the highest grade of material available
- Tested to 2 times the Working Load Limit with certification
- Zinc plated for corrosion resistance and longer life
- Grease fittings for superior performance
- Designed for low starting torque and high rotation speed
- 20,000 cycle fatigue rated to 1.5 times WLL
- 100% Magnaflux crack detection
- All parts with batch number for quality certified and traceability
- Rated in Metric Ton(s)

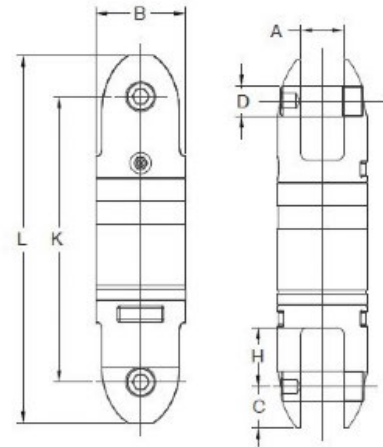

Wire Size (in)	WLL (t)	Dimensions (in)							Wt./ea. (lb)	Price / ea.	Part Number
		B	K	L	C	A	D	H			
1/2"	3	2.01	5.85	7.52	0.84	0.75	0.63	0.95	4.85	1,526.00	3-301-03
5/8"	5	2.48	7.87	10.20	1.16	1.00	0.87	1.56	8.73	2,576.00	3-301-05
3/4"	8.5	3.07	9.80	12.31	1.25	1.28	1.00	2.13	18.95	3,255.00	3-301-085
7/8"	10	4.27	13.11	16.73	1.81	1.77	1.50	3.25	40.77	3,899.00	3-301-10
1"	15	4.27	13.50	17.13	1.81	1.77	1.50	3.25	41.88	4,004.00	3-301-15

SWIVEL - EYE & EYE, ANGULAR CONTACT BEARING

- Minimum Ultimate Load is 5 times the Working Load Limit
- Proof Load is 2 times the Working Load Limit
- Rated in Metric Ton(s)

- All Swivels are manufactured using the highest grade of material available
- Tested to 2 times the Working Load Limit with certification
- Zinc plated for corrosion resistance and longer life
- Grease fittings for superior performance
- Designed for low starting torque and high rotation speed
- 20,000 cycle fatigue rated to 1.5 times WLL
- 100% Magnaflux crack detection
- All parts with batch number for quality certified and traceability
- Rated in Metric Ton(s)

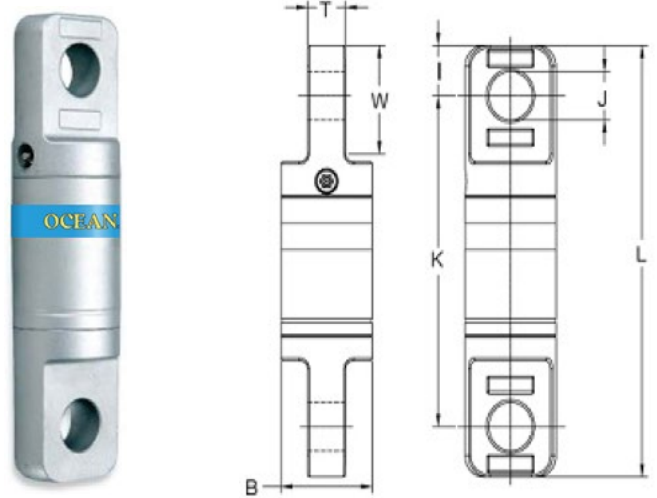

Wire Size (in)	WLL (t)	Dimensions (in)							Wt./ea. (lb)	Price / ea.	Part Number
		B	K	L	I	T	J	W			
1/2"	3	2.01	6.50	8.50	1.00	0.75	0.91	2.00	4.41	1,393.00	3-306-03
5/8"	5	2.48	8.33	10.71	1.19	1.00	1.28	2.62	8.82	2,583.00	3-306-05
3/4"	8.5	3.07	10.18	13.17	1.50	1.25	1.41	3.26	15.43	3,017.00	3-306-085
7/8"	10	4.27	13.46	17.11	1.82	1.72	1.65	4.76	41.88	3,836.00	3-306-10
1"	15	4.27	13.25	17.50	2.13	2.00	2.03	4.82	42.32	3,990.00	3-306-15

SWIVEL - JAW & JAW, ANGULAR CONTACT BEARING

- Minimum Ultimate Load is 5 times the Working Load Limit
- Proof Load is 2 times the Working Load Limit
- Rated in Metric Ton(s)
- All Swivels are manufactured using the highest grade of material available
- Tested to 2 times the Working Load Limit with certification
- Zinc plated for corrosion resistance and longer life
- Grease fittings for superior performance
- Designed for low starting torque and high rotation speed
- 20,000 cycle fatigue rated to 1.5 times WLL
- 100% Magnaflux crack detection
- All parts with batch number for quality certified and traceability
- Rated in Metric Ton(s)

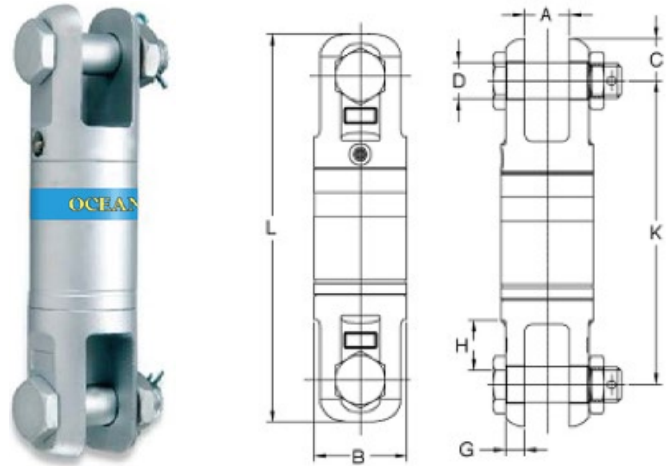

Wire Size (in)	WLL (t)	Dimensions (in)								Wt./ea. (lb)	Price / ea.	Part Number
		B	K	L	C	A	D	H	G			
1/2"	3	2.01	6.58	8.50	0.94	0.75	0.79	0.79	0.38	4.85	1,533.00	3-303-03
5/8"	5	2.48	8.42	10.71	1.15	1.00	0.87	1.11	0.56	9.92	2,842.00	3-303-05
3/4"	8.5	3.07	10.36	13.17	1.41	1.56	1.18	1.43	0.56	15.43	3,192.00	3-303-085
7/8"	10	4.27	14.02	17.17	1.57	1.75	1.54	2.70	0.83	40.77	3,864.00	3-303-10
1"	15	4.27	14.41	17.60	1.75	1.75	1.54	2.70	0.81	41.88	3,969.00	3-303-15

SWIVEL - CLOSED BODY SWIVEL, GN®



Made in Holland

- Material: High Tensile Steel
- Finish: Painted
- Design Factor: 5:1
- Temperature Range: -20°C up to +200°C
- Certification: Certificate of Conformity (on request)
3.1 material certificate EN 10204 (on request)
- Rated in Metric Ton(s)

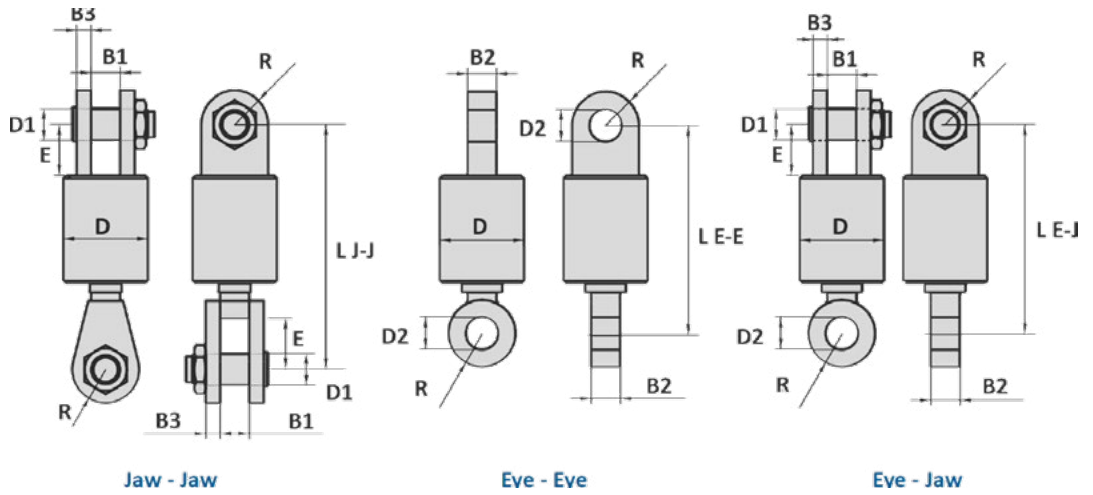

WLL (ton)	Dimensions (mm)											Wt. J-J (kg)	Wt. E-E (kg)	Wt. E-J (kg)	Price	Part Number
	B1	B2	B3	D1	D2	D	E	L J-J	L E-E	L E-J	R					
17	65	55	28	63	65	170	130	480	410	480	70	59	44	55	Pricing on Request	116-17CBS
25	76	70	30	70	72	190	145	565	450	535	70	84	64	77		116-25CBS
35	90	80	40	80	82	250	175	690	540	645	85	168	133	156		116-35CBS
55	110	100	50	100	103	270	175	800	690	785	105	274	213	254		116-55CBS
70	110	100	55	108	111	290	170	810	700	810	115	323	252	275		116-70CBS
85	130	120	75	127	130	350	175	870	830	855	135	529	404	448		116-85CBS
120	155	140	90	152	155	430	190	890	920	925	170	851	663	734		116-120CBS
150	170	160	100	178	181	470	210	1003	960	1038	190	1170	892	990		116-150CBS
200	190	170	110	190	193	530	250	1150	1060	1180	220	1726	1224	1424		116-200CBS
250	210	190	120	250	253	600	280	1240	1170	1300	260	2587	1737	2090		116-250CBS
300	250	190	175	290	293	750	300	1350	1280	1440	300	4320	2769	3438	116-300CBS	

BLOCK - TRY NET

- **Roller Bearing and Grease Nipple**
- Finish: Galvanized
- Design Factor: 4:1
- Identification: Trademark, Size/WLL
- Rated in Metric Ton(s)

WLL (t)	Size (in)	Wt. (lb)	Price / ea.	Part Number
5	6	24	391.00	6-6"TNB
10	8	56	638.12	6-8"TNB



BLOCK - YARDING



- **Roller Bearing and Grease Nipple**
- Material: Steel
- Finish: Painted, Red
- Design Factor: 4:1
- Identification: Size/WLL
- Rated in Metric Ton(s)

Wire size (in)	WLL (t)	Size (in)	Qty. / box	Wt. (lb)	Price / ea.	Part Number
1/4 - 5/16	1.5	3	10	3	49.35	6-3"YB
3/8	3	4	10	6	77.25	6-4"YB
1/2	4.5	5	5	9	125.60	6-5"YB
9/16	6	6	2	14	192.15	6-6"YB
5/8	8	8	2	32	337.44	6-8"YB

A potential hazard exists when lifting or dragging heavy loads with tackle block assemblies. Failure to design and use tackle block systems properly may cause a load to slip or fall, the result could be serious injury or death. A tackle block system should be rigged by a qualified person as defined by ANSI/ASME B30.

BLOCK - CHAIN

- **Roller Bearing and Grease Nipple**
- **Roller for 3/8" chain**
- Material: Steel
- Standard: EN 13157
- Finish: Painted
- Design Factor: 4:1
- Identification: Trademark, Size/WLL
- Rated in Metric Ton(s)

WLL (t)	Wt. (lb)	Price / ea.	Part Number
5	9	127.76	6-CBE14



BLOCK - GIN



- **Ball bearing, with hook and latch**
- **For Manila Rope**
- Material: Steel
- Standard: BS 1692
- Finish: Painted
- Design Factor: 3:1
- Identification: Trademark, Size/WLL

Sheave Size (in)	WLL (lb)	Rope Dia. (in)	Rim Width (in)	Wt. (lb)	Price / ea.	Part Number
12	1000	1	1 3/8	12.7	149.00	6-12"GB

A potential hazard exists when lifting or dragging heavy loads with tackle block assemblies. Failure to design and use tackle block systems properly may cause a load to slip or fall, the result could be serious injury or death. A tackle block system should be rigged by a qualified person as defined by ANSI/ASME B30.

BLOCK - SHEAVE BRONZE BRUSHED

- Material: Steel
- Standard: EN 13157
- Finish: Painted
- Design Factor: 4:1

Sheave Dia. (in)	Bore dia. (mm)	Wire Dia. (in)	Qty. / box	Price / ea.	Part Number
5	24	1/2	13	40.36	6-5"SBB
6	32.5	5/8	5	60.84	6-6"SBB
8	35	7/8	5	112.25	6-8"SBB



BLOCK - SINGLE OR DOUBLE SHEAVE, WOODEN, WITH HOOK

For use with fibre rope

- Standard: EN 13157
- Finish: Galvanized
- Design Factor: 4:1
- Identification: Trademark, Size/WLL

Shell Size (in)	Rope Dia. (in)	Sheave Size (in)			Wt. (lb)	SINGLE BLOCKS			DOUBLE BLOCKS		
		O.D.	Rim	Pin		WLL (lb)	Price / ea.	Part Number	WLL (lb)	Price / ea.	Part Number
3	3/8	1 3/4	1/2	3/8	1	500	35.00	6-3"SWBH	800	56.82	6-3"DWBH
4	1/2	2 1/4	5/8	3/8	2	1000	46.85	6-4"SWBH	1400	82.50	6-4"DWBH
5	5/8	3	3/4	3/8	2.5	1200	66.40	6-5"SWBH	1800	113.55	6-5"DWBH
6	3/4	3 1/2	1	1/2	4	1800	92.67	6-6"SWBH	2500	176.95	6-6"DWBH
8	1	4 3/4	1 1/8	5/8	9.5	2800	169.02	6-8"SWBH	3800	291.37	6-8"DWBH

A potential hazard exists when lifting or dragging heavy loads with tackle block assemblies. Failure to design and use tackle block systems properly may cause a load to slip or fall, the result could be serious injury or death. A tackle block system should be rigged by a qualified person as defined by ANSI/ASME B30.

BLOCK - SNATCH, SINGLE SHEAVE, WOODEN, WITH HOOK

For use with fibre rope, opens for easy access

- Standard: EN 13157
- Finish: Galvanized
- Design Factor: 4:1
- Identification: Trademark, Size/WLL

Rope Dia. (in)	WLL (lb)	Sheave Size (in)	Wt. (lb)	Price / ea.	Part Number
7/8	2400	6	8	179.00	6-7/8X6SB
1 1/8	4800	8	12	229.50	6-11/8X8SB



BLOCK - PULLEY



- For use with fibre rope
- Material: Stainless Steel
- Finish: Stainless Steel
- Design Factor: 4:1
- Identification: Trademark, Size/WLL

Rope Dia. (in)	Break Load (lb)	Diameter (in)	Price / ea.	Part Number
3/8	1900	1 1/4	19.30	6-PBSS3/8
5/8	3200	2	36.30	6-PBSS5/8

A potential hazard exists when lifting or dragging heavy loads with tackle block assemblies. Failure to design and use tackle block systems properly may cause a load to slip or fall, the result could be serious injury or death. A tackle block system should be rigged by a qualified person as defined by ANSI/ASME B30.

BLOCK - SNATCH, SINGLE SHEAVE, LIGHT DUTY, TAIL BOARD, OCEAN® BRAND

- Material: Manufactured from the highest quality tensile steel, forged swivel tees, yokes and end fittings.
- Finish: Light blue body for quick recognition
- Identification: Manufacturer, Rated Load, Rope Size(s)
- Furnished with Bronze Bushings and Grease Nipples
- Blocks open for easy wire installation.
- Design Factor: 4:1
- Standard: EN 13157
- Rated in Metric Load(s)

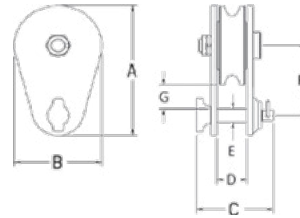

Wire Dia. (in)	Sheave Dia. (in)	WLL (t)	Dimensions (in)							N.W. (lb)	Price / ea.	Part Number
			A	B	C	D	E	F	G			
5/16 - 3/8	3	2	4.87	3.00	2.64	1.04	0.50	2.62	0.87	3	61.72	6-3"406SB
3/8 - 1/2	4 1/2	4	7.75	4.25	3.13	1.56	0.75	4.25	1.63	8	135.00	6-4-1/2"406SB
5/8 - 3/4	6	8	9.87	6.00	4.19	1.80	1.00	5.12	1.62	15	258.24	6-6"406SB
3/4 - 7/8	6	12	9.87	6.00	4.19	1.80	1.00	5.12	1.62	24	297.00	6-6"406SBL
1 - 1-1/8	8	15	13.56	8.12	6.00	2.55	1.25	6.75	2.37	35	495.00	6-8"406SB

BLOCK - SNATCH, DOUBLE SHEAVE, LIGHT DUTY, WITH HOOK, OCEAN® BRAND

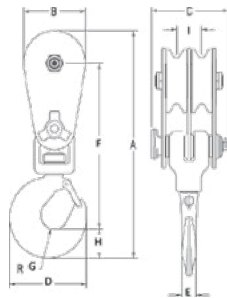

- Material: Manufactured from the highest quality tensile steel, forged swivel tees, yokes and end fittings
- Finish: Yellow end fittings, light blue body for quick recognition
- Identification: Manufacturer, Rated Load, Rope Size(s)
- Furnished with Bronze Bushings and Grease Nipples
- Blocks open for easy wire installation.
- Design Factor: 4:1
- Standard: EN 13157
- Rated in Metric Load(s)

Wire Dia. (in)	Sheave Dia. (in)	WLL (t)	Dimensions (in)									N.W. (lb)	Price / ea.	Part Number
			A	B	C	D	E	F	G	H	I			
3/8 - 1/2	4 1/2	4	14.77	4.24	5.25	5.24	1.00	10.78	0.94	1.87	1.72	20	367.90	6-4-1/2"408SB
5/8 - 3/4	6	12	21.12	6.00	6.13	7.86	1.56	15.50	1.44	2.62	2.62	49	577.20	6-6"408SB
5/8 - 3/4	8	12	23.18	8.12	6.13	7.86	1.56	16.50	1.44	2.62	2.03	59	699.90	6-8"408SB

BLOCK - SNATCH, DOUBLE SHEAVE, LIGHT DUTY, WITH SHACKLE, OCEAN® BRAND

- Material: Manufactured from the highest quality tensile steel, forged swivel tees, yokes and end fittings
- Finish: Light blue body for quick recognition
- Identification: Manufacturer, Rated Load, Rope Size(s)
- Furnished with Bronze Bushings and Grease Nipples
- Blocks open for easy wire installation.
- Design Factor: 4:1
- Standard: EN 13157
- Rated in Metric Load(s)

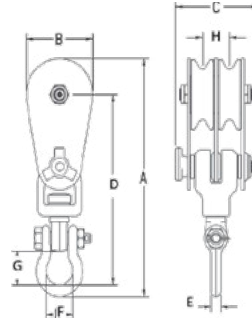

Wire Dia. (in)	Sheave Dia. (in)	WLL (t)	Dimensions (in)								N.W. (lb)	Price / ea.	Part Number
			A	B	C	D	E	F	G	H			
3/8 - 1/2	4 1/2	4	14.03	4.24	5.25	11.22	0.62	1.70	2.01	1.72	20	374.78	6-4-1/2"409SB
5/8 - 3/4	6	12	21.12	6.00	6.13	16.36	1.50	3.12	3.12	2.03	49	610.28	6-6"409SB
5/8 - 3/4	8	12	23.17	8.12	6.13	17.36	1.50	3.12	3.12	2.03	59	710.40	6-8"409SB



BLOCK - SNATCH, SINGLE SHEAVE, ALLOY, WITH HOOK, OCEAN® BRAND

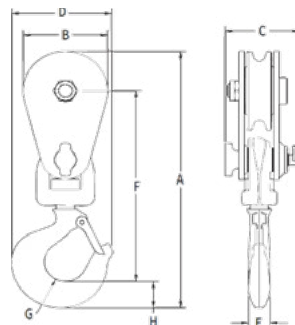

- Material: Manufactured from the highest quality alloy steel, forged swivel tees, yokes and end fittings
- Finish: Yellow for quick recognition
- Identification: Manufacturer, Rated Load, Rope Size(s)
- Furnished with Bronze Bushings and Grease Nipples
- Blocks open for easy wire installation
- Design Factor: 4:1
- Standard: EN 13157
- Rated in Metric Load(s)

Wire Dia.		Sheave Dia. (in)	WLL (t)	Dimensions (in)								N.W. (lb)	Price / ea.	Part Number
(mm)	(in)			A	B	C	D	E	F	G	H			
19-22	3/4 - 7/8	10	12	24.02	10.12	4.19	7.88	1.56	16.34	1.44	2.62	61	1,024.35	6-10"416SB

BLOCK - SNATCH, SINGLE SHEAVE, ALLOY, WITH SHACKLE, OCEAN® BRAND

- Material: Manufactured from the highest quality alloy steel, forged swivel tees, yokes and end fittings
- Finish: Yellow for quick recognition
- Identification: Manufacturer, Rated Load, Rope Size(s)
- Furnished with Bronze Bushings and Grease Nipples
- Blocks open for easy wire installation.
- Design Factor: 4:1
- Standard: EN 13157
- Rated in Metric Load(s)

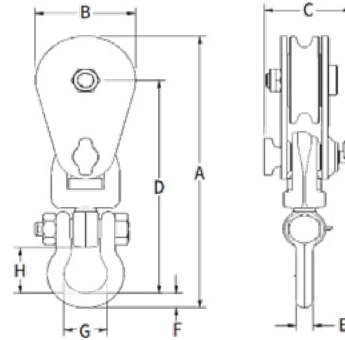

Wire Dia.		Sheave Dia. (in)	WLL (t)	Dimensions (in)								N.W. (lb)	Price / ea.	Part Number
(mm)	(in)			A	B	C	D	E	F	G	H			
19-22	3/4 - 7/8	10	12	23.06	10.12	4.19	16.75	1.25	1.25	3.00	3.47	57	1,071.06	6-10"417SB

BLOCK - SNATCH, SINGLE SHEAVE, LIGHT DUTY, WITH HOOK, OCEAN® BRAND

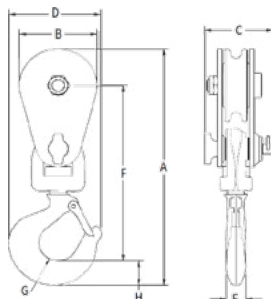

- Material: Manufactured from the highest quality tensile steel, forged swivel tees, yokes and end fittings.
- Finish: Yellow end fittings, light blue body for quick recognition
- Identification: Manufacturer, Rated Load, Rope Size(s)
- Furnished with Bronze Bushings and Grease Nipples
- Blocks open for easy wire installation.
- Design Factor: 4:1
- Standard: EN 13157
- Rated in Metric Load(s)

Wire Dia. (in)	Sheave Dia. (in)	WLL (t)	Dimensions (in)								N.W. (lb)	Price / ea.	Part Number
			A	B	C	D	E	F	G	H			
5/16 - 3/8	3	2	9.30	3.00	2.64	3.65	0.60	6.05	1.09	0.96	5	73.46	6-3"418SB
3/8 - 1/2	4 1/2	4	14.50	4.24	3.13	4.88	1.30	9.00	1.60	1.55	12	139.10	6-4-1/2"418SB
5/8 - 3/4	6	8	18.50	6.00	4.19	6.40	1.52	10.60	2.15	2.00	27	269.52	6-6"418SB
5/8 - 3/4	8	8	20.25	8.12	4.19	6.40	1.52	11.00	2.15	2.00	37	317.50	6-8"418SB

BLOCK - SNATCH, SINGLE SHEAVE, LIGHT DUTY, WITH SHACKLE, OCEAN® BRAND

- Material: Manufactured from the highest quality tensile steel, forged swivel tees, yokes and end fittings
- Finish: Yellow end fittings, light blue body for quick recognition
- Identification: Manufacturer, Rated Load, Rope Size(s)
- Furnished with Bronze Bushings and Grease Nipples
- Blocks open for easy wire installation
- Design Factor: 4:1
- Standard: EN 13157
- Rated in Metric Load(s)

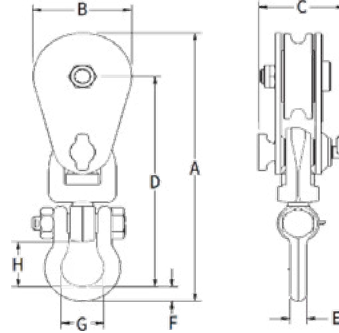

Wire Dia. (in)	Sheave Dia. (in)	WLL (t)	Dimensions (in)								N.W. (lb)	Price / ea.	Part Number
			A	B	C	D	E	F	G	H			
5/16 - 3/8	3	2	9.27	3.00	2.64	7.27	0.50	0.50	1.32	1.56	5	75.82	6-3"419SB
3/8 - 1/2	4 1/2	4	13.38	4.24	3.13	10.57	0.62	0.69	1.70	2.00	12	139.05	6-4-1/2"419SB
5/8 - 3/4	6	8	18.93	6.00	4.19	14.68	1.25	1.25	3.00	3.47	27	281.60	6-6"419SB
5/8 - 3/4	8	8	20.99	8.12	4.19	15.68	1.25	1.25	3.00	3.47	34	334.00	6-8"419SB

BLOCK - SNATCH, SINGLE SHEAVE, WITH HOOK, OCEAN® BRAND

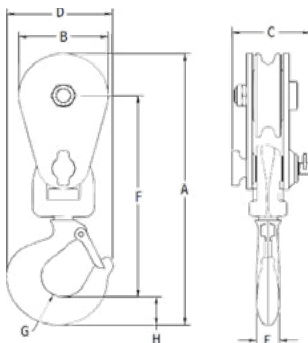

- Material: Manufactured from the highest quality tensile steel, forged swivel tees, yokes and end fittings
- Finish: Yellow end fittings, light blue body for quick recognition
- Identification: Manufacturer, Rated Load, Rope Size(s)
- Furnished with Bronze Bushings and Grease Nipples
- Blocks open for easy wire installation
- Design Factor: 4:1
- Standard: EN 13157
- Rated in Metric Load(s)

Wire Dia.		Sheave Dia. (in)	WLL (t)	Dimensions (in)								N.W. (lb)	Price / ea.	Part Number
(mm)	(in)			A	B	C	D	E	F	G	H			
19-22	3/4 - 7/8	8	15	23.50	8.12	5.09	8.34	1.76	16.51	1.50	2.93	51	629.10	6-8"420SBS
26-28	1 - 1 1/8	8	15	23.50	8.12	5.90	8.34	1.76	16.51	1.50	2.93	58	629.10	6-8"420SB

BLOCK - SNATCH, SINGLE SHEAVE, WITH SHACKLE, OCEAN® BRAND

- Material: Manufactured from the highest quality tensile steel, forged swivel tees, yokes and end fittings
- Finish: Yellow end fittings, light blue body for quick recognition
- Identification: Manufacturer, Rated Load, Rope Size(s)
- Furnished with Bronze Bushings and Grease Nipples
- Blocks open for easy wire installation
- Design Factor: 4:1
- Standard: EN 13157
- Rated in Metric Load(s)

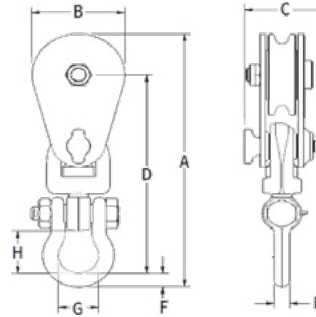

Wire Dia.		Sheave Dia. (in)	WLL (t)	Dimensions (in)								N.W. (lb)	Price / ea.	Part Number
(mm)	(in)			A	B	C	D	E	F	G	H			
19-22	3/4 - 7/8	8	15	23.50	8.12	5.09	17.19	1.50	1.75	3.12	3.12	63	662.96	6-8"421SB
26-28	1 - 1 1/8	8	15	23.50	8.12	5.25	17.19	1.50	1.75	3.12	3.12	59	662.56	6-8"421SBL

BLOCK - SNATCH, SINGLE SHEAVE, LARGE, SUPER DUTY, WITH HOOK, OCEAN® BRAND

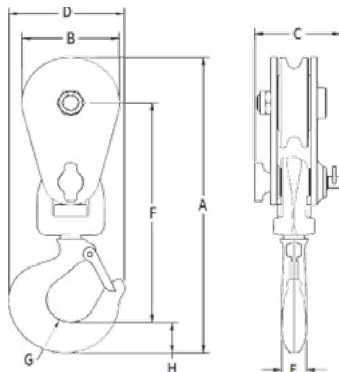

- Material: Manufactured from the highest quality tensile steel, forged swivel tees, yokes and end fittings
- Finish: Yellow end fittings, light blue body for quick recognition
- Identification: Manufacturer, Rated Load, Rope Size(s)
- Furnished with Bronze Bushings and Grease Nipples
- Blocks open for easy wire installation
- Design Factor: 4:1
- Standard: EN 13157
- Rated in Metric Load(s)

Wire Dia.		Sheave Dia. (in)	WLL (t)	Dimensions (in)								N.W. (lb)	Price / ea.	Part Number
(mm)	(in)			A	B	C	D	E	F	G	H			
25-29	1 - 1-1/8	8	20	25.84	8.12	6.00	9.39	2.00	18.43	1.50	3.38	102	1,819.50	6-8"430SB

BLOCK - SNATCH, SINGLE SHEAVE, LARGE, SUPER DUTY, WITH SHACKLE, OCEAN® BRAND

- Material: Manufactured from the highest quality tensile steel, forged swivel tees, yokes and end fittings.
- Finish: Yellow end fittings, light blue body for quick recognition
- Identification: Manufacturer, Rated Load, Rope Size(s)
- Furnished with Bronze Bushings and Grease Nipples
- Blocks open for easy wire installation.
- Design Factor: 4:1
- Standard: EN 13157
- Rated in Metric Load(s)

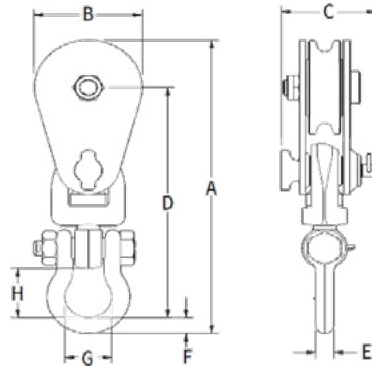

Wire Dia.		Sheave Dia. (in)	WLL (t)	Dimensions (in)								N.W. (lb)	Price / ea.	Part Number
(mm)	(in)			A	B	C	D	E	F	G	H			
25-29	1 - 1 1/8	8	20	26.57	8.12	6.00	19.76	2.00	2.75	3.72	4.00	110	1,906.00	6-8"431SB
25-28	1 - 1 1/8	18	25	41.36	18.25	7.13	29.12	2.00	3.12	3.50	4.81	322	5,207.00	6-18"431SB
25-28	1 - 1 1/8	20	30	52.40	20.25	8.31	38.34	2.50	3.94	5.62	7.06	418	9,982.99	6-20"431SB

A potential hazard exists when lifting or dragging heavy loads with tackle block assemblies. Failure to design and use tackle block systems properly may cause a load to slip or fall, the result could be serious injury or death. A tackle block system should be rigged by a qualified person as defined by ANSI/ASME B30.

BLOCK - SNATCH, SINGLE SHEAVE, HEAVY DUTY, WITH EYE, GN®

Made in Holland

- Sheave with Bronze Bearing
- Shackles, available from stock, must be ordered separately
- Material: Constructed of HD mild steel
- Standard: EN 13157
- Design Factor: 4:1
- Finish: Painted
- Rated in Metric Ton(s)

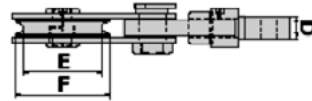
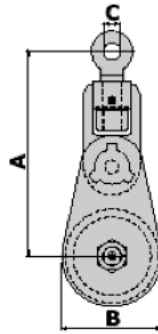

*Tolerance:

Forged parts +- 5%

Machined parts +- 1mm

Wire Dia.		WLL Eye Pull	A	B	C	D	E	F	Wt. (kg)	Price / ea.	Part Number
(in)	(mm)	(t)			(mm)						
1	22-25	17	490	160	44	57	110	150	49	Pricing on Request	116-6"SB
1 1/8	25-28	25	602	220	53	70	150	200	80		116-8"SB
1 1/4	28-32	25	632	270	53	70	190	250	93	8,095.50	116-10"SB
1 1/4	28-32	25	662	320	53	70	240	300	109	Pricing on Request	116-12"SB
1 1/4	28-32	25	692	370	53	70	290	350	116		116-14"SB
1 1/2	32-38	35	835	470	60	80	380	450	211	17,183.25	116-18"SB
1 1/2	32-38	35	865	520	60	80	430	500	238	Pricing on Request	116-20"SB
1 1/2	32-38	35	925	625	60	80	535	605	284		116-24"SB
1 5/8	38-42	55	1040	625	73	100	520	605	460	29,415.75	116-24"55TSB
1 7/8	44-48	85	1212	780	85	120	630	750	890		116-30"SB
2	50-55	120	1327	880	100	140	740	860	1200		116-34"SB
2 1/2	60-70	150	1427	930	113	160	760	910	1530	Pricing on Request	116-36"SB
3	75-85	200	1630	1080	135	170	870	1060	2285		116-42"SB
3 1/2	88-93	250	1785	1190	145	190	970	1170	3015		116-46"SB

A potential hazard exists when lifting or dragging heavy loads with tackle block assemblies. Failure to design and use tackle block systems properly may cause a load to slip or fall, the result could be serious injury or death. A tackle block system should be rigged by a qualified person as defined by ANSI/ASME B30.



- Since 1992, Wirop Industrial Co., Ltd. has been providing the load testing equipment worldwide. Wirop is a specialist in test beds across many different rigging and lifting gears. All these products have been part of many different fields including oil and gas, marine, and construction.
- Ever since its establishment in 1979 with continuous integration, Wirop is now extending its product line and commercializing its load monitoring products to the market. We implement the new generation

of load monitoring systems. Networking the load with our modern-day computerized products. We are proud to be able to offer this load monitor system to global market. All the load monitoring products are designed, developed and manufactured by our motivated and mixed discipline engineering team.

LOAD CELL - WIRELESS KIT

Load Cell Kit includes:

- Load Cell (wireless)
- Handheld Reader (wireless)
- Carrying Case (< 75 t only, >= 75 t are in wooden crates)
- Instruction Manual(s)
- Certification (Calibration & Warranty)

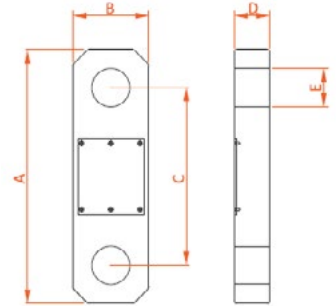

Capacity (t)	Accuracy (%)	Weight (kg)	Dimensions (mm)					Price	Part Number (kits)
			A	B	C	D	E		
5	0.3	2.9	275	104	196	48	27	8,789.45	176-5TLC
12	0.3	4.7	303	115	204	48	38	10,359.29	176-12TLC
35	0.3	11.4	410	132	248	69	60	13,323.00	176-35TLC
50	0.3	14.7	465	166	273	79	72	16,054.00	176-50TLC
100	0.3	42.0	615	213	335	122	99	27,008.00	176-100TLC
150	0.3	55.7	690	242	370	124	112	34,644.90	176-150TLC

- The wireless load link transmits the load value to a computer or handset device via radio channel. Aerospace grade aluminum alloy tension link provides high corrosion resistance capability and high level of robust design for rugged environment.
- The wireless communication distance ranges from 500 m to 600 m or even longer using IEEE 802.15.4 networking definition in license free band.

- Wirop engineering team has the leading power saving technology in the load monitoring industry. Talented engineering team has developed in medical grade noise filter technology coupled with ultra-low voltage operating system without losing high accuracy. The continuous reading battery life reaches 925 hours at data rate of 1 Hz.

	Wireless Load Link	Cable Load Link
Material:	Aerospace grade aluminium	
Battery:	AA battery x 4	
Operating hours:	280-950	
Safety factor:	5 times	
Data rate:	1-10 Hz	
System Range:	500 ~ 600 m	
Frequency:	2.4 GHz	
Operating temp:	-10°C ~ 60°C	
Storage temp:	-10°C ~ 70°C	
Sensitivity:	1.5 mV / V or above	
Input resistance:	430 ± 30 Ω	
Zero balance:	± 2%	
Max Excitation:	12 V	
Temp effect on zero:	0.03% / 10°C	
Temp effect on output:	0.05% / 10°C	
Safety overload:	150%	





Software Packages:

Wirop provides different software platforms for users to capture the load data. Currently, we provide Wi-Load, CertiPro, and Centre of Gravity. All the software packages work on Windows PC platform Win7, Win8, and Win10.

LOAD CELL - SOFTWARE PACKAGES

Software Package	Price	Part Number (kits)
Wi-Load Data Logging	2,872.00	176-DLSW
Certificate Generator	2,872.00	176-CGSW
Centre of Gravity	2,872.00	176-COGSW



The Wi-Load Data Logging software package:

is a user friendly, vibrant, and versatile wireless load cell monitoring package. Wi-load allows the user to instantly read load values from multiple load cells. It is capable of monitoring up to 96 load cells via live data. The logging data are saved in excel format, or CSV data file which can be opened for analysis.

The Certificate Generator software package:

USB reader coupled with Certificate Generator software package read and record the load of a single loadcell against time. It plots the graph showing load vs. time. The interface is similar to Wirop Testbed operating software. It helps the user to generate the test certificate instantly.

Centre of Gravity software package:

Wirop provides compression loadcells. Capacity ranges from 2.5 t to 100 t. The Compression loadcell coupled with the Centre of Gravity software package. The center of gravity can be easily found.

Readers:

Wirop developed two type of reading device, Mobile handset and the USB reader. The Mobile Handset reads the load data and records the peak, average, and displays the current load. The Mobile handset simultaneously monitors four wirop load cells. The USB reader sends the load data to the Windows based computers. The USB reader works with any software packages developed by Wirop IT team and provides different functionality for the customers.

Wireless Handset and Cable Handset:

USB reader coupled with Certificate Generator software package read and record the load of a single loadcell against time. It plots the graph showing load vs. time. The interface is similar to Wirop Testbed operating software. It helps the user to generate the test certificate instantly.

- Reading up to four Wirop wireless load cells at once.
- Showing the load in different units. kg, t, lb, kN.
- Recording the peak load of each load cell.
- Pre-set Zero.
- Peak Recoding
- Summing multiple load value.
- Wireless range up to 500-600 m in free space.
- Battery: Four AA batteries.
- Operating Temperature: -10°C ~ 50°C



USB Reader:

USB reader connects the loadcells with the computer.



HOOK - SNAP, WITH LATCH

- Material: Mild Steel
- Finish: Galvanized
- Design Factor: 4:1
- Identification: Trademark, Size/WLL

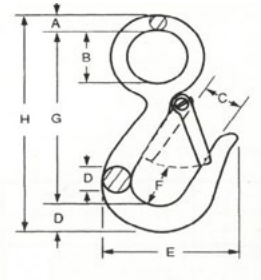

Size (in)	WLL (lb)	Wt. (lb)	Dimensions (in)						Price / ea.	Part Number
			A	B	C	D	E	F		
7/16	750	0.23	0.25	0.75	0.75	0.44	2.25	0.75	7.06	6-7/16GSH
9/16	1000	0.48	0.34	1.12	0.81	0.56	2.69	0.88	11.48	6-9/16GSH

HOOK - SORTING, WITH HANDLE

- Material: Steel
- Finish: Powder Coated
- Design Factor: 4:1
- Identification: Trademark, Size/WLL, Batch Code
- Rated in Metric Ton(s)

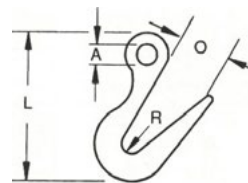

WLL Tip (t)	WLL Bottom (t)	Wt. (lb)	Dimensions (in)				Price / ea.	Part Number
			A	R	L	O		
2	7 1/2	6.25	1.38	.625	9.69	2.81	161.35	6-2TSH

HOOK - LANYARD, WITH DOUBLE LOCK

- Material: Mild Steel
- Finish: Zinc

Break Load (lb)	Price / ea.	Part Number
5000	13.40	6-DLLH



HOOK - EYE, SLIP, WITH LATCH

- Material: AISI Stainless Steel 316
- Finish: Stainless Steel
- Design Factor: 4:1
- Identification: Size/WLL

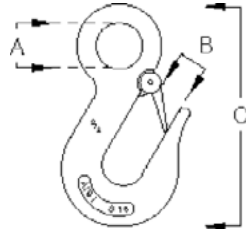

Chain Size (in)	WLL (lb)	Wt. / ea. (lb)	Dimensions (in)			Price / ea.	Part Number
			A	B	C		
3/8	2000	0.92	0.72	0.79	4.75	83.41	6-3/8SSESH
1/2	3000	1.90	0.93	1.06	6.00	157.18	6-1/2SSESH

HOOK - SWIVEL EYE, WITH LATCH

- Material: AISI Stainless Steel 316
- Finish: Stainless Steel
- Design Factor: 4:1
- Identification: Size/WLL

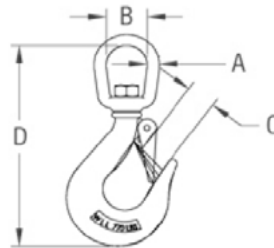

Size (in)	WLL (lb)	Dimensions (in)				Weight / ea. (lb)	Price / ea.	Part Number
		A	B	C	D			
1/4	770	0.25	0.83	0.75	4.55	0.40	36.91	6-1/4"SSSWH
5/16	1430	0.35	1.07	0.76	5.17	0.70	58.18	6-5/16"SSSWH

HOOK - CLEVIS, GRAB, GRADE 70

For use with Grade 70 or lower chains

Not for use with grade 80 chain and chain slings used in overhead lifting

- Material: Forged Alloy Steel, Quenched & Tempered
- Standard: EN 12195-3
- Finish: Gold Chromated
- Design Factor: 4:1
- Identification: Trademark, Size/WLL, Batch Code, G70

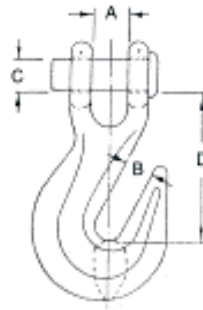

Chain Size (in)	WLL (lb)	Dimensions (in)				Wt. / ea. (lb)	Qty. / box	Price / ea.	Part Number
		A	B	C	D				
1/4	3150	0.36	0.40	0.38	1.97	0.40	100	5.45	6-1/4"CGH
5/16	4700	0.40	0.44	0.44	2.26	0.79	50	8.89	6-5/16"CGH
3/8	6600	0.48	0.50	0.47	2.63	1.00	50	11.45	6-3/8"CGH
7/16	8750	0.66	0.56	0.56	2.75	1.31	40	20.31	6-7/16"CGH
1/2	11 300	0.77	0.69	0.62	3.19	2.10	25	24.92	6-1/2"CGH

HOOK - CLEVIS, GRAB, WITH LATCH, GRADE 70

For use with Grade 70 or lower chains

Not for use with grade 80 chain and chain slings used in overhead lifting.

- Material: Forged Alloy Steel, Quenched & Tempered
- Standard: EN 12195-3
- Finish: Gold Chromated
- Design Factor: 4:1
- Identification: Trademark, Size/WLL, Batch Code, G70

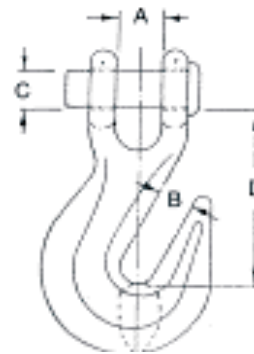

Chain Size (in)	WLL (lb)	Dimensions (in)				Wt. / ea. (lb)	Qty. / box	Price / ea.	Part Number
		A	B	C	D				
1/4	3150	0.36	0.40	0.38	1.97	0.40	100	11.21	6-1/4"CGHL
5/16	4700	0.40	0.44	0.44	2.26	0.79	50	13.25	6-5/16"CGHL
3/8	6600	0.48	0.50	0.47	2.63	1.00	50	16.34	6-3/8"CGHL
1/2	11 300	0.75	0.66	0.63	3.19	2.10	25	29.73	6-1/2"CGHL

HOOK - CLEVIS, SLIP, GRADE 70

For use with Grade 70 or lower chains

Not for use with grade 80 chain and chain slings used in overhead lifting

- Material: Forged Alloy Steel, Quenched & Tempered
- Standard: EN 12195-3
- Finish: Gold Chromated
- Design Factor: 4:1
- Identification: Trademark, Size/WLL, Batch Code, G70

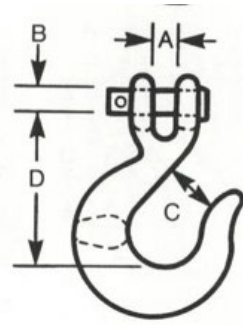

Chain Size (in)	WLL (lb)	Dimensions (in)				Wt. / ea. (lb)	Qty. / Box	Price / ea.	Part Number
		A	B	C	D				
1/4	3150	0.44	0.37	0.91	2.60	0.50	100	7.00	6-1/4"CSH
5/16	4700	0.50	0.43	1.10	2.85	0.75	50	9.57	6-5/16"CSH
3/8	6600	0.59	0.47	1.30	3.25	1.20	50	14.94	6-3/8"CSH
1/2	11 300	0.70	0.63	1.47	3.90	2.80	20	32.67	6-1/2"CSH
5/8	13 500	0.91	0.75	2.00	4.90	4.75	10	52.15	6-5/8"CSH

HOOK - CLEVIS, SLIP, WITH LATCH, GRADE 70

For use with Grade 70 or lower chains

Not for use with grade 80 chain and chain slings used in over head lifting

- Material: Forged Alloy Steel, Quenched & Tempered
- Standard: EN 12195-3
- Finish: Gold Chromated
- Design Factor: 4:1
- Identification: Trademark, Size/WLL, Batch Code, G70

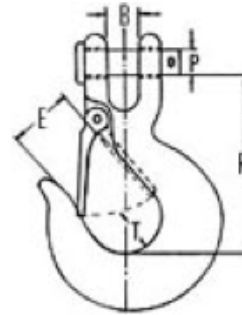

Chain Size (in)	WLL (lb)	Dimensions (in)				Wt. / ea. (lb)	Qty. / box	Price / ea.	Part Number
		B	E	P	R				
1/4	3150	0.44	0.73	0.38	2.44	0.50	100	7.62	6-1/4"CSHL
5/16	4700	0.58	1.03	0.42	2.83	0.75	50	10.08	6-5/16"CSHL
3/8	6600	0.59	1.29	0.47	3.33	1.20	50	16.39	6-3/8"CSHL
1/2	11 300	0.75	1.38	0.63	4.00	2.80	20	35.09	6-1/2"CSHL
5/8	13 500	0.93	2.00	0.75	4.94	4.75	10	66.82	6-5/8"CSHL

HOOK - EYE, HOIST, WITH LATCH

- Material: Forged Alloy & Carbon Steel, Quenched & Tempered
- Standard: EN 1677-5,-2
- Finish: Powder Coated (Yellow)
- Design Factor: 5:1
- Identification: Trademark, Size/Load, BatchCode, (Alloy)
- Rated in Metric Ton(s)

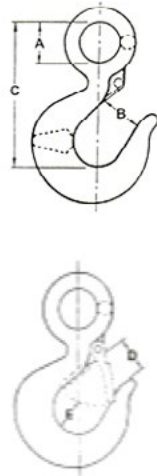

WLL (t)		Qty. / box	Dimensions (in)					Wt. / ea. (lb)	Carbon		Alloy	
Carbon	Alloy		A	B	C	D	E		Price / ea.	Part Number	Price / ea.	Part Number
3/4	1	80	0.75	0.94	3.22	0.88	0.81	0.5	7.76	6-3/4TCEH	6.81	6-1TAEH
1	1 1/2	50	0.91	1.03	3.66	0.97	0.81	0.8	8.14	6-1TCEH	8.80	6-1-1/2TAEH
1-1/2	2	40	1.12	1.06	4.09	1.00	0.84	1.1	14.62	6-1-1/2TCEH	13.63	6-2TAEH
2	3	40	1.25	1.22	4.69	1.12	1.19	1.7	17.92	6-2TCEH	18.55	6-3TAEH
3	4 1/2	30	1.56	1.50	5.78	1.34	1.38	3.6	36.91	6-3TCEH	37.80	6-4-1/2TAEH
5	7	10	2.00	1.88	7.38	1.69	1.78	6.7	74.41	6-5TCEH	75.28	6-7TAEH
7 1/2	11	5	2.44	2.25	9.06	2.06	2.12	13.0	134.91	6-7-1/2TCEH	138.01	6-11TAEH
10	15	5	2.84	2.50	10.06	2.27	2.56	18.5	228.16	6-10TCEH	251.78	6-15TAEH
15	22	2	3.50	3.30	12.53	3.02	2.88	33.8	498.53	6-15TCEH	567.91	6-22TAEH
	30	1	3.50	4.00	14.06	3.25	3.44	60.0			1563.64	6-30TAEH

NOTE: Proof Load is 2.5 times the working load limit for 3/4TC~22TA, 22TA~30TA is 2 times - Hooks Average straightening load (ultimate load) is five times the WLL for 0.75TC~22TA, 30TA is 4.5 times WLL. (1 tonne = 2204 lb)

SEE WARNING AND APPLICATION INFORMATION FOR HOOKS

HOOK - SWIVEL EYE, HOIST, WITH LATCH

- Material: Forged Alloy & Carbon Steel, Quenched & Tempered
- Standard: EN 1677-5,-2
- Finish: Powder Coated (Yellow)
- Design Factor: 5:1
- Identification: Trademark, Size/Load, Batch Code, (Alloy)
- Rated in Metric Ton(s)



WLL (t)		ID Ball Width (in)	Throat Opening no Latch (in)	Throat Opening with Latch (in)	Weight / ea. (lb)	Qty. / box	Carbon		Alloy	
Carbon	Alloy						Price / ea.	Part Number	Price / ea.	Part Number
3/4	1	1 1/4	15/16	7/8	0.78	50	13.07	6-3/4TSQLH	12.87	6-1TASWH
1	1 1/2	1 1/2	1 1/32	31/32	1.32	50	15.99	6-1TSQLH	20.31	6-1-1/2TASWH
1 1/2	2	1 3/4	1 1/16	1	2.02	30	26.31	6-1-1/2TSQLH	33.00	6-2TASWH
2	3	1 3/4	1 7/32	1 1/8	2.57	20	28.84	6-2TSQLH	35.95	6-3TASWH
3	4 1/2	2	1 1/2	1 11/32	4.89	10	54.45	6-3TSQLH	58.37	6-4-1/2TASWH
5	7	2 1/2	1 7/8	1 11/16	10.29	5	120.24	6-5TSQLH	148.29	6-7TASWH
	11	2 3/4	2 1/4	2 1/16	18.62	5			233.47	6-11TASWH
	15	3 1/8	2 1/2	2 1/4	25.43	2			364.72	6-15TASWH
	22	4 1/16	3 3/8	3 1/8	47.25	1			827.89	6-22TASWH
	30	4 1/16	4	3 1/4	70.50	1			1306.23	6-30TASWH

NOTE: Proof Load is 2 times the working load limit for 3/4TC~15TC and 30TA, 1TA~22TA is 2.5 times – Hooks Average straightening load (ultimate load) is five times the WLL for 0.75TC~15TC, 1TA~22TA is 4.5 times WLL and 30TA is 4 times WLL. (1 tonne = 2204 lb)

SEE WARNING AND APPLICATION INFORMATION FOR HOOKS

HOOK - LATCH KIT

- Stainless Steel Latch kits for Hoist Hooks
- Rated in Metric Ton(s)

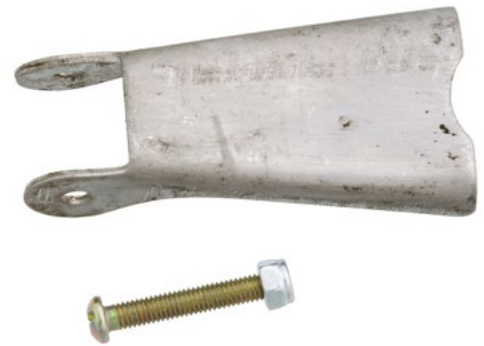
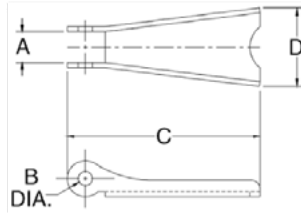

Hook Size (t)		Dimensions (in)				Wt./ ea.(lb)	Price / ea.	Part Number
Carbon	Alloy	A	B	C	D			
3/4	1	0.38	0.16	1.44	0.59	0.02	3.46	6-3/4TLK
1	1 1/2	0.38	0.16	1.60	0.59	0.02	4.40	6-1TLK
1 1/2	2	0.47	0.19	1.84	0.82	0.03	4.66	6-1-1/2TLK
2	3	0.47	0.19	2.00	0.92	0.03	4.59	6-2TLK
3	4-1/2	0.56	0.17	2.41	1.00	0.06	7.13	6-3TLK
5	7	0.58	0.20	2.97	1.21	0.11	8.77	6-5TLK
7 1/2 - 10	11 - 15	0.59	0.27	3.66	1.50	0.17	19.59	6-7-1/2-10TLK
15	22	0.83	0.39	4.94	1.90	0.39	30.17	6-15C-22ATLK
20	30	0.94	0.52	5.88	2.56	0.63	75.45	6-20C-30ATLK

HOOK - ANCHOR LINE HOOK, GN®



- Material: Cast steel
- Finish: Galvanized
- Design Factor: 4:1
- Temperature Range: -20°C up to +200°C
- Certification: Certificate of Conformity (on request)
- Rated in Metric Ton(s)

WLL (ton)	MBL (ton)	Dimensions (mm)					Weight (kg)	Price
		A	B	C	D	E		
15	60	38	58	343	32	45	11	Pricing on Request
20	80	40	74	343	32	60	14	
25	100	52	86	440	38	65	26	
50	200	80	112	618	45	90	67	
80	320	90	130	709	62	110	116	

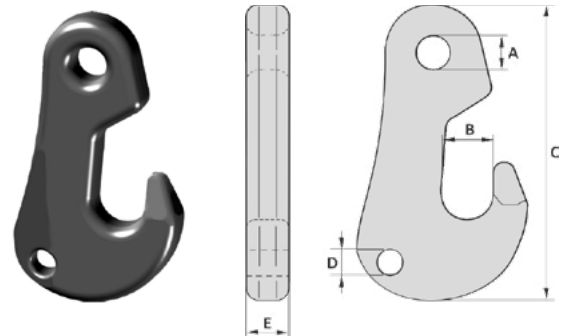

Tolerance: ± 5%

HOOK - EYE, ROV, WITH LATCH, GN®



Made in Holland

- Material: Alloy steel
- Finish: Painted
- Design Factor: 4:1
- Temperature Range: -40°C up to +200°C
- Certification: Certificate of Conformity (on request)
- 3.1 material certificate EN 10204 (on request)
- Rated in Metric Ton(s)
- Spare latches available on request.

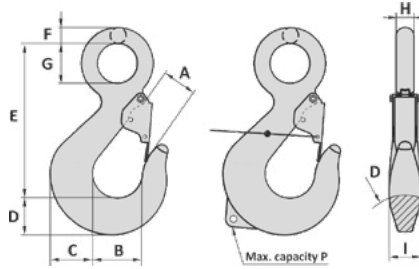

WLL (ton)	MBL (ton)	Dimensions (mm)									P (ton)	Wt. (kg)	Price	Part Number
		A	B	C	D	E	F	G	H	I				
8	32	54	68	53	48	203	25	50	25	38		3.7		-
12.5	50	71	86	68	51	253	32	64	32	48		7.6		-
16	64	81	96	76	68	284	36	72	36	53		10		-
20	80	91	107	86	76	319	40	81	40	61		13		116-SH20T
28	112	71	112	96	83	354	38	95	38	63		17		116-SH28
31	125	81	125	106	92	389	43	100	43	70		23		116-SH31T
40	160	93	140	116	103	457	48	130	48	80		34		116-SH40T
50	200	106	158	135	116	495	54	130	54	89		49		116-SH50T
63	250	119	176	151	130	565	60	150	60	99		63		116-SH63T
80	320	131	198	168	145	690	67	170	67	110		99		116-SH80T
100	400	151	225	195	172	725	79	175	79	125	4.75	160		116-SH100T
150	600	173	250	225	199	765	86	130	86	160	6.5	260		116-SH150T
200	800	200	275	260	237	850	102	150	102	180	8.5	417		116-SH200T
250	1000	233	310	290	269	928	120	170	120	200	9.5	576		116-SH250T
300	1200	264	350	330	310	1052	140	190	140	220	12	820		116-SH300T
400	1600	303	400	380	344	1195	170	210	170	240	17	1125		116-SH400
500	2000	370	450	410	390	1360	200	215	200	320	17	1840		-

Pricing on Request

Tolerance: Forged parts ± 5%, machined parts ± 1 mm

HOOK - ROV SHANK HOOK, GN®



- Material: Alloy steel
- Finish: Painted
- Design Factor: 4:1
- Temperature Range: -40°C up to +200°C
- Certification: Certificate of Conformity (on request)
- 3.1 material certificate EN 10204 (on request)
- Rated in Metric Ton(s)
- Spare latches available on request.

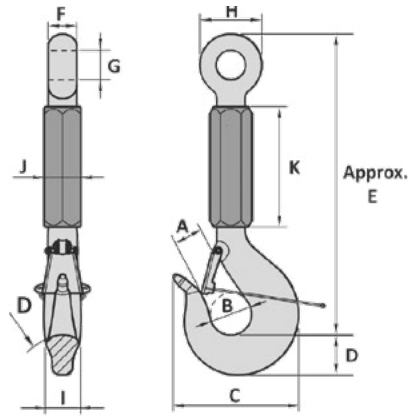

Tvoe for hook WLL 5.4 ton ≤ WLL 80 ton

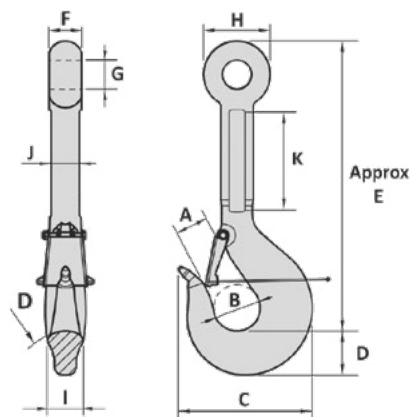

Tvoe for hook WLL 100 ton ≤ WLL 400 ton



WLL (ton)	Dimensions (mm)											Max. Tip Capacity ton	Wt. (kg)	Price
	A	B	C	D	E	F	G	H	I	J	K			
6.5	40	55	182	50	400	30	28	60	45	50	225		8	Pricing on Request
8.5	54	68	208	55	450	30	31	75	50	56	228		11	
12	63	80	254	70	480	41	40	78	55	61	227		16	
17	71	90	297	85	514	48	44	88	60	67	226		22	
25	92	110	344	100	574	56	52	105	70	78	233		34	
35	108	130	395	120	628	58	60	124	85	96	230		56	
42.5	69	100	316	95	780	70	70	150	75	85	330		47	
55	81	112	343	106	808	80	78	162	85	100	350		62	
63	91	125	376	118	950	85	86	180	95	110	360		92	
85	104	140	418	132	893	100	86	200	106	120	290		111	
100	140	175	472	150	831	110	100	228	120	120	240	4.75	178	
125	145	180	509	170	890	124	110	260	140	140	240	4.75	249	
160	157	190	614	190	953	138	135	300	160	150	250	6.5	362	
200	176	224	688	230	998	148	135	350	175	150	250	8.5	496	
250	194	250	780	256	1063	175	145	370	200	160	250	8.5	671	
300	210	280	755	255	1153	190	155	360	220	170	300	9.5	790	
400	234	315	855	305	1253	210	185	420	240	190	300	9.5	1064	

HOOK - EYE, HOIST, GRADE 100, YOKE® BRAND

- Material: Alloy Steel, Grade 100
- Standard: EN 1677-5 / ASTM A952/952M
- Finish: Powder Coated, Blue
- Design Factor: 5:1
- Identification: Trademark, Size/WLL, Batch Code, Grade
- Rated in Metric Ton(s)

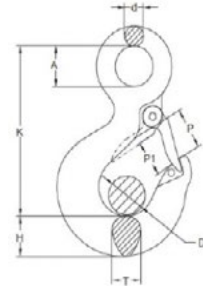

WLL (t)	Latch Kits		Dimensions (in)								Wt./ea. (lb)	Price / ea.	Part Number
	Price/ea.	Part Number	A	D	d	H	K	P	P1	T			
2	22.63	28-2TLK	1.14	0.79	0.51	1.02	4.17	1.10	0.79	0.83	1.5	40.23	28-2TEHH
3	22.63	28-3TLK	1.26	0.98	0.59	1.14	4.80	1.22	0.98	0.95	2.0	56.21	28-3TEHH
5	31.46	28-5TLK	1.57	1.22	0.71	1.46	5.87	1.45	1.22	1.22	4.4	106.57	28-5TEHH
7	50.29	28-7TLK	2.00	1.54	0.95	1.85	7.56	1.81	1.54	1.46	8.8	196.21	28-7TEHH

HOOK - SWIVEL, HOIST, GRADE 100, YOKE® BRAND

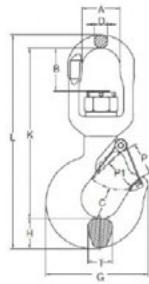

- Material: Alloy Steel, Grade 100
- Standard: EN 1677-5 / ASTM A952/952M
- Finish: Powder Coated, Blue
- Design Factor: 5:1
- Identification: Trademark, Size/WLL, Batch Code, Grade
- Rated in Metric Ton(s)

WLL (t)	Latch Kits		Dimensions (in)											Wt./ea. (lb)	Price / ea.	Part Number
	Price/ea.	Part #	A	B	C	D	G	H	K	L	P	P1	T			
3	22.63	28-3TLK	1.62	1.38	1.16	0.63	4.02	1.13	7.73	8.36	1.22	0.98	0.95	3.3	150.13	28-3TSWLHH
5	31.46	28-5TLK	1.83	1.73	1.53	0.83	5.14	1.41	8.32	10.58	1.42	1.22	1.22	7.0	228.22	28-5TSWLHH
22	96.63	28-22TLK	4.83	4.55	2.81	1.64	10.91	3.00	18.42	23.58	3.39	3.19	2.69	73.5	2,620.83	28-22TSWLHH
30	124.25	28-30TLK	4.83	4.24	3.44	1.64	13.90	3.60	19.67	25.63	3.50	3.27	3.00	101	4,186.43	28-30TSWLHH



What makes the Sea Catch so revolutionary?

The Sea Catch Toggle Release is the simplest and most innovative design in quick release history. It is a device designed exclusively for safe release of a line or object under load.

Its multi-purpose design offers a combination of features never seen before in a quick release: multi directional releasing capabilities, on-load and off-load releasing, a hitch pin safety lock to prevent inadvertent release, lanyard-style release for maximum user safety, parts made from aerospace-grade stainless plate, easy connection to common shackles, no springs, and a user friendly size.

The design anticipates reality: heavy sea conditions, corrosive marine environments, quick release kickback, inadvertent release, and the occasional shock and lock ups of unanticipated overload. The key to its success is the combination of a proven toggle linkage principal, low

friction, computer generated parts, and a lot of thinking about its many uses and applications.

Quick releases have to be specific. Movie special effects, tug-tow operations, rescue launch deployment, anchors – each release poses a very different challenge. Sea Catch meets these challenges with models ranging from 1 to 600 ton capacities. Since 1994, Sea Catches have played significant roles in safe releasing operations in 14 major industries around the world. Some units have exceeded 5,000 cycles and are still in service. All feedback has been positive, nothing but praise from engineers and users worldwide.

Releasing an object under load need not be a daunting task any longer. Release yourself of unnecessary hazards.

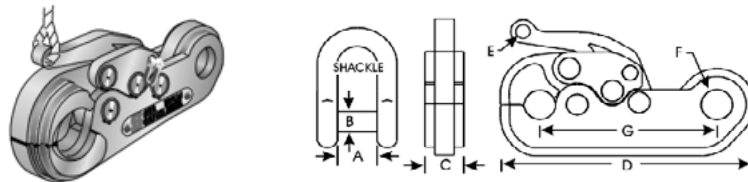

Model No.	Shackle Size (in)	Dimensions (in)							WLL (lb)	Break Load (lb)	Weight / ea. (lb)
		A	B	C	D	E	F	G			
TR3	1/4	0.47	0.31	0.41	2.85	0.18	0.37	1.96	1302	6510	0.31
TR5	7/16	0.75	0.50	0.69	4.50	0.25	0.55	3.13	3323	16 618	1.3
TR7	5/8	1.06	0.75	1.00	6.62	0.38	0.81	4.56	7042	35 210	4
TR8	3/4	1.25	0.87	1.19	7.68	0.43	0.93	5.53	9574	47 870	6.3
TR10	1	1.69	1.13	1.63	9.75	0.56	1.21	6.87	15 840	79 200	12.5
TR11	1 3/8	2.25	1.50	2.12	13.15	0.75	1.63	9.15	28 000	140 000	32
TR12	1 1/2	2.38	1.62	2.25	14.25	0.81	1.78	9.92	32 860	164300	40
TR15	1 3/4	2.88	2	2.75	17.56	1	2.16	12.21	50 200	251 000	69
TR16	2	3.25	2.25	3.13	19.73	1.12	2.46	13.75	63 380	316 900	108
TR17	2 1/2	4.15	2.75	3.88	24.13	1.37	3.01	16.81	94 740	473 700	197
TR18	3	5	3.25	4.75	30.79	1.75	3.85	21.43	154 240	771 200	360

HOOKS EYE HOIST - WARNINGS AND APPLICATION INSTRUCTIONS

Operating Practices:

Personnel using hooks shall be aware of the following:

- Never use a hook with a throat opening that has been increased, or with a tip that has been bent out of plane from the hook body. A latch will not work properly on a hook that has been worn or bent.
- Any hook that has a crack, nick, or gouge must be removed from service.
- Never repair, alter, re-work, or re-shape a hook by welding, heating, burning or bending.
- Do not swivel hooks under load.
- It shall be determined that the load to be applied does not exceed the lesser of the load rating of the hook or the load rating of the equipment of which the hook is a part.
- Shack loading shall be avoided.
- Load shall be centered in the base (bowl/saddle) of the hook to prevent point loading of the hook.
- When multileg slings are placed in the base (bowl/saddle) of the hook, the maximum included angle between sling legs shall be 90 deg or as determined by the hook manufacturer. The maximum sling leg angle with respect to the hook centerline for any rigging arrangement shall be 45 deg.
- A collector ring, such as a link or shackle, should be used when more than two legs are placed in a hook for angles greater than 45 deg with respect to the hook centerline.
- Hooks shall not be used in such a manner as to place a side load, back load, or tip load on the hook.
- When using a device to close the throat opening of the hook, care shall be taken that the load is not carried by the closing device.
- Hands, fingers, and body shall be kept from between hook and load.
- The use of the hook with latches does not preclude the inadvertent detachment of a slack sling or a load from the hook. Hook latches aid in the retention of loose slings under slack rigging conditions only and are not intended to be antifouling devices during load handling or rigging. Visual verification of proper hook engagement is required in all cases.
- Self-Locking hooks shall be locked during use.
- When a latch is equipped with a lock open device to facilitate rigging, the latch shall be closed during operation.
- When a hook is equipped with a latch, the load shall not restrict the closure of the latch.
- The need for a latch or mousing on any hook is a function of the application of the hook and shall be determined by a qualified person.

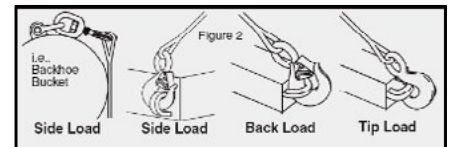
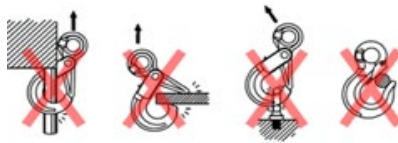
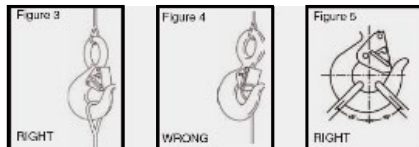

NEVER side load, back load or tip load!

- Loads may disengage from hook if proper procedures are not followed
- A falling load can cause serious injury or death
- Not for personnel lifting
- The hook must always support the load, the load must never be supported by the latch
- Never exceed the hooks working load limit (WLL)
- Perform periodic visual inspection by trained personnel in compliance with the schedule in ANSI B30.10



OCEAN BRAND
PLAIN TROLLEY
2 Ton
S/No: 09570875 Date: 10/2017
CE

OCEAN BRAND
CHAIN HOIST
1.5 TON
S/No: 205192 Date: 03/2022
CE

HOISTS & LIFTING ACCESSORIES

Manual Chain Blocks & Lever Pullers 128 - 143
Wire Rope Winches 144
Permanent Magnet Lifters 145 - 146
Trolleys & Beam Clamps 147 - 148
Vertical & Horizontal Plate Clamps 149 - 150
Cable Socks & Synthetic Rope Grabs 150 - 151
Concrete Lifters 152
Drum Lifters 153





PRINCIPLE OF OVERLOAD PROTECTION

The principle of overload protection brake engagement is the same on both lever pullers and chain blocks. The unit has an adjustable friction disk when engaged produces a friction force between the disk and the hand wheel or lever. This is adjusted at the factory. Each unit is tested twice. The first is a normal proof load test, and the second load is used to set the friction disk brake engagement. For example on a 1.5 ton lever block, the block is pulled to 1.5 times the WLL, $1.5 \text{ ton} \times 1.5 = 2.25 \text{ ton}$ as a normal proof load test. The block is then taken to 1.3 times the WLL to set the friction brake. $1.5 \text{ ton} \times 1.3 = 1.95 \text{ ton}$. If the unit is taken above this load the friction disk will engage and the unit will not lift. Proof loading for this block would be $1.25 \times 1.5 \text{ ton} = 1.875 \text{ ton}$.

- Standard lift from stock 3 & 6 meter - "custom chain length available on request"
- Standard: EN 13157, ASME B30.16
- Identification: Trademark, Size/WLL, Date, Serial No.
- Finish: Painted Yellow



BLOCK - CHAIN HOIST, 619, OCEAN® BRAND®

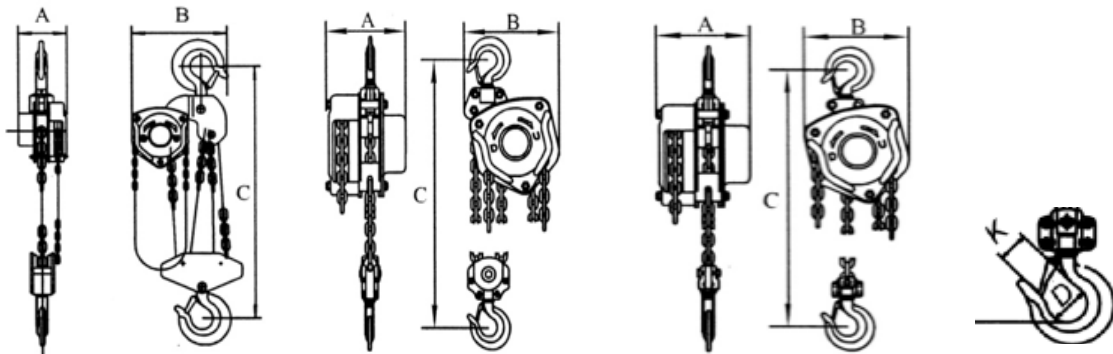

WLL (t)		0.5	1	1.5	2	3	5	10	20
Part Number		6-0.5TCB3	6-1TCB3	6-1.5TCB3	6-2TCB3	6-3TCB3	6-5TCB3	6-10TCB3	N/A
Price 3 m (10 ft) of Lift	ea.	262.55	313.10	466.46	482.10	598.29	790.05	1,581.96	-
Part Number		6-0.5TCB6	6-1TCB6	6-1.5TCB6	6-2TCB6	6-3TCB6	6-5TCB6	6-10TCB6	6-20TCB6
Price 6 m (20 ft) of Lift	ea.	357.66	423.15	572.00	591.29	792.30	1,144.75	2,105.25	5,271.00
Number of falls		1	1	1	1	2	2	4	8
Dimensions (mm)	A	131	140	161	161	161	186	207	209
	B	127	158	174	187	199	253	398	625
	C	270	317	399	414	465	636	798	890
	D	35	35.5	45	42.5	50	64	85	110
	K	30	28	36	33.5	40	50	64	81
Net Weight / 3 m of lift	kg	10	12	19	20	27	45.5	83	173
Running test load	Kn	7.5	15	22.5	30	45	75	150	235.2
Effort to lift rated load	N	231	309	320	360	340	414	414	435X2
Load chain diameter	mm	6	6	8	8	8	10	10	10
Chain weight kg/m	kg	1.7	1.7	2.3	2.3	3.7	5.6	9.7	19.4

Rated in Metric Ton(s)

WARNING - Read and understand all warnings, maintenance, and operation instructions (supplied with every unit).

NON-OVERLOAD PROTECTION

- Marking: Rated load, Direction of motion, Name of Manufacturer, Manufacturer's model or serial number. Product safety/warning information
- Standard lift from stock 6 meter - "custom chain length available on request"
- Standard: EN 13157, ASME B30.16
- Finish: Painted Orange
- Identification: Trademark, Size/WLL, Date, Serial No.
- Rated in Metric Ton(s)

BLOCK - CHAIN HOIST, 619, OCEAN® BRAND® (NOP)

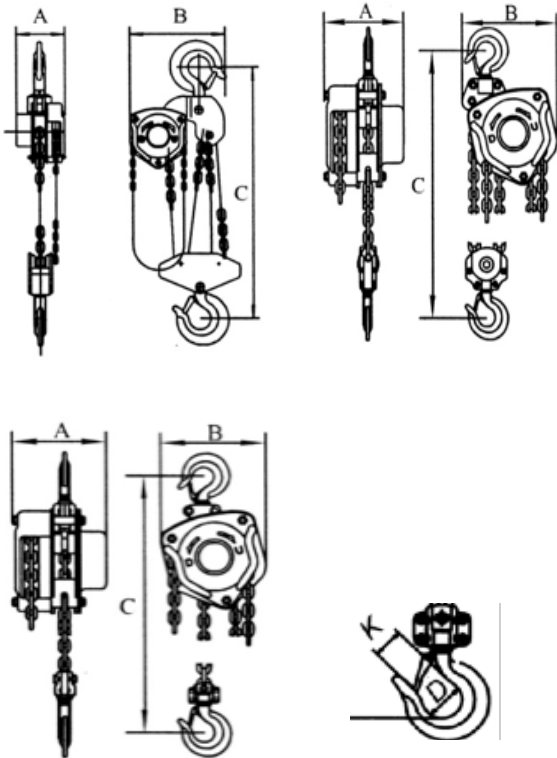

WLL (t)		1	1.5	2	3
Part Number		6-1TCB6-NOP	6-1.5TCB6-NOP	6-2TCB6-NOP	6-3TCB6-NOP
Price 6 m (20 ft) of Lift	ea.	375.15	467.50	521.97	716.15
Number of falls		1	1	1	2
Dimensions (mm)	A	140	161	161	161
	B	158	174	187	199
	C	317	399	414	465
	D	35.5	45	42.5	50
	K	28	36	33.5	40
Net Weight / 6 m of lift	kg	17	26	27	41
Running test load	Kn	15	22.5	30	45
Effort to lift rated load	N	309	320	360	340
Load chain diameter	mm	6	8	8	8
Chain weight kg/m	kg	1.7	2.3	2.3	4.6

WARNING - Read and understand all warnings, maintenance, and operation instructions (supplied with every unit).



CHAIN HOIST PARTS BREAKDOWN

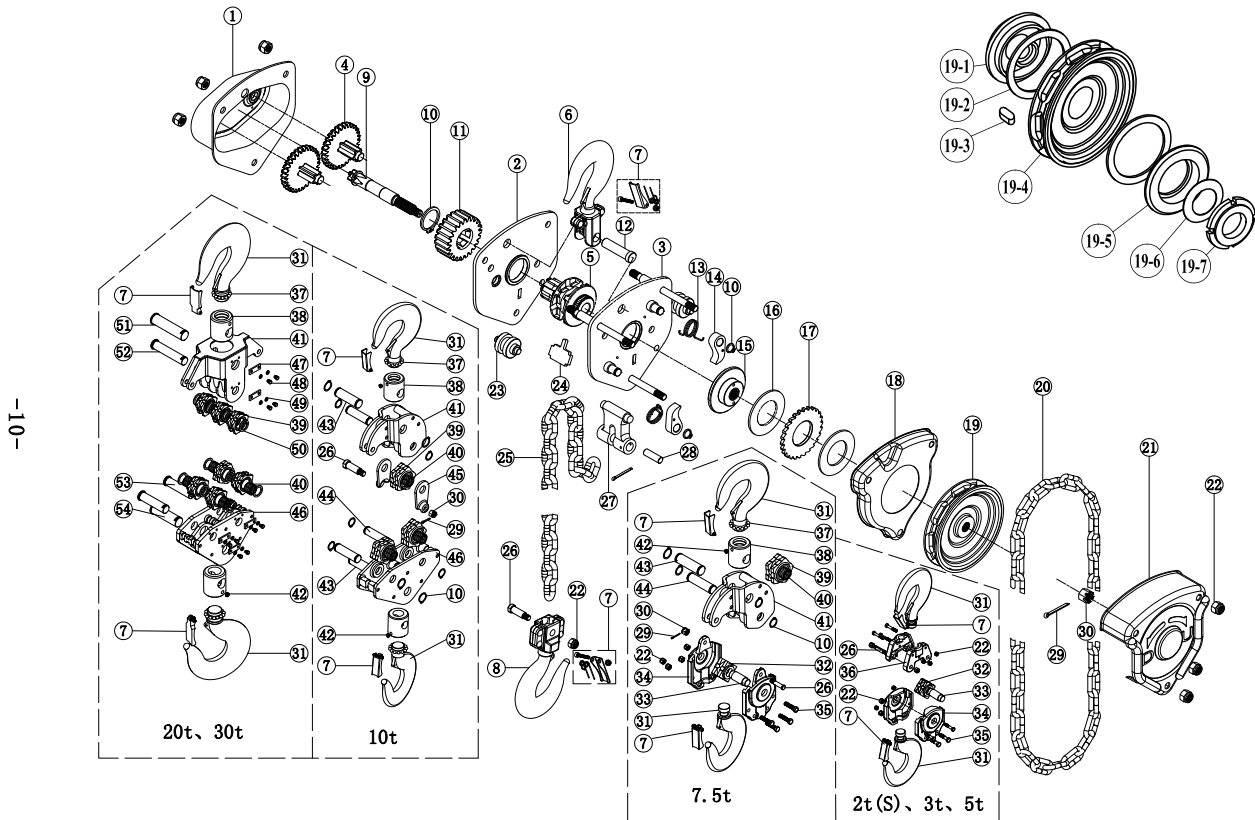

Top and Bottom hook assembly sold as complete kit only

#	Description	#	Description	#	Description	#	Description
1	Bent plate	13	Hook pin	25	Pawl	37	Move wheel
2	End anchor pin	14	Hand chain	26	Spring ring	38	Move wheel pin
3	End anchor	15	Disk gear	27	Ratchet disk	39	Bottom hook frame
4	Chain pin	16	Driving shaft	28	Friction plate	40	Row
5	Load chain (sold/ft)	17	Splined gear	29	Brake cover	41	Hook frame bar
6	Stripper	18	Steel bushing	30	Hand wheel	42	Lock screw
7	Bottom hook as.	19	Right side plate	31	Cotter pin	43	Top hook pin
8	Safe clip	20	Guide roller	32	Hand wheel cover	44	Bunton
9	Bearing race	21	Roller	33	Hook	45	Screw
10	Left side plate	22	Load sheave	34	Spring	46	Stripper
11	Stay	23	Top hook assembly	35	Rivet	47	Sling plate
12	Brake seat	24	Double spring	36	Top hook frame	48	Bottom hook pin

AVAILABLE SPARE PARTS FOR CHAIN HOIST BLOCK 619

#	Description	1/2 t		1 t		1-1/2 t	
2	End anchor pin	1.75	6-0.5TCBEAP	2.44	6-1TCBEAP	2.93	6-1.5TCBEAP
4	Chain pin	10.90	6-0.5TCBCP	11.51	6-1TCBCP	14.43	6-1.5TCBCP
5	Load chain (\$/ft)	14.86	6-0.5-1TCBCH			22.10	6-1.5T-3TCBCH
7	Bottom hook as.	57.51	6-0.5TCBBHA	59.65	6-1TCBBHA	70.02	6-1.5TCBBHA
8	Safe clip	7.99	6-0.5TCBSC	7.99	6-1TCBSC	9.09	6-1.5TCBSC
13	Hook pin	10.07	6-0.5TCBHP	10.07	6-1TCBHP	14.43	6-1.5TCBHP
14	Hand chain	6.18	6-HAND CHAIN				
22	Load sheave	53.60	6-0.5&1TLS			70.05	6-1.5&2TLS
23	Top hook assem.	45.76	6-0.5TCBTHA	54.23	6-1TCBTHA	67.77	6-1.5TCBTHA
24	Double spring	3.42	6-0.5TCBDS	3.50	6-1TCBDS	4.40	6-1.5TCBDS
25	Pawl	8.67	6-0.5TCBP	8.69	6-1TCBP	14.43	6-1.5TCBP
26	Spring ring	2.96	6-0.5TCBSR	4.40	6-1TCBSR	5.76	6-1.5TCBSR
28	Friction plate	14.39	6-0.5TCBFP	14.43	6-1TCBFP	18.07	6-1.5TCBFP
31	Cotter pin	1.94	6-0.5TCBCP31	2.44	6-1TCBCP31	2.93	6-1.5TCBCP31

#	Description	2 t		3 t		5 t		10 t	
2	End anchor pin	2.93	6-2TCBEAP	4.29	6-3TCBEAP	4.29	6-5TCBEAP	4.29	6-5TCBEAP
4	Chain pin	14.43	6-2TCBCP	14.43	6-3TCBCP	14.43	6-5TCBCP	14.43	6-5TCBCP
5	Load chain (\$/ft)	22.10	6-1.5T-3TCBCH			42.81	6-5T-10TCBCH		
7	Bottom hook as.	90.01	6-2TCBBHA	128.03	6-3TCBBHA	215.65	6-5TCBBHA	506.42	6-10TCBBHA
8	Safe clip	14.43	6-2TCBSC	10.16	6-3TCBSC	12.70	6-5TCBSC	21.89	6-10TCBSC
13	Hook pin	14.43	6-2TCBHP	17.36	6-3TCBHP	28.84	6-5TCBHP	28.84	6-5TCBHP
14	Hand chain	7.32	6-HAND CHAIN						
22	Load sheave	70.05	6-1.5&2TLS			91.64	6-3&5TLS		
23	Top hook assem.	81.75	6-2TCBTHA	106.79	6-3TCBTHA	205.72	6-5TCBTHA	453.29	6-10TCBTHA
24	Double spring	4.40	6-2TCBDS	4.67	6-3TCBDS	4.67	6-5TCBDS	4.67	6-5TCBDS
25	Pawl	14.43	6-2TCBP	17.30	6-3TCBP	17.30	6-5TCBP	17.30	6-5TCBP
26	Spring ring	5.76	6-2TCBSR	5.76	6-3TCBSR	8.70	6-5TCBSR	8.70	6-5TCBSR
28	Friction plate	18.07	6-2TCBFP	21.89	6-3TCBFP	21.89	6-5TCBFP	21.89	6-5TCBFP
31	Cotter pin	2.93	6-2TCBCP31	3.91	6-3TCBCP31	3.91	6-5TCBCP31	3.91	6-5TCBCP31

Rated in Metric Ton(s)

The Subsea Lever Hoist is our premium line hoist with the following advantages:

- The driving shaft is fixed by a simple support structure. The gear transmission is more stable and effective.
- The hand wheel is steel with higher strength and reliable operation. No preload required.
- The surface treatment of change over gear, brake seat, brake steel bushing and fused brake disc are Cr-free Dacromet (better corrosion resistance).
- Fused brake disc is a whole part and includes friction disk and ratchet. This provides exceptional performance and long life.
- The performance of our maintenance free bearing is close to rolling bearing with better corrosion resistance.
- The hooks are alloy steel and passed heat treatment.
- Compact and higher strength lever is suited for narrow space operation. The material of handle and sleeve is special elastomer.
- Higher strength and higher temperature resistance. Grade 80 load chain comes with Cr-free Dacromet finish. Brake seat and driving shaft are connected by involute splines, brake effect is higher and the parts are easily disassembled.
- Standard parts made of stainless steel.

LEVER HOIST - PULLER, 816, OCEAN® BRAND®, SUBSEA

- Patented
- Standard: EN 13157, ASME B30.21
- Finish: Painted White
- Identification: Trademark, Size/WLL, Date, Serial No.
- Rated in Metric Ton(s)



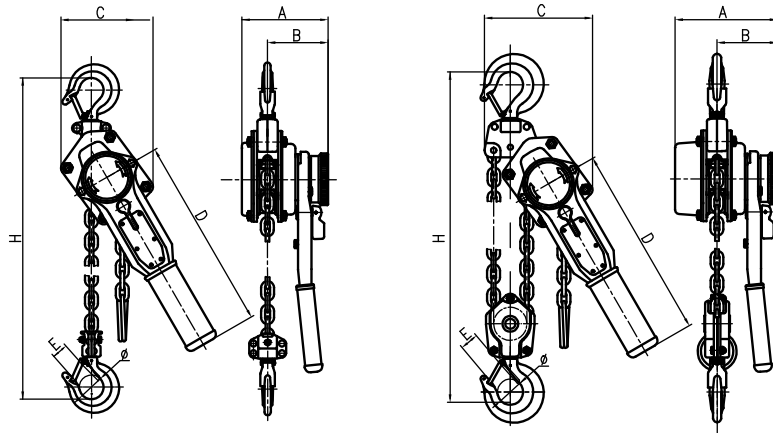

WLL (t)		L3-1.5	L3-3	L3-6
Capacity	kg	1500	3000	6000
Part Number		6-1.5TSS-L3LP	6-3TSS-L3LP	6-6TSS-L3LP
Price		1,076.00	1,577.99	2,654.20
Lift	m	1.5	1.5	1.5
Test Load	kg	1875	3750	7500
Pull on lever to lift full load	N	295	380	390
No. of load chain falls		1	1	2
Diameter of load chain	mm	7 x 21	10 x 30	10 x 30
Min. distance between hooks	mm	400	460	600
Length of lever handle	mm	378	418	418
Dimensions mm	A	173	204	204
	B	99	114	114
	C	145	203	243
	Φ	42.5	55	65
	E	2.9	40	46
Net weight	kg	10.9	20.5	32

WARNING - Read and understand all warnings, maintenance, and operation instructions (supplied with every unit).

LIGHT WEIGHT ALUMINUM LEVER HOIST

The Light Weight Aluminum Lever Hoist is one of our premium line hoist with the following advantages:

- Aluminum Material, Light weight. Load chain sprocket made of heat treated alloy steel with precision machining. Chain guides provide smooth chain operation. Rubber grips used to prevent hand sliding during operation. Double regulating wheel structure and double pawl guarantee safe and reliable brake operation. Suitable for high altitude and small space operation. The existing brake separation technology can be quickly adjusted to a suitable working position. The hooks are alloy steel, heat treated and includes cast safety latch. Grade 80 load chain is accorded with EN818-7 standard. No overload protection.

LEVER HOIST - PULLER, HSH-AL, OCEAN® BRAND®, LIGHT WEIGHT ALUMINUM

- Patented
- Standard: EN 13157, ASME B30.21
- Finish: Aluminum
- Identification: Trademark, Size/WLL, Date, Serial No.
- Rated in Metric Ton(s)
- Standard lift from stock, "custom chain length available on request"

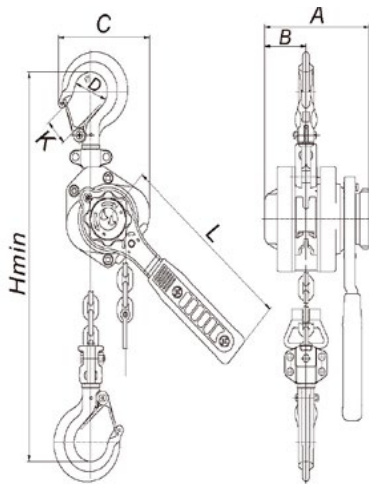

WLL (t)		0.25	0.5	0.75	1.5
Part Number		6-0.25TLPAL	6-0.5TLPAL	6-0.75TLPAL	6-1.5TLPAL
Price	ea.	254.75	269.20	430.29	511.75
Standard lift	m	1	1	1.5	1.5
Strands of load chain		1	1	1	1
Dimensions (mm)	A	94.5	100	126	142
	B	35	39	50	63.5
	C	84	99	110	133
	D	34	34	40	45
	H min	230	265	315	340
	L	163	163	208	238
	K	24	24	26	31
Net Weight per standard lift	kg	1.9	2.7	4.8	7
Running test load	kN	3.1	6.1	9.2	18.4
Force to lift rated load	N (kg)	206 (21)	255 (26)	303 (31)	362 (37)
Load chain diameter	mm	4	5	5.6	7.1
Chain weight kg/m	kg/m	0.36	0.55	0.68	1.2
Load Chain Part Number.		6-4X12LCH	6-5X15LCH	6-5.6X15.6LCH	6-7.1X19.9LCH
Price	ft.	22.40	17.48	17.48	27.85
Top Hook Assembly Part Number		6-0.25TTHA	6-0.5TTHA	6-0.75TTHA	6-1.5TTHA
Price	ea.	24.08	27.61	40.66	51.61
Bottom Hook Assembly Part Number		6-0.25TBHA	6-0.5TBHA	6-0.75TBHA	6-1.5TBHA
Price	ea.	26.07	31.27	46.90	55.26
Latch Kits Part Number		6-0.25TLK	6-0.5TLK	6-0.75TLK	6-1.5TLK
Price	ea.	3.65	3.65	4.17	5.21
Friction Disk Part Number		6-0.25TFDAL	6-0.5TFDAL	6-0.75TFDAL	6-1.5TFDAL
Price	ea.	9.39	9.39	10.42	10.42

PRINCIPLE OF OVERLOAD PROTECTION



The principle of overload protection brake engagement is the same on both lever pullers and chain blocks. The unit has an adjustable friction disk when engaged produces a friction force between the disk and the hand wheel or lever. This is adjusted at the factory. Each unit is tested twice. The first is a normal proof load test, and the second load is used to set the friction disk brake engagement. For example on a 1.5 ton lever block, the block is pulled to 1.5 times the WLL, $1.5 \text{ ton} \times 1.5 = 2.25 \text{ ton}$ as a normal proof load test. The block is then taken to 1.3 times the WLL to set the friction brake. $1.5 \text{ ton} \times 1.3 = 1.95 \text{ ton}$. If the unit is taken above this load the friction disk will engage and the unit will not lift. Proof loading for this block would be $1.25 \times 1.5 \text{ ton} = 1.875 \text{ ton}$.

- Standard lift from stock - 1.5 & 3 meter - "custom chain length available on request".



LEVER HOIST - PULLER, 622, OCEAN® BRAND®

- **Patented**
- Standard: EN 13157, ASME B30.21
- Finish: Painted Yellow
- Identification: Trademark, Size/WLL, Date, Serial No.
- Rated in Metric Ton(s)

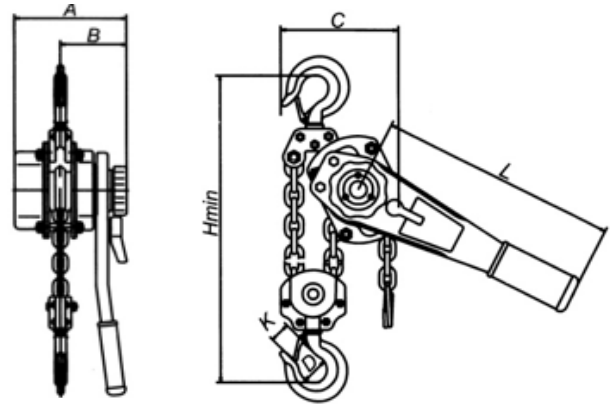

WLL (t)		0.75	1.5	3	6	9
Part Number		6-0.75TLP	6-1.5TLP	6-3TLP	6-6TLP	6-9TLP
Price (1.5 m of Lift)	ea.	313.50	381.99	627.00	1,093.30	1,561.40
Part Number		6-0.75TLP3	6-1.5TLP3	6-3TLP3	-	-
Price (3 m of Lift)	ea.	336.00	417.35	768.92	-	-
Strands of load chain		1	1	1	2	3
Dimensions (mm)	A	148	172	200	200	200
	B	90	98	115	115	115
	C	136	160	180	235	320
	H	325	380	480	620	700
	L	280	410	410	410	410
	K	34	38	48	52	58
Net Weight / 3 m of lift	kg	7	11	21	31	46
Running test load	Kn	11.0	22.0	37.5	75.0	112.5
Force to lift rated load	N	140	220	320	340	360
Load chain diameter	mm	6	8	10	10	10
Chain weight kg/m	kg	0.8	1.4	2.2	4.4	6.6

WARNING - Read and understand all warnings, maintenance, and operation instructions (supplied with every unit).

NON-OVERLOAD PROTECTION

- Marking: Rated load, Direction of motion, Name of Manufacturer, Manufacturer's model or serial number. Product safety/warning information
- Standard lift from stock - 3 meter - "custom chain length available on request"
- Lever Puller rated in Metric Ton = Tons of 1000kgs. (2200 pounds / 9.81kN)



LEVER HOIST - PULLER, 622, OCEAN® BRAND® (NOP)

- **Patented**
- Standard: EN 13157, ASME B30.21
- Finish: Painted Orange
- Identification: Trademark, Size/WLL, Date, Serial No.
- Rated in Metric Ton(s)

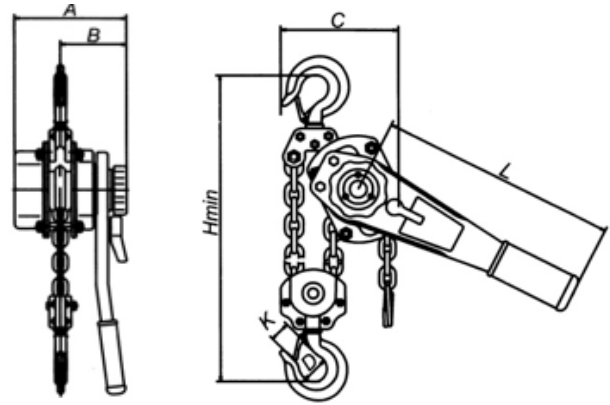

WLL (t)		0.75	1.5	3	6
Part Number		6-0.75TLP3-NOP	6-1.5TLP3-NOP	6-3TLP3-NOP	6-6TLP3-NOP
Price	ea.	305.45	360.95	562.80	993.95
Standard lift	m	3	3	3	1.5
Strands of load chain		1	1	1	2
Dimensions (mm)	A	148	172	200	200
	B	90	98	115	115
	C	136	160	180	235
	H	325	380	480	620
	L	280	410	410	410
	K	34	38	48	52
Net Weight / 3 m of lift	kg	7	11	21	31
Running test load	kN	11.0	22.0	37.5	75.0
Force to lift rated load	N	140	220	320	340
Load chain diameter	mm	6	8	10	10
Chain weight kg/m	kg	0.8	1.4	2.2	4.4

WARNING - Read and understand all warnings, maintenance, and operation instructions (supplied with every unit).

LEVER HOIST PARTS BREAKDOWN

#	Description	#	Description	#	Description	#	Description	#	Description
1	Gear assembly	14	Snap ring	27	Hand wheel	40	Castle nut	53	6t top hook frame
2	Disk gear assy.	15	Disk hub	28	Hex nut	41	Split pin	54	Move wheel pin
3	Drive shaft	16	Free spring	29	Chain ring	42	Lock nut	55	Move wheel
4	Splined gear	17	Friction disk	30	Name plate	43	Wire snap ring	56	6t bottom hook frame
5	Gear side plate assy.	18	Ratchet disk	31	Top hook assy.	44	Screw	57	Nut
6	Load sheave	19	Female thread grip	32	Top hook shaft	45	Lock washer	58	Screw
7	Guide plate	20	Brake cover assy.	33	Bottom hook assy.	46	Rivet	59	Nut
8	Roller	21	Change over gear	34	Chain pin	47	Snap ring	60	Screw
9	Bearing race	22	Lever handle assy.	35	Load chain	48	6t hook	61	Safe clip assembly
10	Stripper	23	Change over pawl	36	Lock washer	49	Nut		
11	Lever side plate assy.	24	Spring seat	37	Hex nut	50	Screw		
12	Pawl spring	25	Change over spring	38	Lock washer	51	6t pin		
13	Pawl	26	Bushing	39	Screw	52	Nut		

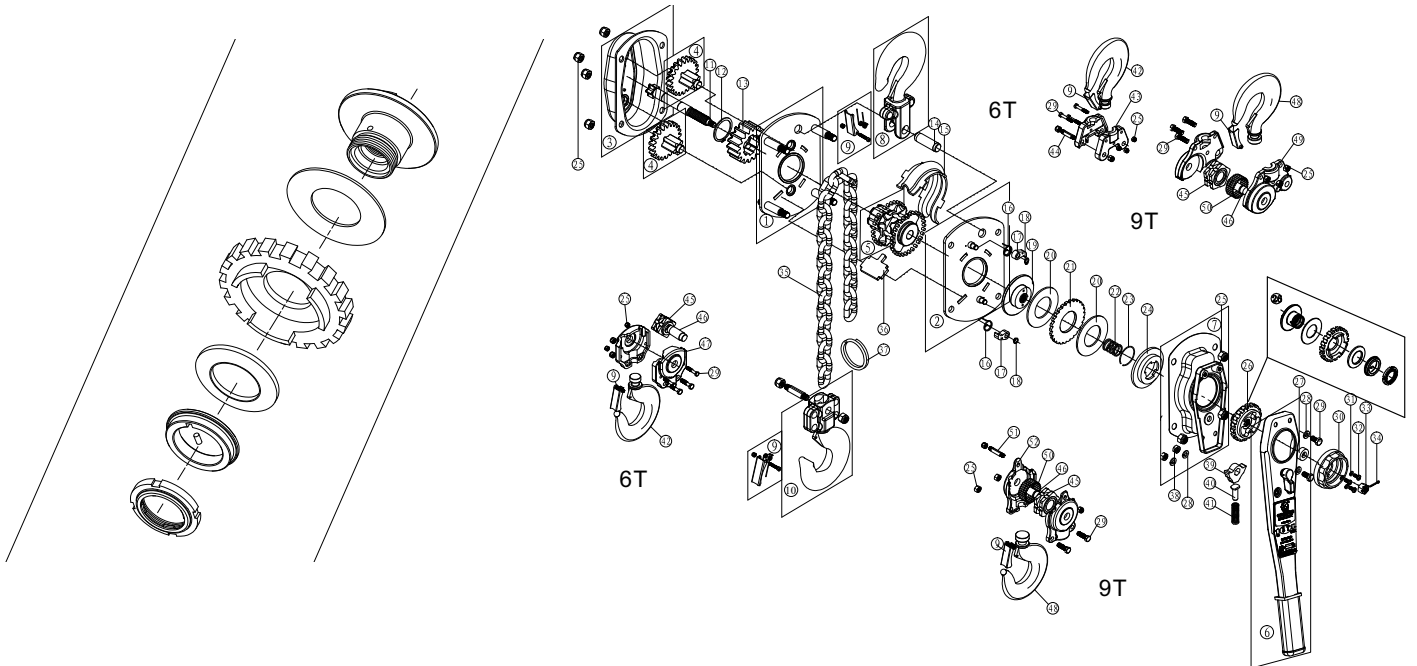

Available Spare Parts for Lever Hoist

#	Description	3/4 tonne		1-1/2 tonne		3 tonne		6 tonne	
6	Load sheave	45.34	6-0.75TLBLS	67.02	6-1.5TLBLS	128.56	6-3-6TLBLS	128.56	6-3-6TLBLS
12	Pawl spring	8.60	6-0.75TLBPS	10.90	6-1.5TLBPS	21.69	6-3TLBPS	21.69	6-3TLBPS
13	Pawl	11.25	6-0.75TPAWL	22.47	6-1.5TPAWL	28.14	6-3TPAWL	28.14	6-6TPAWL
14	Snap ring	2.93	6-0.75TLBSR	3.71	6-1.5TLBSR	5.47	6-3TLBSR	5.47	6-3TLBSR
16	Free spring	14.37	6-0.75TLBFS	22.98	6-1.5TLBFS	28.72	6-3TLBFS	28.72	6-3TLBFS
17	Friction disk	10.55	6-0.75TFD	17.59	6-1.5TFD	28.14	6-3TFD	28.14	6-6TFD
19	Female thread grip	25.98	6-0.75TLBFTG	32.43	6-1.5TLBFTG	43.25	6-3TLBFTG	43.25	6-3TLBFTG
20	Brake cover assembly	44.35	6-0.75TLBBCA	82.26	6-1.5TLBBCA	90.85	6-3TLBBCA	90.85	6-3TLBBCA
23	Change over pawl	15.14	6-0.75TLBCOP	21.48	6-1.5TLBCOP	32.43	6-3TLBCOP	32.43	6-3TLBCOP
24	Spring seat	6.54	6-0.75TLBSS	10.75	6-1.5TLBSS	10.75	6-3TLBSS	10.75	6-3TLBSS
25	Change over spring	6.45	6-0.75TLBCOS	10.75	6-1.5TLBCOS	10.75	6-3TLBCOS	10.75	6-3TLBCOS
26	Bushing	4.29	6-0.75TLBB	6.43	6-1.5TLBB	8.60	6-3TLBB	8.60	6-3TLBB
28	Hex Nut	4.29	6-0.75TLBHN	5.18	6-1.5TLBHN	5.18	6-3TLBHN	5.18	6-3TLBHN
29	Chain ring	8.60	6-0.75TLBCR	17.19	6-1.5TLBCR	21.48	6-3TLBCR	21.48	6-3TLBCR
30	Name plate	8.60	6-0.75TLBNP	11.53	6-1.5TLBNP	14.43	6-3TLBNP	14.43	6-3TLBNP
31	Top hook assembly	50.39	6-0.75TLBTHA	61.56	6-1.5TLBTHA	116.06	6-3TLBTHA	283.69	6-6TLBTHA
32	Top hook shaft	14.43	6-0.75TLBTHS	22.98	6-1.5TLBTHS	34.58	6-3TLBTHS	34.58	6-3TLBTHS
33	Bottom hook assembly	55.15	6-0.75TLBBHA	84.94	6-1.5TLBBHA	115.90	6-3TLBBHA	280.77	6-6TLBBHA
34	Chain pin	8.60	6-0.75TLBCP	13.00	6-1.5TLBCP	17.30	6-3TLBCP	17.30	6-6TLBCP
35	Load Chain	14.86	6-0.5-1TCBCH	22.10	6-1.5T-3TCBCH	42.81	6-5T-10TCBCH	42.81	6-5T-10TCBCH
36	Lock washer	0.98	6-0.75TLBLW	1.47	6-1.5TLBLW	1.77	6-3TLBLW	1.77	6-3TLBLW
37	Hex nut	4.29	6-0.75TLBHNN	5.18	6-1.5TLBHNN	5.76	6-3TLBHNN	5.76	6-3TLBHNN
38	Lock washer	0.98	6-0.75TLBLW38	1.47	6-1.5TLBLW38	1.77	6-3TLBLW38	1.77	6-3TLBLW38
39	Screw	2.44	6-0.75TLBS	2.93	6-1.5TLBS	3.82	6-3TLBS	3.82	6-3TLBS
40	Castle nut	2.93	6-0.75TLBCN	5.76	6-1.5TLBCN	8.60	6-3TLBCN	8.60	6-3TLBCN
41	Split pin	1.47	6-0.75TLBSP	2.44	6-1.5TLBSP	2.93	6-3TLBSP	2.93	6-3TLBSP
42	Lock nut	1.47	6-0.75TLBLN	2.44	6-1.5TLBLN	2.93	6-3TLBLN	2.93	6-3TLBLN
43	Wire snap ring	5.70	6-0.75TWSR	5.70	6-1.5TWSR	6.88	6-3TWSR	6.88	6-3TWSR
44	Screw	5.70	6-0.75TLBSS44	5.70	6-1.5TLBSS44	5.70	6-3TLBSS44	5.70	6-3TLBSS44
45	Lock washer	0.98	6-0.75TLBLW45	1.47	6-1.5TLBLW45	3.65	6-3TLBLW45	3.65	6-3TLBLW45
46	Rivet	5.04	6-0.75TLBR	5.61	6-1.5TLBR	6.23	6-3TLBR	6.23	6-3TLBR
47	Snap ring	2.93	6-0.75TLBSR47	3.65	6-1.5TLBSR47	9.30	6-3TLBSR47	9.30	6-3TLBSR47
61	Safe clip assembly	8.79	6-0.75TSCA	11.32	6-1.5TSCA	14.07	6-3TSCA	14.07	6-6TSCA

WINCH - WIRE ROPE, SPARE PIN

- Each new unit comes with a Spare Shear Pin located in the handle of the winch.



For Size (t)	Spare Replacement Shear Pins	
	Price / ea.	Part Number
0.8	19.49	6-0.8T#16SAFETYBOLT
1.6	19.49	6-1.6T#16SAFETYBOLT
3.2	19.49	6-3.2T#16SAFETYBOLT

WINCH - WIRE ROPE

- **Complete with: wire, hook and handle.**
- Safe, reliable, and efficient, these units are suitable for many applications.
- One man operated, using a telescopic handle, they work in any position and over any height of lift.
- Can replace conventional winches and other hoists for many applications.
- Proof load to the WLL, and use only properly sized dry galvanized wire rope provided with units.
- Standard: EN 13157
- Identification: Trademark, Size/WLL, Date
- Rated in Metric Ton(s)



Capacity lifting (t)	Capacity pulling (t)	Rope dia. (mm)	Weight / each (kg)	Size (mm)	Drive Step	c/w std wire length (m)	Spare Replacement Handles		Price / ea.	Part Number
							Price / ea.	Part Number		
0.8	1.3	8	6	428 x 64 x 235	1	20 m	85.20	6-0.8TWRWHANDLE	599.00	6-0.8TWRW
1.6	2.6	11	12	545 x 97 x 286	1	20 m	146.45	6-1.6TWRWHANDLE	895.00	6-1.6TWRW
3.2	5.2	16	23	660 x 116 x 350	2	20 m	146.45	6-3.2TWRWHANDLE	1,450.00	6-3.2TWRW

WARNING - Read and understand all warnings, maintenance, and operation instructions (supplied with every unit).

PERMANENT MAGNET LIFTER

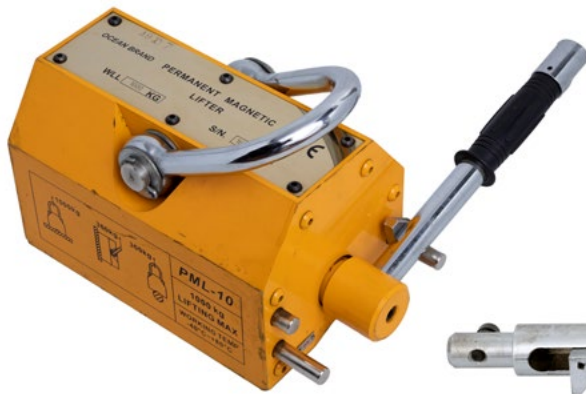

- Standard: EN 13155 & ASME B30.20
- Finish: Painted Yellow, Zinc
- Identification: Trademar, WLL, Serial No.
- Certification: Load Test

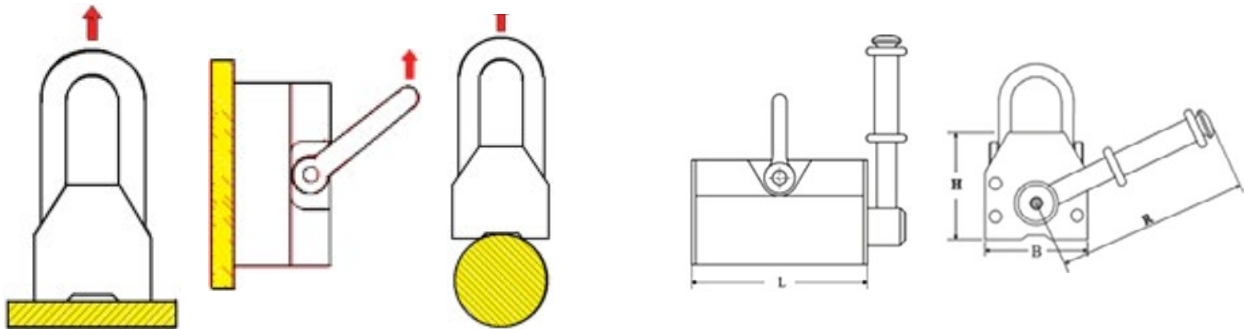

Horizontal Load Capacity (kg)	Horizontal [Max.] Break-away Force (kg)	Round Bar or Vertical Capacity (kg)	Dimensions (mm)					Wt. (kg)	Spare Handle Only		Spare Shackle Only		Magnet Lifter	
			L	B	H	R	Price / ea.		Part Number	Price / ea.	Part Number	Price / ea.	Part Number	
100	350	30	92	66	70	145	3	132.79	6-PML-01RH	115.56	6-PML-100RS	580.42	6-PML-100	
300	1050	100	165	88	96	176	10	137.32	6-PML-03RH	129.99	6-PML-300RS	1075.65	6-PML-300	
600	2100	200	236	118	120	219	23	169.24	6-PML-06 RH	158.96	6-PML-600RS	1853.00	6-PML-600	
1000	3500	300	264	172	168	285	54	253.98	6-PML-10RH	192.61	6-PML-1000RS	3333.45	6-PML-1000	
2000	7000	600	378	223	216	462	130	341.05	6-PML-20RH	260.06	6-PML-2000RS	7380.45	6-PML-2000	

- Do not use this lifting device above the working load limit for the application, this information is attached to each magnet.
- Operating temperature maximum 80°C.
- Other sizes available on request.

SEE WARNING AND APPLICATION INFORMATION - NEXT PAGE

PERMANENT MAGNET LIFTER - WARNINGS AND APPLICATION INSTRUCTIONS

Prior to operation, clear away rust and any debris from the components surface. The centerline of lifter must overlap with centerline of component then place the magnetic lifting hoist on the face of component, turn the handle from "OFF" to "ON" and confirm unit is holding. Make sure the security key on the handle is automatically locked, and then start to hoist for trial lift.

Air Gap – These lifting magnets create high magnetic forces which permit the magnet to clamp materials through the air gap but these air gaps do however decrease the magnetic performance due to the fact that they provide a barrier between the contact surfaces. Air gaps can happen in a variety of ways, such as dust, paint, and mill scale. Inadequately machined surfaces will also make up an air gap. The lifting magnet will need to be down rated in capacity according to the adhesive force / air gap as shown in the diagram below.

Material Thickness – When lifting magnets are used to lift materials which are thinner than the recommended minimum thickness, the clamping force of the magnet will be considerably lower. See below diagram for detailed information.

Full lifting capacity is only achieved when the lifting magnet has complete contact with the item being lifted. Performance will be affected if the surface of the materials to be lifted contains holes or is uneven. A trial lift must be carried out in these situations to establish correct lifting prior to transporting the load. Some materials will have differing abilities to carry magnetism. Apart from mild steel, a reduction factor needs to be applied so that the clamping force can be effectively calculated.

Model	Flat Material			Round Material			Tear off Force (kg)
	Maximum Capacity SWL (kg)	Min. Thickness (mm)	Max. Length of Material (mm)	Maximum Capacity SWL (kg)	Diameter (mm)	Max. Length of Material (mm)	
PML-100	100	30	2000	30	200-300	2 000	350
PML-300	300	40	2500	100	200-300	2 500	1050
PML-600	600	50	3000	200	200-400	3 000	2100
PML-1000	1000	60	3500	300	200-400	3 500	3500
PML-2000	2000	70	3500	600	200-400	3 500	7000

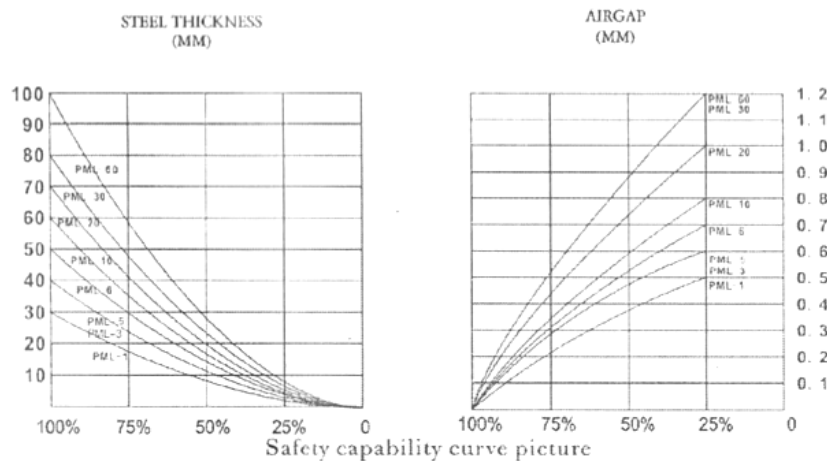

*** Read and understand Operating Instructions (supplied with every unit) before using this product ***

Reduction of capacity for material type	% of capacity
Temperature < 80°C	100%
Humidity < 80%	100%
Low Carbon Steel	100%
St 52	95%
Alloy Steel	80%
High Carbon Steel	70%
Cast Iron	45%
Nickel	45%
Austenitic Stainless Steel	0%
Brass	0%
Aluminium	0%

TROLLEYS - BEAM, PUSH TRAVEL

- For use on 'I' Beams
- Standard: EN 13157
- Identification: Trademark, Size/WLL, Date, Serial No.
- Rated in Metric Ton(s)

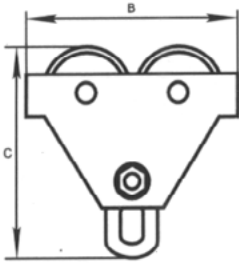
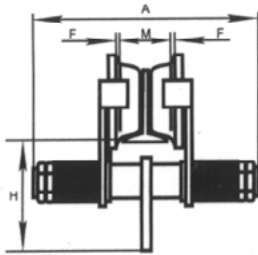

WLL (t)	I-Beam Width (mm)	Min. Radius Curve (m)	N.W. (kg)	A (mm)	B (mm)	C (mm)	H (mm)	Price / ea.	Part Number
0.5	64-140	0.6	7	230	212	198.5	113	157.45	6-0.5TT
1	64-140	0.8	12	254	255	231.5	128	249.45	6-1TT
1.5	76-165	1.1	18	276	277	265	145	308.95	6-1.5TT
2	76-165	1.1	22	294	302	278	152	379.60	6-2TT
3	76-203	1.4	30	344	344	338	186	575.40	6-3TT
5	88-203	1	55	360	378	393	219	966.29	6-5TT
10	125-203	1.3	93	403	455	490	275.5	1,529.86	6-10TT

CLAMP - BEAM

- For use on 'I' Beams
- Standard: EN 13157
- Identification: Trademark, Size/WLL, Date, Serial No.
- Rated in Metric Ton(s)

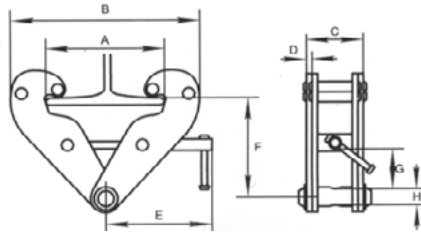

WLL (t)	Adj. Beam Width (mm)	N.W. / (kg)	Dimensions (mm)										Price / ea.	Part Number
			A Max.	B Min.	B Max.	C	D	E	F Min.	F Max.	G	H		
1	75-220	4	260	180	360	64	5	215	102	155	25	22	122.21	6-1TBC
2	75-220	5	260	180	360	74	6	215	102	155	25	22	144.84	6-2TBC
3	80-320	9	354	235	490	103	8	260	140	225	45	24	218.32	6-3TBC
5	80-320	11	354	235	490	110	10	260	140	225	45	28	228.97	6-5TBC
10	90-320	15	365	320	505	120	12	280	170	235	50	40	367.42	6-10TBC

WARNING

OVERLOADING AND IMPROPER USE CAN RESULT IN INJURY!

To avoid injury:

- DO NOT exceed working load limit, load rating or capacity
- DO NOT use to lift people, or loads over people
- Use only alloy chain and attachments for overhead lifting

PCD VERTICAL PLATE CLAMPS

PCD Plate clamp with safety lock

- Universal eye for lifting in any direction
- Standard: EN 13155
- Lock open, lock closed
- Equipped with a pre-tension mechanisms ensuring the clamp does not slip when lifting force is applied and when load is being lowered
- Tagged with manufacturer, capacity, date and serial number
- Rated in Metric Ton(s)
- Minimum W.L.L is 10% of the maximum W.L.L.

WLL (t)	Jaw Opening	Dimensions (mm)				N.W. / (kg)	Price / ea.	Part Number
		T	U	V	L			
1	0~20	300	50	145	66	5	308.64	6-1TPCD
2	0~25	385	68	175	75	8	436.65	6-2TPCD
3.2	0~30	430	75	215	102	15	643.00	6-3.2TPCD
5	0~50	500	68	232	112	23	693.00	6-5TPCD
8	0~45	600	88	290	125	37	On Request	6-8TPCD



Model	Jaw Opening (mm)	Load Capacity (kg)	T (mm)	U (mm)	V (mm)	L (mm)	Net Weight (kg)
PCD 0.5T	0~15	500	205	30	105	48	2
PCD 1T	0~20	1000	300	50	145	66	5
PCD 2T	0~25	2000	385	68	175	75	8
PCD 3.2T	0~30	3200	430	75	215	102	15
PCD 5T	0~50	5000	500	68	232	112	23
PCD 8T	0~45	8000	600	88	290	125	37
PCD 12T	50~90	12000	700	90	420	128	50
PCD 16T	60~100	16000	710	100	445	140	65
PCD 20T	0~80	20000	948	100	563	140	160
PCD 30T	10~90	30000	944	100	568	142	167

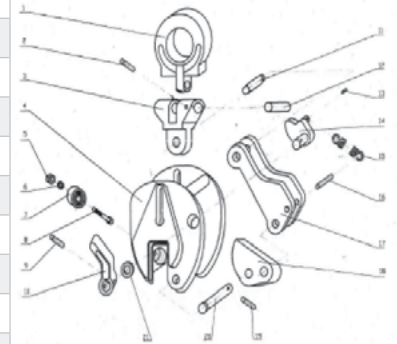

Part	1 tonne		2 tonne		3.2 tonne		5 tonne		8 tonne	
	Price / ea.	Part #	Price / ea.	Part #	Price / ea.	Part #	Price ea.	Part #	Price ea.	Part #
Pad Assembly # 5, 6, 7, 8	53.56	6-1TPCPA	59.48	6-2TPCPA	80.46	6-3.2TPCPA	86.67	6-5TPCPA	On Request	6-8TPCPA
Pivoting Shackle Pin # 12	29.73	6-1TPCPSP	39.60	6-2TPCPSP	49.46	6-3.2TPCPSP	57.75	6-5TPCPSP	On Request	6-8TPCPSP
Function Block # 14	15.84	6-1TPCFB	23.83	6-2TPCFB	29.73	6-3.2TPCFB	36.08	6-5TPCFB	On Request	6-8TPCFB
Pulling Spring # 15	9.94	6-1TPCPS	15.86	6-2TPCPS	19.80	6-3.2TPCPS	27.09	6-5TPCPS	On Request	6-8TPCPS
Roll Pin # 16	2.05	6-1TPCRIN	2.05	6-2TPCRIN	2.05	6-3.2TPCRIN	2.11	6-5TPCRIN	On Request	6-8TPCRIN
Connecting Plate & Jaw # 17, 18	99.07	6-1TPCJA	128.66	6-2TPCJA	213.67	6-3.2TPCJA	257.87	6-5TPCJA	On Request	6-8TPCJA
Roll Pin # 19	2.05	6-1TPCRP	2.05	6-2TPCRP	2.05	6-3.2TPCRP	2.11	6-5TPCRP	On Request	6-8TPCRP
Jaw Pin # 20	29.73	6-1TPCJP	39.60	6-2TPCJP	49.53	6-3.2TPCJP	57.76	6-5TPCJP	On Request	6-8TPCJP

INSPECTION, CARE & USE

- DO NOT lift loads less than 10% of working load limit of clamp
- DO NOT lift plates with a temperature greater than 100°C
- DO NOT use to lift stainless steel lead or copper

CLAMP - PLATE, HORIZONTAL LIFTING CLAMP

- Intended to be used in pairs, sets of pairs, or in a tripod arrangement for transporting steel plate horizontally
- For handling inherently stacked nundles of sheets and steel plates
- Fastened to suitable slings and attached at three or more points on the load being handled
- Larger jaw opening
- With long load, we recommend using a spreader beam
- Able with latch handle for pretension on material and then release on material
- Standard: EN 13155
- Finish: Painted Blue
- Identification: Trademark, Size/WLL, Serial No, Date
- Rated in Metric Ton(s)

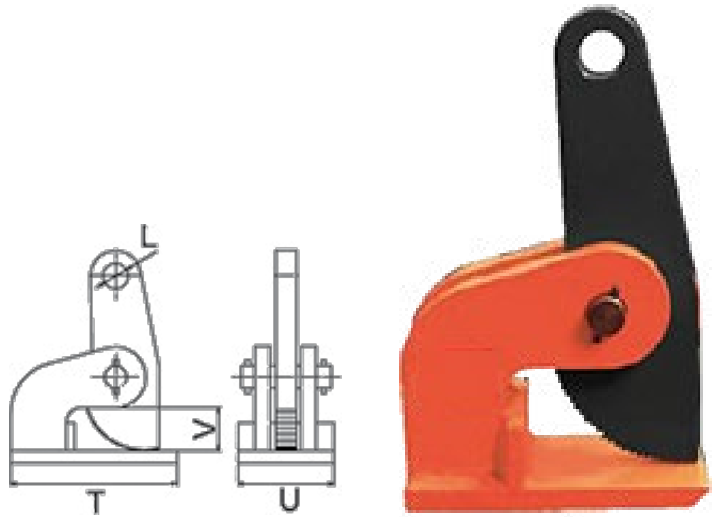

WLL (t)	Weight (kg)	Opening (mm)	T (mm)	U (mm)	V (mm)	L (mm)	Price / ea.	Part Number
2	7.5	0 - 60	180	80	68	25	281.60	6-2THPC
3	10	0 - 60	220	90	80	30	326.85	6-3THPC
5	20	0 - 100	220	110	123	45	591.82	6-5THPC
10	28	0 - 100	220	125	120	45	838.05	6-10THPC

CABLE SOCK - T-TYPE

- Double weave construction for medium to heavy pulling applications in underground installations.



Type	Line Capacity (mm)	WLL (kg)	Length of braid (mm)	Grip to end of loop (mm)	Price / ea.	Part Number
MG-10	7-12	300	330	85	95.27	6-MG10T
MG-15	13-18	400	330	85	112.46	6-MG15T

CABLE SOCK - K-TYPE

- Double weave construction for medium to heavy pulling applications in underground installations.
- Comes with swivel head which is ideal for connecting to shackles.



Type	Line Capacity (mm)	WLL (kg)	Length of braid to grip (mm)	Grip to end of swivel (mm)	Price / ea.	Part Number
LS-6	19-35	1100	630	180	226.93	6-LSK
MS-6	25-50	2000	760	200	325.88	6-MSK
MXS-7	38-60	2000	950	210	374.65	6-MXSK
XS-8	50-75	2500	1020	240	414.81	6-XSK

ROPE GRAB - PULLER

- **Recommended for fibre rope.**

Easy-to-use rope grab can be used with a variety fiber ropes. The large handle eye openings for easy opening, attaching and releasing to prevent lock-ups. Made of forged steel, its ideal for a variety of utility jobs.



Size (in)	Max rope size (in)	Min rope size (in)	MBL (lb)	Weight / each (lb)	Price / ea.	Part Number
1/2 - 3/4	3/4	1/2	8000	4	318.65	6-1/2"-3/4"RP

LIFTING CLUTCH

The concrete lifting clutch is used for lifting and transporting precast concrete elements with cast in spherical head anchors. The capacity loads are axial with a breakage design factor of 5. Designed to increase safety when lifting, shifting, or moving prefabricated concrete products, provided they are connected to the head of the correct anchor.

- Finish: Electro galvanized
- 100% Magnaflex Crack Detection
- Material: Alloy Steel
- Design factor: 5:1.
- Identification: Manufacturer, Batch Code, WLL
- Rated in metric tons.

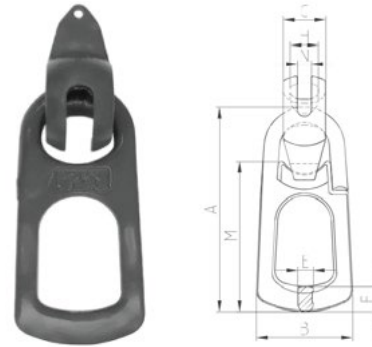

CONCRETE PRE-CAST LIFTING CLUTCHES

WLL Metric Ton	MBL Metric Ton	Weight/ ea. Kgs	Dimensions (mm)							Price/ ea.	Part Number
			A	B	C	M	E	N	H		
1.5T-2.5T	12.5	1.5	193	91.5	41	145	14	16	28	91.83	3-1.5T-2.5TLC
3T-5T	25	3.1	236	118	57	170	16	22	38.5	206.38	3-3T-5TLC
6T-10T	50	9	332	160	73	245.5	27	30	48.5	419.12	3-6T-10TLC

SPHERICAL HEAD PLATE ANCHOR

The Plate Anchors are standard anchors fitted with a welded base plate. They are designed to a load force in the range of 2.5t, 5.0t and 10.0t. These types of anchors are mostly used in thin panels.

- Finish: Hot Dip Galv
- Material: 2.5T - Alloy Steel, 5T and 10T - Carbon Steel
- Design Factor: 3:1
- Identification: Trademark, WLL, Batch Code, Pin Length
- Rated in metric tons.

LIFTING ANCHOR WITH PLATE

WLL Metric Ton	Pin Length mm	Plate Size mm	Price/ea.	Part Number
2.5T	55	70x70x6	4.82	3-2.5TX55MMSPA
2.5T	85	70x70x6	5.07	3-2.5TX85MMSPA
2.5T	120	70x70x6	5.56	3-2.5TX120MMSPA
5T	85	90x90x8	10.30	3-5TX85MMSPA
5T	110	90x90x8	11.61	3-5TX110MMSPA
10T	115	90x90x10	18.56	3-10TX115MMSPA



DRUM LIFTER

- For use on metal drums
- Rated in Metric Ton(s)



Capacity (t)	Chain size (mm)	Length of lift chain (mm)	Net Weight (kg)	Price / ea.	Part Number
1	6 x 18	500	3.6	157.41	6-DRUMLIFT



FALL ARREST

Carabiners, O-Ring & Fall Arrest Hooks.. 155 - 157



LINK - CARABINER, SELF-LOCKING, WITH CAPTIVE PIN, N-259G

- Material: Steel
- Standard: CSA Z259.12, EN 362, AMSI Z359
- Finish: Yellow Zinc
- Identification: Trademark, Batch Code

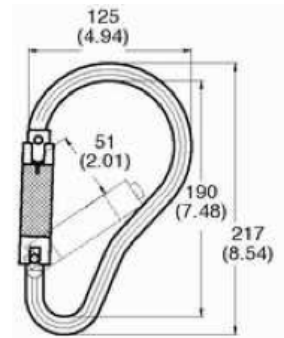

Captive Pin

Size	Min. Break Load	Gate Strength	Gate Opening	Net Weight	Price	Part Number
125 mm x 217 mm	5000 lb	3600 lb	51 mm	774 g	80.30	28-N-259GCP

LINK - CARABINER, SELF-LOCKING, WITH CAPTIVE PIN, N-252G

- Material: Steel
- Standard: CSA Z259.12, EN 362, AMSI Z359
- Finish: Yellow Zinc
- Identification: Trademark, Batch Code

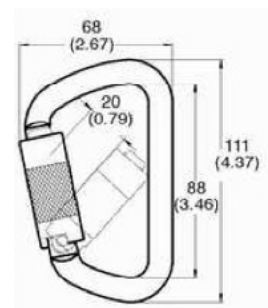

Captive Pin

Size	Min. Break Load	Gate Strength	Gate Opening	Net Weight	Price/ea.	Part Number
68 mm x 111 mm	5000 lb	3600 lb	20 mm	250 g	31.86	28-N-252GCP

LINK - CARABINER, SELF-LOCKING, WITH CAPTIVE PIN, N-256G

- Material: Steel
- Standard: CSA Z259.12, EN 362, AMSI Z359
- Finish: Yellow Zinc
- Identification: Trademark, Batch Code

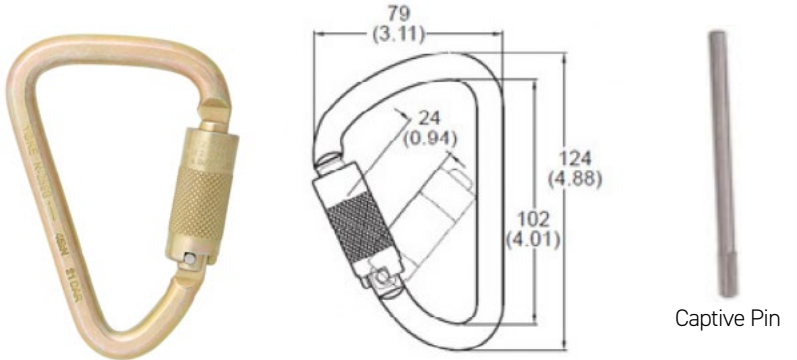

Size	Min. Break Load	Gate Strength	Gate Opening	Net Weight	Price / ea.	Part Number
79 mm x 124 mm	5000 lb	3600 lb	24 mm	279 g	39.11	28-N-256GCP

LINK - O-RING, N-489

- Material: Forged Steel, Heat Treated
- Standard: CSA Z259.12, EN 362, AMSI Z359
- Finish: Yellow Zinc
- Identification: Trademark, Batch Code

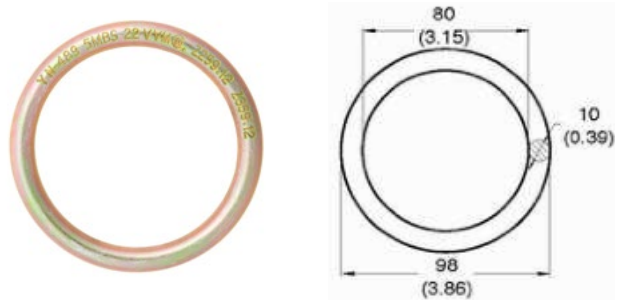

Size	Min. Break Load	Proof Load	Net Weight	Price / ea.	Part Number
10 mm x 80 mm	5000 lb	3600 lb	198 g	16.74	28-N-489

HOOK - REBAR, N-3630

- Material: Forged Steel, Heat Treated
- Standard: CSA Z259.12, EN 362, AMSI Z359
- Finish: Yellow Zinc
- Identification: Trademark, Batch Code

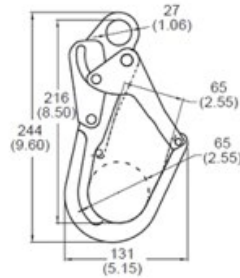

Size (in)	Min. Break Load	Gate Strength	Net Weight	Price / ea.	Part Number
2 1/4	5000 lb	3600 lb	788 g	73.08	28-N-3630

HOOK - SNAP, N-3610

- Material: Forged Steel, Heat Treated
- Standard: CSA Z259.12, EN 362, AMSI Z359
- Finish: Yellow Zinc
- Identification: Trademark, Batch Code

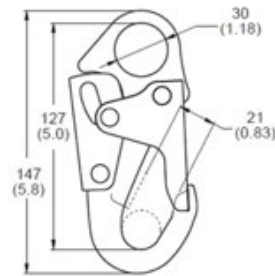

Lock Type	Min. Break Load	Gate Strength	Net Weight	Price / ea.	Part Number
Double Lock	5000 lb	3600 lb	390 g	28.62	28-N-3610

HOOK - REBAR, N-3620

- Material: Forged Steel, Heat Treated
- Standard: CSA Z259.12, EN 362, AMSI Z359
- Finish: Zinc Plated
- Identification: Trademark, Batch Code

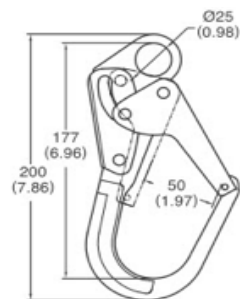

For Rebar Size (in)	Min. Break Load	Gate Strength	Net Weight	Price / ea.	Part Number
1 3/4	5000 lb	3600 lb	543 g	64.44	28-N-3620

TOOLS

Hand Swagers & Cutters159
Bolt Cutters160

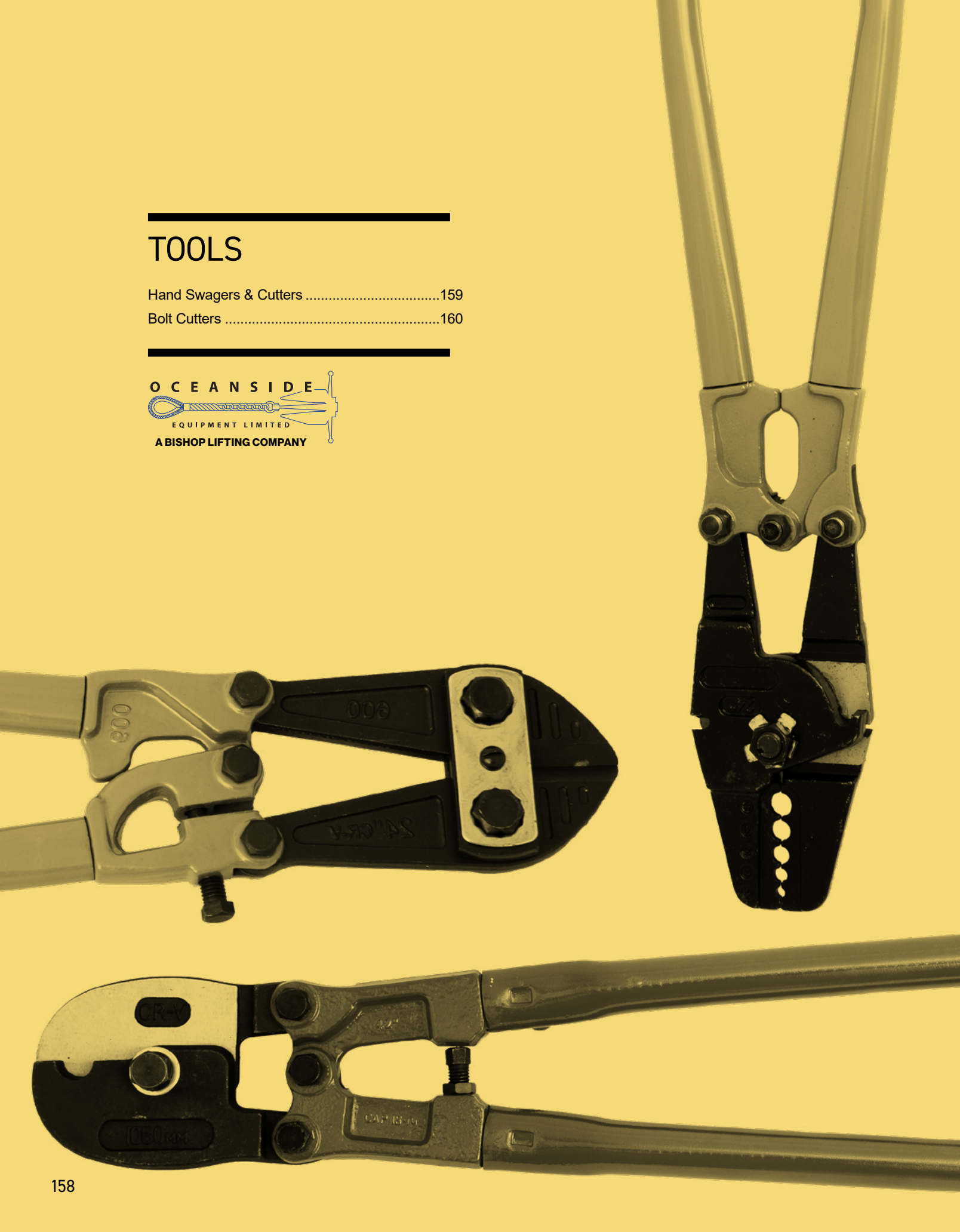

TOOL - SWAGER CUTTER

- Blades drop forged with high quality alloy steel body with heat treatment, cutting edges induction quenched, good cutting by 2 grade lever principal. Used to cut up to 6mm wire rope and press 1/16" to 3/16" aluminium oval sleeves.

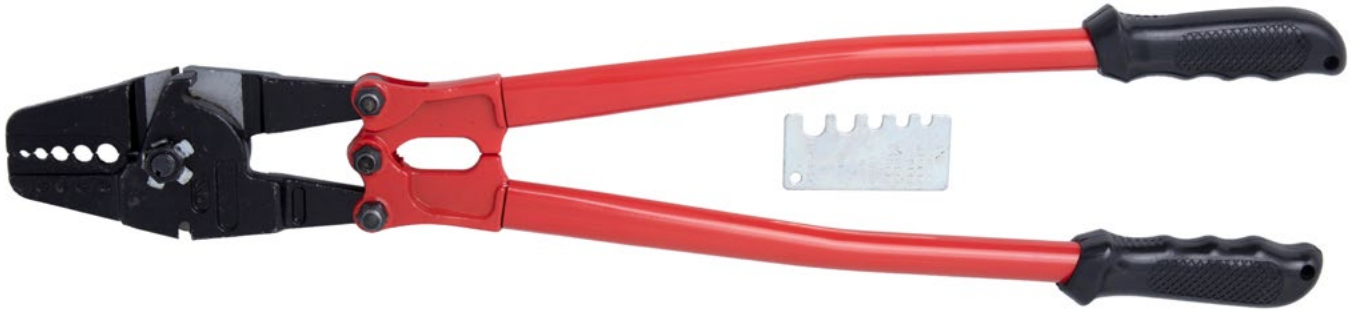

Size (in)	Replacement Head		Unit	
	Price / ea.	Part Number	Price / ea.	Part Number
24	69.46	6-24SH	223.65	6-24S

TOOL - WIRE CUTTER

- Used with 2 grade lever principal for easy cutting, used for cutting steel wires.



Size (in)	Steel Bar cut max. (mm)	Wire cut max. (mm)	Replacement Head ONLY		Unit	
			Price / ea.	Part Number	Price / ea.	Part Number
42	13	22	159.95	6-42WCSJ	419.70	6-42WC

TOOL - BOLT CUTTER

- Exceeds Fed Spec GGG-C-470D type II 3&4 – Alloy steel blades.
Rubber grip steel tubular handles. Toggle joint that transforms 50 pounds of hand pressure to 4,000 pounds pressure on cutting edges of the jaws. Adjustment bolt to align cutting heads. Blades are drop forged with cutting edges induction quenched.
- Maximum hardness of material to be cut HRC40.



Size (in)	Replacement Head ONLY		Bolt Cutter Unit	
	Price / ea.	Part Number	Price / ea.	Part Number
12	26.11	6-12BCSH	54.99	6-12BC
14	31.86	6-14BCSH	66.01	6-14BC
18	39.33	6-18BCSH	76.61	6-18BC
24	49.79	6-24BCSH	103.90	6-24BC
30	61.98	6-30BCSH	153.21	6-30BC
36	-	-	192.53	6-36BC
42	-	-	257.20	6-42BC



MARINE

Swivel Forerunners163
Stud-Link & Open Link Chain 165-167
Kenter Shackles, Chain Stoppers
& Pear Links..... 168 - 171
Triangle Plates, Recessed & Split Links.. 172 - 173
Round Rings and Lobster Swivels.....174
Cleats & Hinges177
Oar Locks and Knives..... 176 - 177
Bait Bags and Jars..... 177 -178
Stenhouse Slips, & Washers178
Anchors 179 - 188
Marine Hardware, Grapnels
& Chain Chasers..... 189 - 193
Fenders & Deck Equipment..... 194-215



AQUACULTURE GEAR AVAILABLE FROM STOCK

MARINE

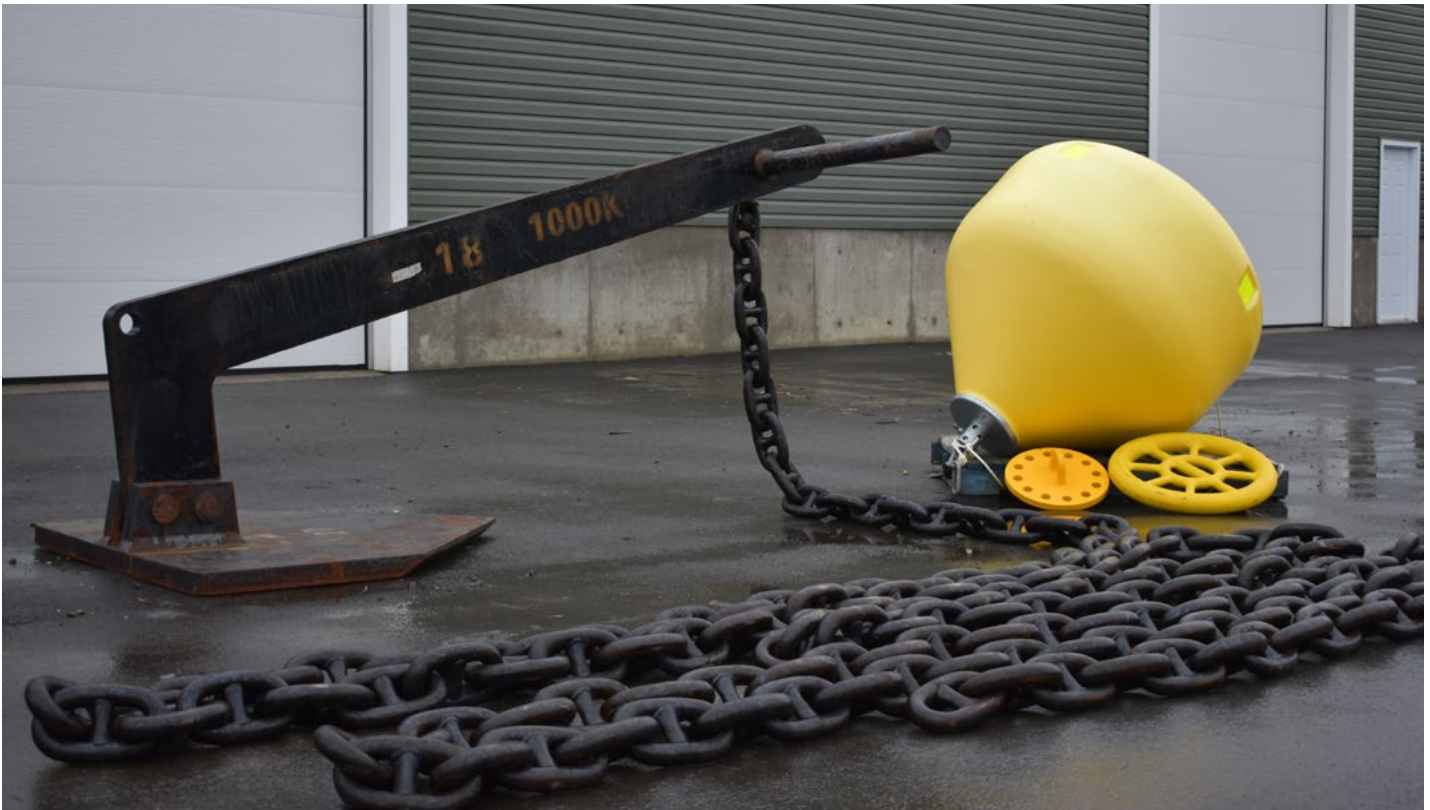

SWIVEL - SHORT BOW

Type	Price / ea.	Part Number
1-1/8" short bow swivels	368.25	6-1-1/8"SBSWL



SWIVEL - FORERUNNER, ASSEMBLY, WITH LINKS

- Material: Grade 3
- Standard: ISO 1704
- Finish: Black Bitumen
- Identification: Size/WLL, Batch Code
- Cert



Chain Dia. mm	Dimensions (mm)							Weight (lb)	Proof Load (lb)	Break Load (lb)	Price / ea.	Part Number
	A	B	C	D	E	F	G					
17-19	173	76	76	66	27	19	19	5.0	47 210	67 443	1659.18	20-19MMSFR
20.5	185.5	83	83	48	29	21	21	6	54 850	78 460	1745.68	20-20.5MMSFR
21-22	198	90	90	30	30	22	22	7.1	63 171	90 148	1819.67	20-22MMSFR
24-29	258	102	102	44	44	25	25	14.3	101 164	144 327	1860.91	20-28MMSFR
30-35	290	160	124	116	116	25	36	46.3	147 250	210 421	3246.84	20-34MMSFR
36-42	373	202	146	145	145	32	46	87.1	182 545	260 778	3617.71	20-38MMSFR
43-48	430	230	165	183	183	36	60	145.5	263 251	376 105	9596.45	20-46MMSFR
49-58	516	278	200	212	212	39	65	229.2	382 625	546 286	12297.63	20-56MMSFR
59-67	575	307	230	235	235	46	68	313.1	491 657	702 078	13987.74	20-64MMSFR

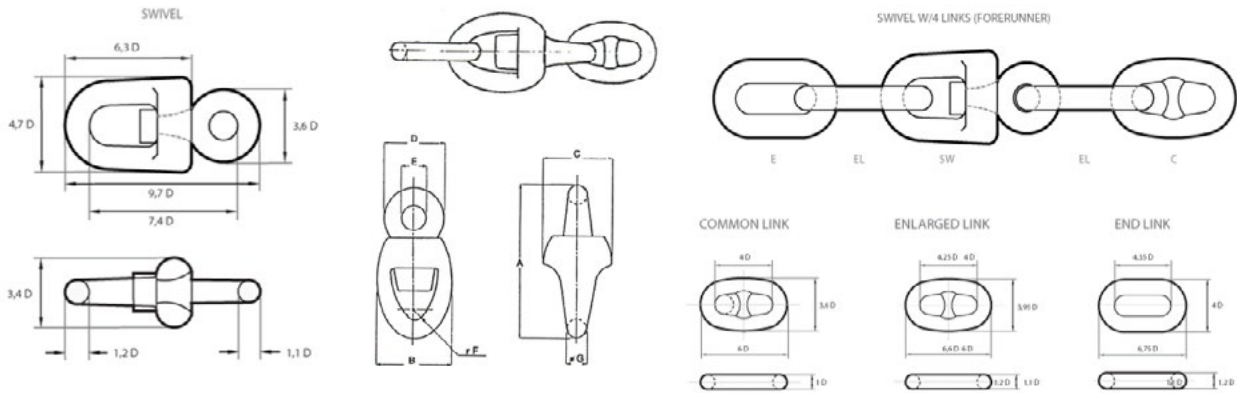

Chain size (mm)	Dimensions (mm)							Weight (kg)	Proof Load (lb)	Break Load (lb)
	A	B	C	D	E	F	G			
13-16	137	62	62	52	20	12	16	1.35	33,280	47,606
17-19	173	76	76	66	27	19	19	2.25	47,210	67,443
21-22	198	90	90	30	30	22	22	3.20	63,171	90,148
24-29	258	102	102	44	44	25	25	6.5	101,164	144,327
30-35	290	160	124	116	116	25	36	21	147,250	210,421
36-42	373	202	146	145	145	32	46	39.5	182,545	260,778
43-48	430	230	165	183	183	36	60	66	263,251	376,105
49-58	516	278	200	212	212	39	65	104	382,625	546,286
59-67	575	307	230	235	235	46	68	142	491,657	702,078
68-73	650	345	260	256	256	50	79	208	628,140	897,028
75-79	757	370	325	281	281	62	94	276	731,948	1,045,798
81-86	760	420	272	310	310	57	95	336	847,218	1,210,216
87-92	800	430	290	320	320	60	98	376	958,299	1,369,125
94-98	882	460	333	354	354	66	118	557	1,079,960	1,542,815
100-102	918	480	348	368	368	69	122	612	1,150,708	1,644,184
105-111	1000	530	378	400	400	74	133	797	1,337,828	1,911,309
114	1026	542	390	417	417	76	137	871	1,404,609	2,007,624

Reference Material

CHAIN - OPEN LINK

- Sold in 90 ft shots
- Material: Grade 2
- Standard: ISO 1704
- Finish: Black Bitumen
- Identification: Size/WLL, Batch Code



Diameter (in)	Weight / 90 ft shot (lb)	Inside Length (in)	Inside Width (in)	Break Load (lb)	Price / ea.	Part Number
3/4	445	3	1.11	42 000	2514.57	6-3/4G20L
1 1/8	990	4.33	1.70	91 100	4398.72	6-1-1/8G20L
1 1/4	1256	5	1.97	128 714	5071.80	6-1-1/4G20L

CHAIN - STUD LINK ANCHOR

- Sold in 90 ft shots
- Material: Grade 2, 3
- Standard: ISO 1704
- Finish: Black Bitumen
- Identification: Size/WLL, Batch Code
- Certification: Lloyd's Certificate (on request)



Dia. (in)	Dia. (mm)	Grade	Weight / 15 fathom (lb)	Break Load (lb)	Price / ea.	Part Number
13/32	20.5	3	590	78 460	6,141.09	6-20.5MMG3SL
7/8	22	2	660	64 400	4262.45	6-7/8G2SL
1	25	2	860	83 600	5554.10	6-1G2SL
1 1/8	28	2	1080	105 000	6974.91	6-1-1/8G2SL
1 1/4	32	2	1350	129 000	8718.64	6-1-1/4G2SL
1 1/2	38	3	1940	262 000	12529.01	6-1-1/2G3SL
1 5/8	42	3	2240	306 000	14466.48	26-42MMU3SL
2	51	3	3360	454 000	21699.72	6-2G3SL
2 1/2	64	3	5270	692 000	34034.98	6-2-1/2G3SL

To prevent the possibility of serious bodily harm: DO NOT EXCEED the working load limit of chain or components. NOT USE FOR OVERHEAD LIFTING OR HOISTING. DO NOT USE if the chain or components are visibly distorted or worn.

CHAIN - STUD LINK ANCHOR

- Reference Chart estimate formulated values
- Sizes available up to 210 mm
- See page 183 for in-stock Stud Link Anchor Chain



Chain size		Link Length		5 Links			Grip Radius	Weight / 15 fathom shot (approx.) (lb)	No. of links / 15 fathom shot (lb)	Grade 2		Grade 3		Grade 4	
(in)	(mm)	A (in)	B (in)	C (in)	D (in)	Proof Test (lb)				Break Test (lb)	Proof Test (lb)	Break Test (lb)	Proof Test (lb)	Break Test (lb)	
5/8	16	3-3/4	2-1/4	13-3/4	3/8	365	432	23,745	33,220	33,220	47,465	53105	67365		
3/4	19	4-1/2	2-5/8	16-1/2	1/2	480	357	34,000	47,600	47,600	68,000	74466	94462		
13/16	20	4-7/8	2-7/8	17-7/8	17/32	570	329	39,800	55,700	55,700	79,500	82356	104470		
7/8	22	5-1/4	3-1/8	19-1/4	37/64	660	305	46,000	64,400	64,400	91,800	99274	125931		
15/16	24	5-5/8	3-5/16	20-5/8	5/8	760	285	52,600	73,700	73,700	105,000	117697	149301		
1	25	6	3-9/16	22	21/32	860	267	59,700	83,600	83,600	119,500	127467	161694		
1-1/16	27	6-3/8	3-3/4	23-3/8	11/16	970	251	67,200	94,100	94,100	135,000	148111	187881		
1-1/8	28	6-3/4	4	24-3/4	25/32	1080	237	75,000	105,000	105,000	150,000	158980	201670		
1-3/16	30	7-1/8	4-1/4	26-1/8	25/32	1220	225	83,400	116,500	116,500	167,000	181804	230622		
1-1/4	32	7-1/2	4-1/2	27-1/2	25/32	1350	213	92,200	129,000	129,000	184,000	206057	261387		
1-5/16	33	7-7/8	4-3/4	28-7/8	7/8	1490	203	101,500	142,000	142,000	203,000	218714	277442		
1-3/8	34	8-1/4	4-15/16	30-1/4	7/8	1630	195	111,000	155,000	155,000	222,000	231721	293942		
1-7/16	36	8-5/8	5-3/16	31-5/8	15/16	1780	187	120,500	169,000	169,000	241,000	258777	328263		
1-1/2	38	9	5-3/8	33	63/64	1940	179	131,000	183,500	183,500	262,000	287207	364327		
1-9/16	40	9-3/8	5-5/8	34-3/8	1-1/32	2090	171	142,000	198,500	198,500	284,000	316991	402109		
1-5/8	42	9-3/4	5-7/8	35-3/4	1-1/16	2240	165	153,000	214,000	214,000	306,000	348112	441587		
1-11/16	43	10-1/8	6-1/16	37-1/8	1-3/32	2410	159	166,500	229,000	229,000	327,000	364168	461954		
1-3/4	44	10-1/2	6-5/16	38-1/2	1-5/32	2590	153	176,000	247,000	247,000	352,000	380551	482736		
1-13/16	46	10-7/8	6-1/2	39-7/8	1-3/16	2790	147	188,500	264,000	264,000	377,000	414289	525533		
1-7/8	48	11-1/4	6-3/4	41-1/4	1-1/4	2980	143	201,000	281,000	281,000	402,000	449307	569955		
1-15/16	50	11-5/8	7	42-5/8	1-9/32	3180	139	214,000	299,000	299,000	427,000	485587	615976		
2	51	12	7-3/16	44	1-5/16	3360	133	227,000	318,000	318,000	454,000	504195	639580		
2-1/16	52	12-3/8	7-7/16	45-3/8	1-3/8	3570	129	241,000	337,000	337,000	482,000	523110	663575		
2-1/8	54	12-3/4	7-5/8	46-3/4	1-27/64	3790	125	255,000	357,000	357,000	510,000	561858	712727		
2-3/16	56	13-1/8	7-7/8	48-1/8	1-15/32	4020	123	269,000	377,000	377,000	538,000	601811	763409		
2-1/4	58	13-1/2	8-1/8	49-1/2	1-1/2	4250	119	284,000	396,000	396,000	570,000	642952	815596		
2-5/16	59	13-7/8	8-5/16	50-7/8	1-17/32	4490	117	299,000	418,000	418,000	598,000	663961	842247		
2-3/8	60	14-1/4	8-9/16	52-1/4	1-9/16	4730	113	314,000	440,000	440,000	628,000	685261	869266		
2-7/16	62	14-5/8	8-3/4	53-5/8	1-5/8	4960	111	330,000	462,000	462,000	660,000	728720	924394		
2-1/2	64	15	9	55	1-5/8	5270	107	346,000	484,000	484,000	692,000	773310	980958		
2-9/16	66	15-3/8	9-1/4	56-3/8	1-11/16	5540	105	363,000	507,000	507,000	726,000	819012	1038932		
2-5/8	67	15-3/4	9-7/16	57-3/4	1-11/16	5820	103	379,000	530,000	530,000	758,000	842275	1068442		
2-11/16	68	16-1/8	9-11/16	59-1/8	1-3/4	6110	99	396,000	554,000	554,000	792,000	865809	1098295		
2-3/4	70	16-1/2	9-7/8	60-1/2	1-13/16	6410	97	413,000	578,000	578,000	826,000	913681	1159021		
2-13/16	71	16-7/8	10-1/8	61-7/8	1-27/32	6710	95	431,000	603,000	603,000	861,000	938014	1189889		
2-7/8	73	17-1/4	10-3/8	63-1/4	1-7/8	7020	93	449,000	628,000	628,000	897,000	987464	1252617		
2-15/16	75	17-5/8	10-9/16	64-5/8	1-7/8	7330	91	467,000	654,000	654,000	934,000	1037943	1316650		

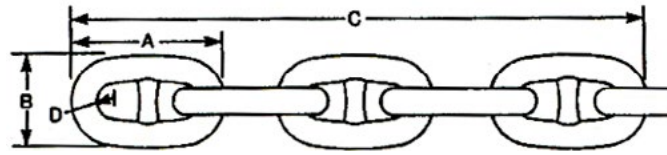

Chain size		Link Length		5 Links C (in)	Grip Radius D (in)	Weight / 15 fathom shot (aprox.) (lb)	No. of links / 15 fath- om shot (lb)	Grade 2		Grade 3		Grade 4	
(in)	(mm)	A (in)	B (in)					Proof Test (lb)	Break Test (lb)	Proof Test (lb)	Break Test (lb)	Proof Test (lb)	Break Test (lb)
3	76	18	10-13/16	66	2	7650	89	485000	679000	679000	970000	1063562	1349148
3-1/16	78	18-3/8	11	67-3/8	2	7980	87	504000	705000	705000	1008000	1115549	1415094
3-1/8	79	18-3/4	11-1/4	68-3/4	2-1/16	8320	85	523000	732000	732000	1046000	1141911	1448536
3-3/16	81	19-1/8	11-1/2	70-1/8	2-1/16	8660	85	542000	759000	759000	1084000	1195364	1516341
3-1/4	83	19-1/2	11-11/16	71-1/2	2-1/8	9010	83	562000	787000	787000	1124000	1249771	1585357
3-5/16	84	19-7/8	11-15/16	72-7/8	2-1/8	9360	81	582000	814000	814000	1163000	1277326	1620312
3-3/8	86	20-1/4	12-1/8	74-1/4	2-3/16	9730	79	602000	843000	843000	1204000	1333129	1691099
3-7/16	87	20-5/8	12-3/8	75-5/8	2-3/16	10100	77	622000	871000	871000	1244000	1361372	1726925
3-1/2	90	21	12-5/8	77	2-5/16	10500	77	643000	900000	900000	1285000	1447439	1836103
3-5/8	92	21-3/4	12-15/16	79-3/4	2-5/16	11300	73	685000	958000	958000	1369000	1505908	1910272
3-3/4	95	22-1/2	13-3/8	82-1/2	2-15/32	12000	71	728000	1019000	1019000	1455000	1595203	2023544
3-7/8	98	23-1/4	14	85-1/4	2-15/32	12900	69	772000	1080000	1080000	1543000	1686351	2139167
4	102	24	14-3/8	88	2-5/8	13700	67	816000	1143000	1143000	1673200	1810655	2296849
4-1/8	105	24-3/4	14-11/16	90-3/4	2-11/16	14560	65	861800	1206600	1206600	1723700	1905881	2417646
4-1/4	109	25-1/2	15-3/16	93-1/2	2-3/4	15350	63	908300	1271800	1271800	1816800	2035396	2581937
4-3/8	111	26-1/4	15-9/16	96-1/4	2-7/8	16200	61	955700	1338000	1338000	1911300	2101202	2665413
4-1/2	114	27	16	99	2-15/16	17100	59	1003700	1405300	1405300	2007500	2201169	2792224
4-5/8	117	27-3/4	16-7/16	101.75	3	18000	57	1052600	1473600	1473600	2105200	2302592	2920880
4-3/4	120	28-1/2	16-7/8	104.5	3-1/16	18900	57	1102100	1542900	1542900	2204200	2405405	3051301
4-13/16	122	28-11/16	17	105.87	3-1/8	19400	57	1127300	1578200	1578200	2254600	2474689	3139189
4-7/8	124	29-1/4	17-3/8	107.25	3-3/16	19900	55	1152500	1613400	1613400	2304900	2544546	3227803
5	127	30	17-13/16	110	3-1/4	20900	53	1203300	1684600	1684600	2406600	2650361	3362032
5-1/8	130	30-3/4	18-1/4	112.75	3-5/16	22000	52	1254700	1756600	1756600	2509400	2757359	3497761
5-3/16	132	31-1/8	18-7/16	114.12	3-3/8	22500	51	1280600	1792900	1792900	2561300	2829316	3589040
5-7/16	139	32-5/8	19-3/8	119.62	3-1/2	24500	49	1385700	1940000	1940000	2771400	3084812	3913141
5-5/8	144	33-3/4	20	123.75	3-11/16	26100	47	1465800	2052100	2052100	2931500	3270456	4148634
5-13/16	148	34-15/16	20-3/4	127.87	3-3/4	27600	46	1546800	2165500	2165500	3093600	3420635	4339139
6	152	36	21-3/8	130	3-7/8	29100	45	1628700	2280200	2280200	3257400	3572132	4531316

A potential hazard exists when lifting or dragging heavy loads with tackle block assemblies. Failure to design and use tackle block systems properly may cause a load to slip or fall, the result could be serious injury or death. A tackle block system should be rigged by a qualified person as defined by ANSI/ASME B30.

SHACKLE - KENTER SHACKLE, JOINING LINK

- Material: Grade 2, 3
- Standard: ISO 1704
- Certification: Lloyd's Certificate (on request)
- Identification: Size/WLL, Batch Code
- Finish: Black Bitumen



Size (in)	Grade	Price / ea.	Part Number
13/32	3	526.13	6-20.5MMKS3
7/8	2	490.29	6-7/8"KS2
1	2	539.65	6-1"KS2
1-1/8	2	565.48	6-1-1/8"KS2
1-1/4	2	727.53	6-1-1/4"KS2
1-1/2	2	912.45	6-1-1/2"KS2
1-1/2	3	1175.19	6-1-1/2"KS3
1-5/8	3	1386.88	26-42MMU3KS
2	3	2151.13	6-2"KS3
2-1/4	3	3167.51	6-2-1/4"KS3
2-1/2	3	3893.66	6-2-1/2"KS3

TURNBUCKLE - CHAIN STOPPER ASSEMBLY, DEVIL'S CLAW

- Material: Grade 3
- Standard: ISO 1704
- Finish: Black Bitumen
- Identification: Size/WLL
- Rated in Metric Ton(s)

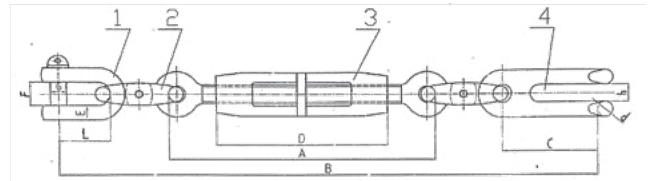

Chain Size		MPF (t)	MBF (t)	Dimensions (mm)											Price / ea.	Part Number
(in)	(mm)			B Min.	B Max.	A	D	C	E	F	G	h	d	L		
3/4 - 7/8	19 - 22	29.3	41.7	876	1067	438	279	134.5	25	43	34	27	26	95.5	10980.21	20-19-22MMDCCS
15/16 - 1 1/4	24 - 32	58.6	83.6	1186	1415	589	380	229	32	52	44	37	33	117.5	13195.69	20-24-32MMDCCS
1 5/16 - 1 5/8	33 - 41	83.3	118.9	1346	1613	604	406	264	38	60	55	46	45	142.5	14551.80	20-33-41MMDCCS
1 11/16 - 2 3/8	43 - 60	83.3	118.9	1454	1721	612	406	355	41	73	55	65	65	150	16982.24	20-43-60MMDCCS

SHACKLE - KENTER SHACKLE, JOINING LINK

- Pricing on availability
- Sizes available up to 162 mm
- See page 184 for in-stock Kenter Shackles
- Measurements are in millimeter(s)

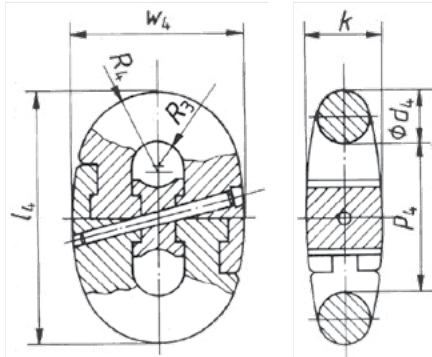
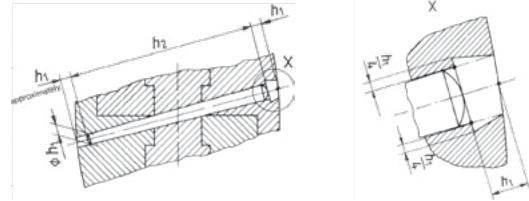

Nominal Size (d common link = d4)	l4	p4	w4	h1	h2	k	R3	R4
12.5	75	50	53	4	45	19	8.5	23
14	84	56	59	6	45	21	9.5	26
16	96	64	67		55	24	10.5	29
17.5	105	70	74	10	60	27	12	32
19	114	76	80		65	29	13	35
20.5	123	82	86		70	31	14	38
22	132	88	92	12	75	33	15	40
24	144	96	101		80	36	16	44
26	156	104	109		85	40	17.5	48
28	168	112	118		95	43	19	51
30	180	120	126	16	100	46	20	55
32	192	128	134		110	49	21.5	59
34	204	136	143	12	115	52	23	62
36	216	144	151		120	55	24	66
38	228	152	160		130	58	25	70
40	240	160	168	16	140	61	27	73
42	252	168	176		140	64	28	77
44	264	176	185	16	150	67	29	81
46	276	184	193		160	70	31	84

Nominal Size (d common link = d4)	l4	p4	w4	h1	h2	k	R3	R4
48	288	192	202	16	160	73	32	88
50	300	200	210		170	76	34	92
52	312	208	218		180	79	35	95
54	324	216	227		180	82	36	99
56	336	224	235	20	190	85	38	102
58	348	232	244		200	88	39	106
60	360	240	252		200	91	40	110
62	372	248	260		220	94	42	113
64	384	256	269	25	220	97	43	117
66	396	264	277		220	100	44	121
68	408	272	286		220	103	46	124
70	420	280	294		240	106	47	128
73	438	292	307	30	260	111	49	134
76	456	304	319		260	115	51	139
78	468	312	328		260	119	52	143
81	486	324	340		280	123	54	148
84	504	336	353	35	280	128	57	154
87	522	348	365		300	132	58	159
90	540	360	378		300	137	60	165
92	552	368	386		320	140	62	168
95	570	380	399	40	320	144	64	174
97	582	388	407		340	147	65	178
100	600	400	420		340	152	67	183
102	612	408	428		360	155	68	187
105	630	420	441	40	360	160	70	192
107	642	428	449		360	163	72	196
111	666	444	466		380	169	74	203
114	684	456	479		380	173	76	207

Reference Materials

LINK - CONNECTING, PEAR, ANCHOR JOINING

- See page 201 for schematics
- Material: Grade 3
- Standard: ISO 1704
- Finish: Black Bitumen
- Identification: Size/WLL, Batch Code
- Certification: ABS Certificate (on request)

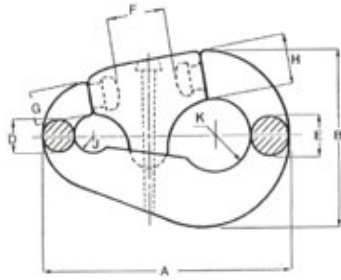

No.	Size (mm)	Weight (lb)	Proof Load (lb)	Break Load (lb)	Price / ea.	Part Number
2	19-24	7.9	74 861	107 009	4582.16	20-#2PEARLINK
3	25-30	14.3	115 552	165 235	5293.54	20-#3PEARLINK
4	32-40	32.0	201 654	288 879	5653.87	20-#4PEARLINK
5	42-51	59.5	319 678	457 486	7515.27	20-#5PEARLINK
6	52-60	108.0	436 579	621 822	12163.79	20-#6PEARLINK

LINK - CONNECTING LINK FOR PENNANT LINES, GN®

- Material: Alloy steel
- Finish: Painted
- Design Factor: 5:1
- Temperature Range: -20°C up to +200°C
- Certification: Certificate of Conformity
3.1 material certificate EN 10204
- Rated in Metric Ton(s)

WLL (t)	PL (t)	Dimensions (mm)						Wt./ea. (kg)	Price
		A	B	C	D	E	F		
110	220	560	360	108	76	156	150	76	Pricing on Request

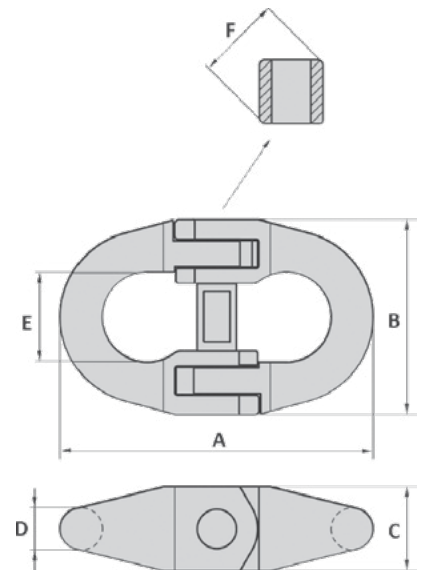

LINK - CONNECTING, PEAR, ANCHOR JOINING

- Pricing on availability
- See Page 185 for in-stock Pear Links

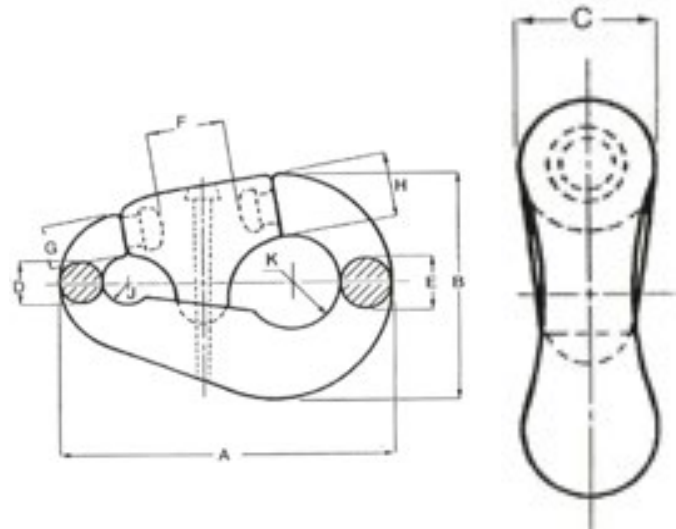

No	Size (mm)	Dimensions (mm)										Wt. (kg)	Proof (lb)	Break (lb)
		A	B	C	D	E	F	G	H	J	K			
2	19-24	194	132	38	24	32	57	24	35	17	30	3.6	74 936	106 894
3	25-30	238	167	46	30	38	66	33	45	19	35	6.5	116 812	166 843
4	32-40	299	206	59	40	48	83	40 x 4 5	56	26	43	14.5	201 446	288 724
5	42-51	378	260	76	51	64	100	51 x 60	74	32	52	27	320 462	457 771
6	52-60	454	313	92	60	76	121	62 x 73	88	37	64	49	439 918	628 581
7	62-79	562	376	121	79	95	149	86 x 79	111	48	76	92	731 948	1 045 798
8	81-92	654	419	133	92	124	149	111 x 102	130x133	54	79	149	958 299	1 369 125
9	94-95	692	435	146	98	130	159	124 x 137	141	57	83	236	1 018 909	1 454 860
10	97-102	889	572	191	121	165	191	130 x 148	181	73	108	386	1 150 708	1 644 184
11	103-108	940	610	203	127	175	203	156	200	76	111	418	1 271 708	1 818 300
12	110-114	991	648	216	133	184	216	165 x 167	210 x 200	105	114	459	1 404 609	2 007 624

A potential hazard exists when lifting or dragging heavy loads with tackle block assemblies. Failure to design and use tackle block systems properly may cause a load to slip or fall, the result could be serious injury or death. A tackle block system should be rigged by a qualified person as defined by ANSI/ASME B30.

TRIANGLE PLATE - GN®



Made in Holland

- Material: High tensile steel
- Design Factor: 5:1
- Finish: Painted
- Temperature Range: -40°F up to +392°F, Polar Rated

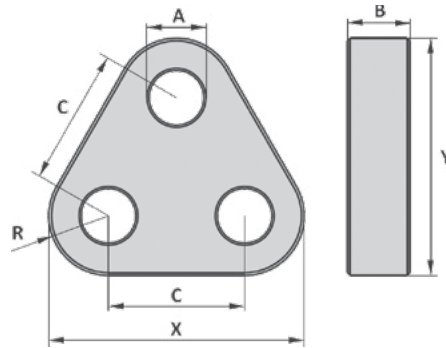

"Tolerance +/- 5%"

WLL (t)	MBL (t)	Dimensions (mm)						Wt./ea. (kg)	Price / ea.	Part Number
		A	B	C	R	X	Y			
17	85	47	35	120	65	250	234	10	\$2,634.85	116-TR117
25	125	55	40	150	80	310	290	18	Pricing on Request	-
35	175	60	50	160	90	340	319	28		-
55	275	75	70	210	105	420	392	58	5,223.75	116-TR155T
85	425	90	80	230	135	500	469	96	6,594.00	116-TR185T
120	600	105	100	280	170	620	582	188	Pricing on Request	-
150	750	115	110	320	185	690	647	256		-
175	875	115	110	320	195	710	667	274		-
200	1000	140	120	390	215	820	768	390		-
250	1250	150	140	390	240	870	818	518		-
300	1500	160	150	420	250	920	864	617		-
400	2000	185	200	490	300	1090	1024	1170		-
500	2500	200	200	550	360	1270	1196	1619		-
600	3000	220	200	600	400	1400	1320	1972		-
700	3500	230	250	600	400	1400	1320	2452		-

HOOK - G, ALLOY, GRADE 80 / LINK - RECESSED, ALLOY, GRADE 80

- Material: Grade 80, Alloy Steel
- Standard: EN 13001-3-5, EN 1677-4
- Finish: Painted Yellow
- Design Factor: 5:1
- Identification: Size/WLL
- Rated in Metric Ton(s)

Size (in)	WLL (t)	Price / ea.	Part Number
Hook "G" Alloy Forged			
3/4	2	44.97	6-3/4"GHF
1	6	87.10	6-1"GHF
Double recessed links Alloy Forged			
3/4	2	27.61	6-3/4"DRL
1	6	61.74	6-1"DRL



LINK - SPLIT, ALLOY, LOBSTER LINK

- Material: Alloy Mild Steel
- Finish: Galvanized

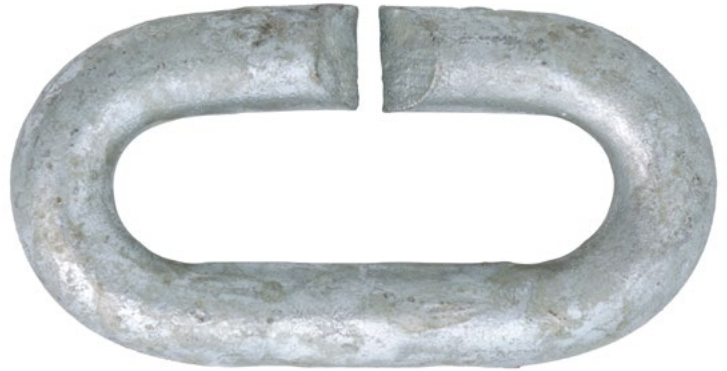

Size (in)	Qty. / Bag	Price / ea.	Part Number
3/8	300	2.46	6-10MMSL
1/2	200	3.99	6-13MMSL
5/8	60	7.47	6-16MMSL



RING - ROUND

Not Load Rated

Stainless Steel:

Size (in)	Dia. (in)	I.D. (in)	O.D. (in)	Price / ea.	Part Number
1/4 x 2	1/4	2.00	2.50	5.00	6-1/4X2SSRR
5/16 x 2	5/16	2.00	2.62	8.15	6-5/16X2SSRR
3/8 x 2-1/2	3/8	2.50	3.25	17.83	6-3/8X2 1/2SSRR
1/2 x 3	1/2	3.00	4.00	23.04	6-1/2X3SSRR



Zinc:

Size (in)	Dia. (in)	I.D. (in)	O.D. (in)	Price / ea.	Part Number
1/4 x 3	1/4	3.00	3.50	0.33	6-1/4X3RR

SWIVEL - LOBSTER

- Material: 316 Stainless Steel
- Finish: Stainless Steel

Size	Price / ea.	Part Number
Small	13.12	6-SMSWIVEL
Large	14.16	6-LGSWIVEL



CLEAT - DOCK, HEAVY DUTY

- Material: Steel
- Standard: ASTM F1074
- Finish: Galvanized, Painted
- Identification: Size

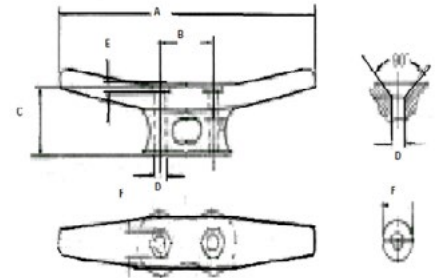

Size (in)	Dimensions (in)						Weight (lb)	Bolt	Price / ea.	Part Number
	A	B	C	D	E	F				
5	5.00	1.08	1.05	0.26	0.09	0.43	0.33	#12	3.78	6-5CLHH
6	5.88	1.25	1.09	0.31	0.19	0.45	0.38	1/4	5.22	6-6CLHH
8	8.00	1.63	1.56	0.38	0.25	0.52	1.00	5/16	15.25	6-8CLHH
10	10.25	2.38	1.93	0.44	0.28	0.58	2.00	3/8	20.47	6-10CLHH
12	12.25	3.83	2.38	0.44	0.28	0.58	3.60	3/8	31.60	6-12CLHH
14	14.31	4.25	2.63	0.57	0.36	0.77	5.88	1/2	52.21	6-14CLHH
18	18.00	5.38	3.50	0.69	0.47	0.97	11.00	5/8	136.32	6-18CLHH
20	18.50	7.00	3.50	1.00	0.75	2.25	29.00	3/4	202.35	6-20CLHH
24 (primer only) B1 Style`	24.00	6.00	6.87	1.12	2.5	4	91.00	7/8	492.56	6-24"CLHHB1
24 (primer only) B2 Style`	24.00	5.50	8.00	1.12	2.5	4	95.00	7/8	618.76	6-24"CLHHB2



18" Galvanized Cleat



20" Galvanized Cleat



24" B1 Style



24" B2 Style

HINGE - BUTT, HEAVY DUTY

- Material/Finish: 316 Stainless Steel



Length	Size (in)		Price / ea.	Part Number
	Width			
1 1/2	1 1/2		18.44	6-1-1/2" BHSS
2	2		21.06	6-2" BHSS
3	3		43.56	6-3" BHSS
4	4		71.29	6-4" BHSS

HINGE - STRAP

- Material/Finish: 304 Stainless Steel



Length	Size (in)		Price / ea.	Part Number
	Width			
3 1/2	1 1/2		48.65	6-3-1/2" SH304
5	1 1/2		55.73	6-5" SH304
8	2		130.82	6-8" SH304

OAR LOCK



Finish	Description	Price / ea.	Part Number
Galvanized	# 2 oar lock	15.82	6-HDGOL
Galv. Socket	Gunwale	7.11	6-HDGGG
Galv. Socket	Side Mount	7.11	6-HDGSMS

KNIFE - BAIT



Blade Length (in)	Handle Length (in)	Overall Length (in)	Price / ea.	Part Number
11.00	6.00	17.00	39.75	6-BAITKNIFE

KNIFE - SCALLOP



Blade Length (in)	Handle Length (in)	Overall Length (in)	Price / ea.	Part Number
4.50	3.50	8.00	16.64	6-SCKNIFE

BAG - BAIT

- Offset Velcro Closure easy opening, stainless steel grommet, and tag on side to hang bag sideways.
- Made of high quality fine orange mesh to keep out sand flies and still allow the scent of the bait out.

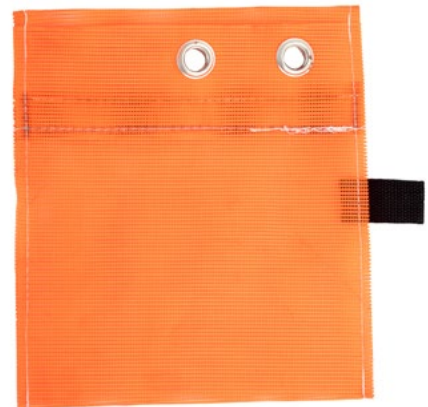

Size (in)		Qty. / Box (pcs)	Price / ea.	Part Number
Length	Width			
10	8	400	4.25	6-BAITBAG

JAR - BAIT



Jar Size (in)		Qty. / Box (pcs)	Price / ea.	Part Number
Height	Width			
4.25	4.25	200	4.79	6-BAITJAR

WASHER - SCALLOP, BLACK



lb / Bag	Price / lb	Part Number
50	4.39	6-SWB

STENHOUSE SLIP

- Material: Steel
- Finish: Hot Dip Galvanized



Size Dia. (in)	I.D. of Ring (in)	Inside Length Arm (in)	Price / ea.	Part Number
1/2	3 1/2	4 1/2	65.45	6-12MMGSS
5/8	3 1/2	4	87.71	6-16MMGSS

ANCHORS

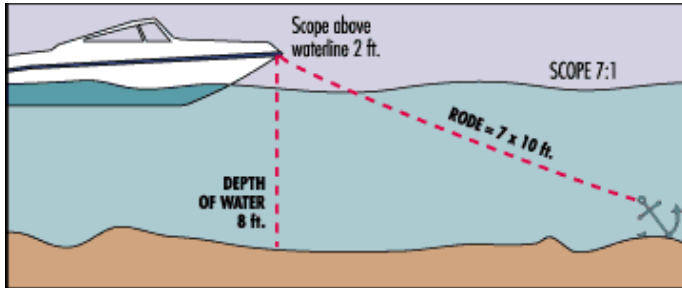

The anchor is the key to effective anchoring or mooring. It is essential to know what to expect from various anchors. Resistance of an anchor to being dragged through a soil has been considered as occurring in two stages: first, biting into the bottom due to the ploughing effects of the flukes, and secondly, maintaining a continuous resistance to drag after it is planted into the bottom.

Holding power type anchors are directly proportional to projected fluke area, and shear strength of the bottom material, and inversely proportional to penetration-area resistance. In many cases a smaller anchor with favorable fluke area to weight ratio is more dependable than a heavier anchor.

Holding power for the two most widely used anchors are as follows:

- Stockless Type anchors in sand develop a holding power to weight ratio of seven to one. In mud it develops three to one. The angle of penetration in both cases is 45°.
- Lightweight Type (Danforth style) anchors in sand develop a holding power to weight ratio of twenty to one, with the angle of penetration being 30°. In mud it develops nine to one with the angle of penetration being 50°.
- The depth of penetration in all preceding cases is compiled from three to seven feet in sand, and from seventeen to twenty feet in mud. All calculations incorporate a 0° scope angle.

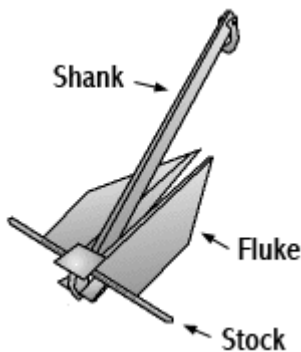

ANCHOR - DANFORTH STYLE / WORKBOAT

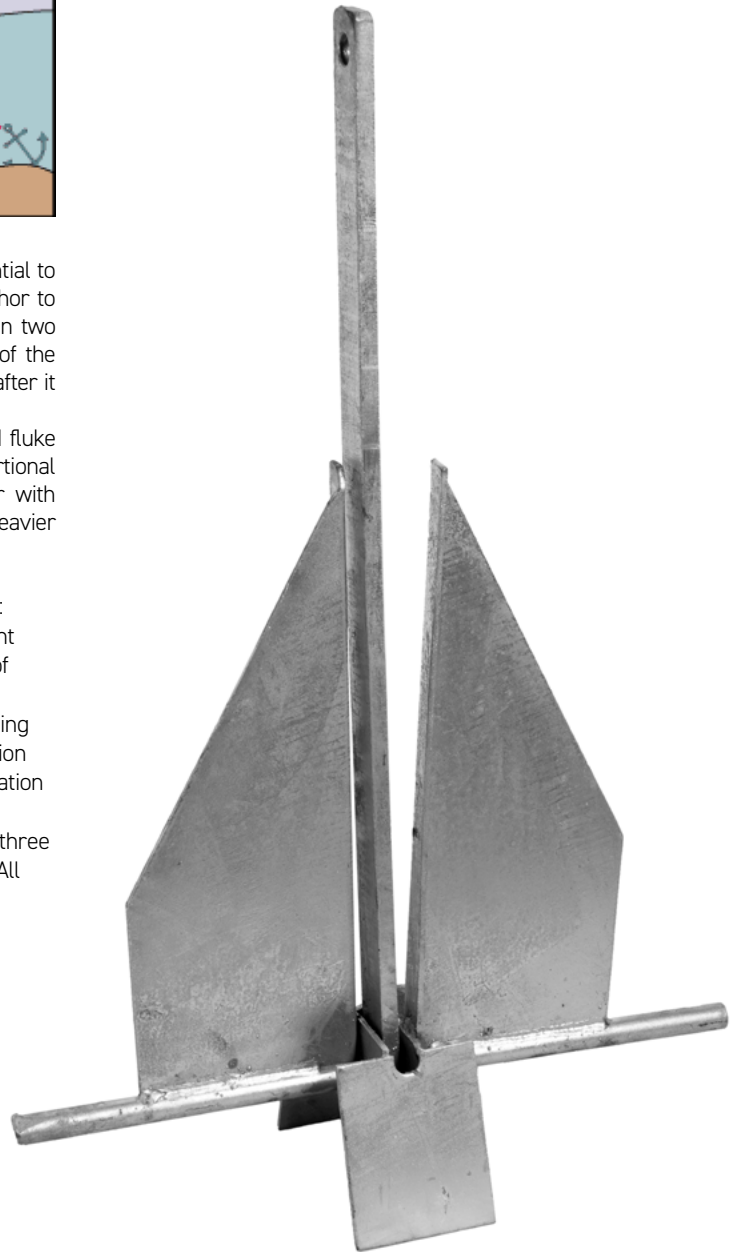

With the "hook" head forcing the flukes to dig in quickly, and the large fluke design providing tremendous holding power; this anchor offers terrific holding power in both sand and mud bottoms.

Weight (lb)	Price / ea.	Part Number
4	34.55	6-ANC4
9	77.75	6-ANC9
13	94.67	6-ANC13
18	131.18	6-ANC18
22	160.21	6-ANC22
44	320.41	6-ANC44
70	1464.92	6-ANC70
100	2093.50	6-ANC100
125	2616.87	6-ANC125
150	3140.25	6-ANC150
200	4187.00	6-ANC200
300	6280.50	6-ANC300
400	8374.00	6-ANC400

Weight (kg)	Dimensions (mm)					
	A	B	C	D	E	F
60	186	408	755	535	985	240
75	200	450	830	590	1080	260
100	216	490	930	640	1180	290
120	220	505	970	670	1230	300
125	234	520	1000	690	1270	310
150	242	550	1060	732	1348	330
200	266	600	1150	810	1490	360
250	294	650	1240	270	1600	390
276	296	660	1250	885	1620	400
300	312	690	1320	925	1700	420
400	342	750	1460	1010	1810	460
500	368	800	1570	1100	2020	490
750	414	910	1800	1260	2300	560
1000	450	980	1980	1380	2540	620
1250	484	1070	2100	1490	2740	670
1500	512	1120	2220	1580	2850	700
2000	560	1130	2440	1730	2910	770
2500	605	1217	2628	1864	3070	830
3000	640	1290	2790	1980	3330	880
4000	700	1420	3070	2170	3590	970
5000	735	1482	3200	2270	3840	1020
6000	800	1620	3500	2480	4100	1100
7000	840	1696	3850	2590	4180	1150
8500	910	1936	3940	2600	4490	1240
10 000	940	2000	4150	2900	4640	1280
13 600	1046	2120	4590	3250	5378	1440
16 000	1105	2240	4845	3435	5680	1520
18 000	1150	2270	5000	3570	5680	1580
20 000	1190	2350	5175	3695	5880	1635
25 000	1280	2530	5570	3982	6330	1760

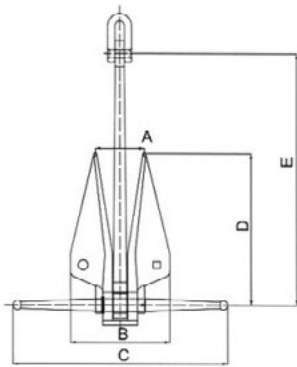

ANCHOR - STOCKLESS

Weight (lb)	Price / ea.	Part Number
100	2093.50	6-ANCSTK100
150	3140.25	6-ANCSTK150
200	4187.00	6-ANCSTK200
250	5233.75	6-ANCSTK250
300	6280.50	6-ANCSTK300
500	10467.50	6-ANCSTK500

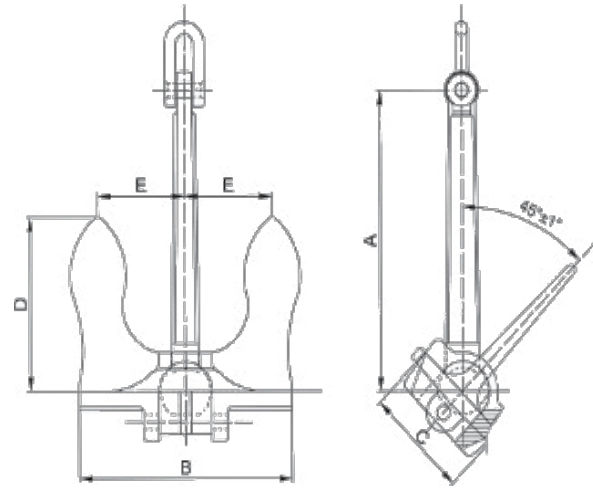

Weight (kg)	Dimensions (mm)				
	A	B	C	D	E
200	685	457	241	366	190.5
300	812	590	296	442	230
400	812	654	330	482	250
500	900	673	356	530	287.5
750	965	770	407	584	308
1000	1067	854	457	640	347.5
1250	1165	923	475	720	370
1500	1232	1005	515	748	392
2000	1370	1092	558	848	430
2100	1370	1092	558	848	436
2500	1473	1136	568	848	448
3000	1625	1194	648	912	483
3500	1625	1340	698	1003	500
4000	1734	1354	705	1054	518
4500	1794	1440	735	1066	563
5000	1930	1460	762	1130	588
6000	1930	1613	844	1194	641.5
6300	1930	1613	844	1194	641.5
7000	2082	1691	882	1263	668

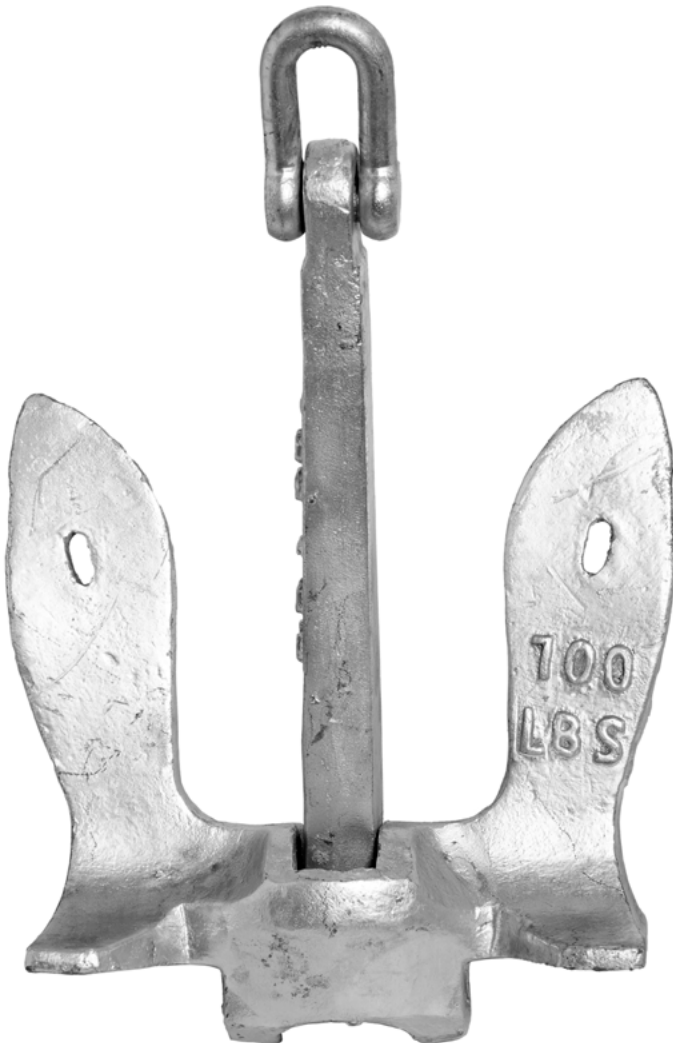

ANCHOR - DELTA HHP



Weight (kg)	Dimensions (mm)						P.L. (kN)
	TL	W	F	H	S	D1	
300	1380	1200	960	465	1080	45	98
500	1725	1500	1200	570	1350	48	143
750	1950	1700	1360	650	1530	50	198
1000	2150	1870	1500	710	1680	62	250
1500	2460	2140	1710	815	1920	70	350
2000	2715	2360	1890	900	2125	75	435
2500	2925	2540	2035	970	2290	80	510
3000	3105	2700	2160	1030	2430	90	576
3500	3240	2845	2280	1087	2565	90	635
4000	3375	2953	2315	1140	2650	100	686
5000	3658	3200	2560	1225	2900	110	776
6000	3935	3405	2720	1310	3125	110	875
7000	4120	3580	2860	1360	3220	117	968
7500	4215	3666	2925	1390	3295	124	1005
8000	4315	3750	3000	1425	3380	130	1048
9000	4490	3874	3120	1480	3512	135	1108
10000	4725	4100	3280	1560	3690	140	1172
11000	4868	4140	3310	1600	3750	145	1238
12000	4960	4275	3420	1640	3860	150	1300
13500	5120	4450	3560	1700	4000	155	1408
15000	5345	4600	3685	1735	4160	160	1520
18000	5678	4890	3919	1840	4418	170	1710
20000	5880	5065	4050	1900	4570	175	1840

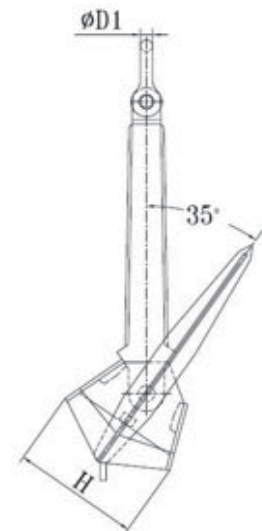
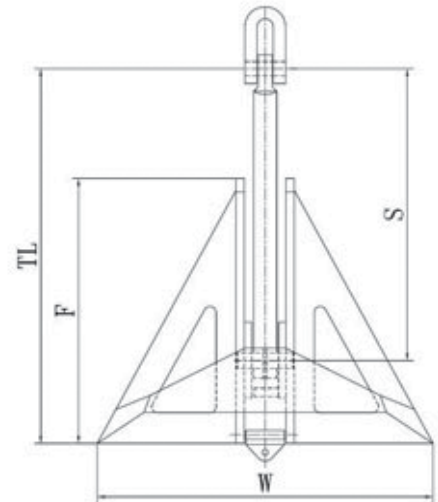

ANCHOR - AC-14

Weight (kg)	Dimensions (mm)							
	A	B	C	D	E	F	G	H
56	612	298	376	555	109	170	115	24
100	745	364	458	675	130	200	130	28
180	909	442	558	822	162	252	160	36
300	1075	524	660	975	194	298	192	45
428	1213	590	745	1098	216	336	215	48
675	1410	690	868	1278	250	390	255	60
750	1450	700	878	1315	256	396	255	60
910	1560	760	957	1410	273	430	255	60
970	1592	775	978	1445	284	440	280	62
1080	1650	805	1014	1495	294	455	280	62
1305	1760	858	1082	1595	313	485	310	68
1440	1818	885	118	1645	324	505	310	68
1710	1925	940	1184	1745	343	532	340	74
1845	1975	965	1215	1785	347	546	340	74
2100	2065	1005	1268	1865	354	570	380	82
2475	2175	1062	1340	1970	385	570	380	82
2835	2265	1105	1393	2055	399	625	410	90
3550	2455	1198	1508	2225	438	680	415	100
3940	2540	1240	1562	2300	453	705	450	100
4500	2655	1295	1632	2405	473	735	450	100
4840	2720	1330	1670	2465	490	755	480	110
5610	2858	1396	1758	2590	509	790	500	110
Weight (kg)	Dimensions (mm)							
	A	B	C	D	E	F	G	H
6000	2922	1426	1796	2646	515	810	500	110
6900	3062	1496	1884	2775	545	848	540	117
7800	3190	1558	1962	2890	569	884	600	130



ANCHOR - AC-14

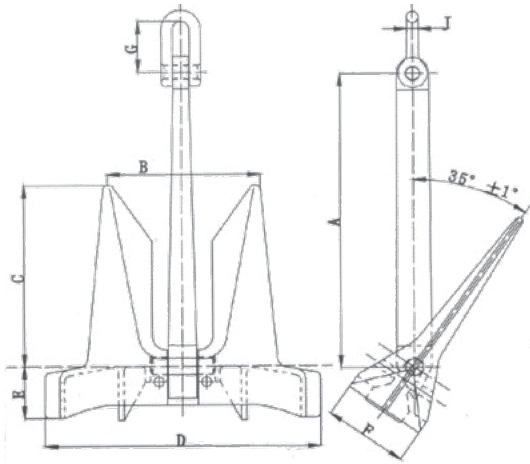

8300	3256	1590	2002	2950	574	902	600	130
9300	3382	1652	2080	3064	603	936	630	135
9900	3452	1686	2124	3128	616	956	640	140
10575	3523	1720	2166	3192	628	976	660	145
11100	3589	1720	2166	3192	628	976	660	145
11700	3650	1782	2245	3308	648	1010	680	150
12300	3683	1794	2260	3330	655	1018	700	155
12900	3772	1842	2320	3418	670	1044	700	155
13500	3830	1870	2355	3470	682	1060	730	160
14100	3885	1896	2389	3520	689	1076	730	160
14700	3940	1924	2423	3570	700	1090	730	160
15400	4002	1954	2461	3626	710	1108	730	160
16100	4062	1982	2498	3680	721	1125	770	170
16900	4128	2016	2538	3740	721	1144	770	170
17800	4200	2050	2583	3806	725	1162	800	180
18800	4277	2088	2630	3875	729	1185	800	180
20000	4350	2101	2694	3945	729	1185	820	199
25000	5046	2437	3125	4577	846	1375	848	230

ANCHOR - ST OFFSHORE

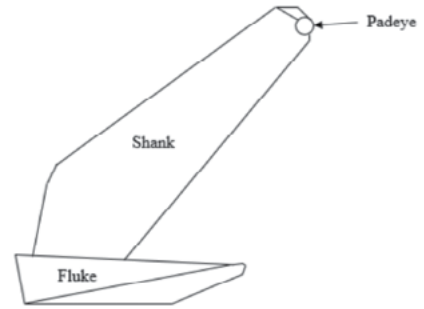

Weight (kg)	Dimensions (mm)									
	A	B	C	D	E	F	G	H	L	N
500	2050	2191	1242	48	187	859	323	1002	215	64
1000	2580	2755	1563	59	236	1081	407	1261	271	78
1500	2957	3160	1792	68	270	1240	467	1446	310	94
2000	3253	3477	1970	74	297	1364	513	1591	340	106
3000	3722	3979	2256	90	340	1561	586	1820	385	120
4000	4096	4378	2483	100	374	1717	645	2003	415	124
5000	4415	4718	2678	110	403	1853	696	2161	480	136
6000	4691	5013	2845	110	428	1968	739	2296	500	144
7000	4939	5277	2994	115	451	2071	778	2416	540	156
7500	5053	5399	3063	124	461	2119	796	2472	580	156
8000	5166	5519	3134	130	471	2169	816	2530	600	156
9000	5372	5739	3239	135	490	2255	848	2631	620	170
10000	5563	5943	3375	140	508	2335	878	2725	640	170
11000	5742	6134	3483	145	524	2410	906	2812	660	184
12000	5914	6318	3588	150	539	2483	935	2897	680	184
13500	6150	6570	3731	155	561	2582	972	3012	700	188
15000	6369	6804	3864	160	581	2674	1006	3119	730	198
18000	6767	7229	4105	175	618	2841	1065	3313	790	212
20000	7011	7490	4255	180	640	2946	1107	3435	800	216
22000	7237	7731	4391	190	660	3040	1142	3545	850	226
25000	7551	8066	4581	195	689	3171	1191	3699	860	230
30000	8023	8570	4866	210	733	3282	1264	3929	940	244

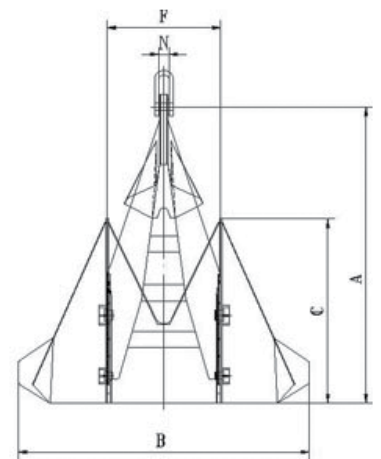
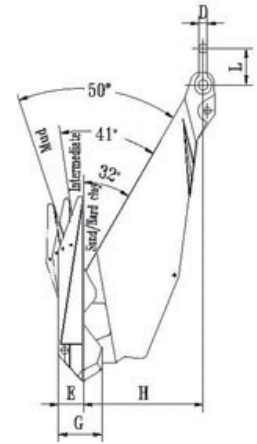

ANCHOR - STS OFFSHORE

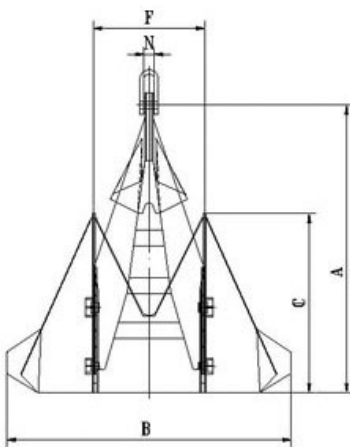
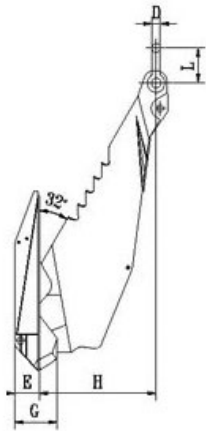

Weight (kg)	Dimensions (mm)									
	A	B	C	D	E	F	G	H	L	N
500	2034	2175	1232	48	187	849	317	992	215	64
1000	2564	2742	1553	59	236	1071	401	1251	271	78
1500	2933	3136	1776	68	270	1224	457	1430	310	94
2000	3229	3453	1955	74	297	1348	503	1575	340	106
3000	3698	3955	2240	90	340	1545	576	1804	385	120
4000	4072	4354	2467	100	374	1701	635	1987	415	124
5000	4385	4688	2654	110	403	1829	684	2137	480	136
6000	4661	4983	2821	110	428	1944	727	2272	500	144
7000	4909	5247	2970	115	451	2047	766	2392	540	156
7500	5023	5369	3039	124	461	2095	784	2448	580	156
8000	5130	5483	3104	130	471	2139	800	2500	600	156
9000	5336	5703	3209	135	490	2225	832	2601	620	170
10000	5527	5907	3345	140	508	2305	862	2695	640	170
11000	5706	6098	3453	145	524	2380	890	2782	660	184
12000	5870	6274	3552	150	539	2447	913	2861	680	184
13500	6106	6526	3695	155	561	2546	950	2976	700	188
15000	6325	6760	3828	160	581	2638	984	3083	730	198
18000	6723	7185	4069	175	618	2805	1043	3277	790	212
20000	6961	7440	4211	180	640	2902	1077	3391	800	216
22000	7187	7681	4347	190	660	2996	1112	3501	850	226
25000	7501	8016	4537	195	689	3127	1161	3655	860	230
30000	7973	8520	4822	210	733	3238	1234	3885	940	244

ANCHOR - DEAD WEIGHTS

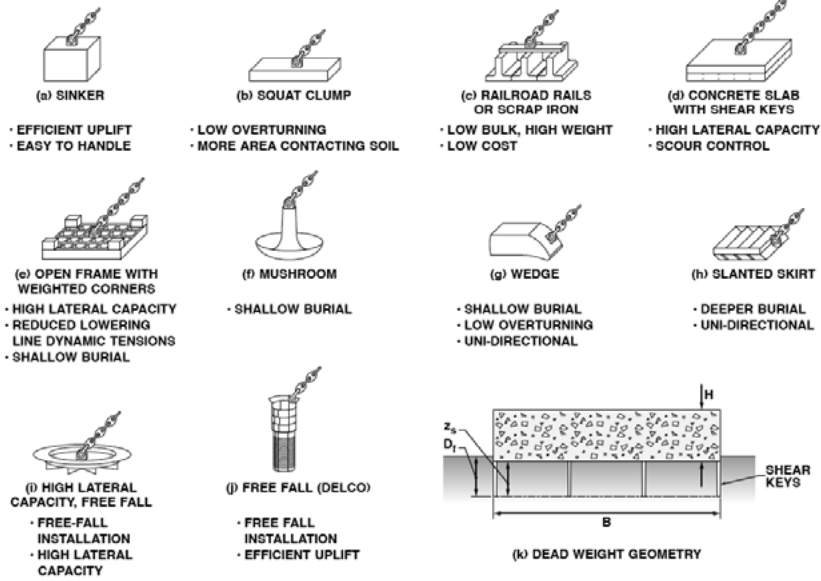

Flipper Delta



Bruce Mk4 Twin Shank



AC 14



Hall



Stockless



Danforth



Suction type anchors.

ANCHORS

Anchors are available to 65,000 kg in weight. Measurements are holding capacity charts can be supplied. Selecting the correct anchor is dependent on the application. The water depth, soil conditions,

holding power line ratios, distance to penetration/burial and installation methods all have to be considered when selecting the style and weight to be used.

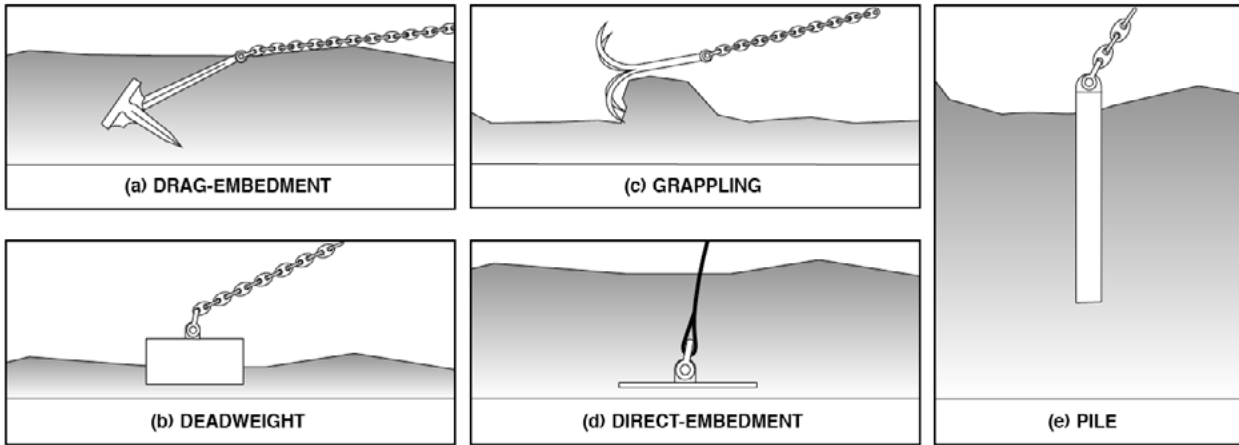

Below are a list of the most common drag embedment type anchors used, they are usually used for temporary moorings or as an anchoring point for pulling systems.

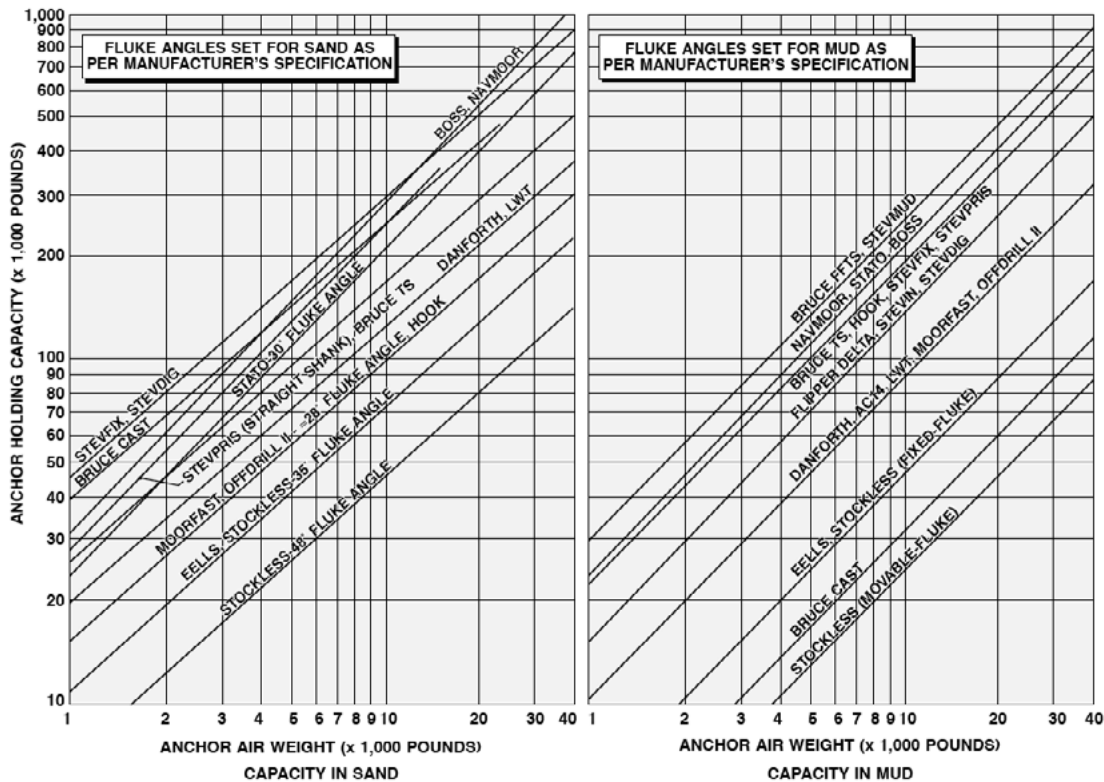

TUNING FORK - GN®

- Material: High tensile steel
- Finish: Painted
- Design Factor: 4:1
- Temperature Range: -20°C up to +200°C
- Certification: Certificate of Conformity (on request)
- Rated in Metric Ton(s)

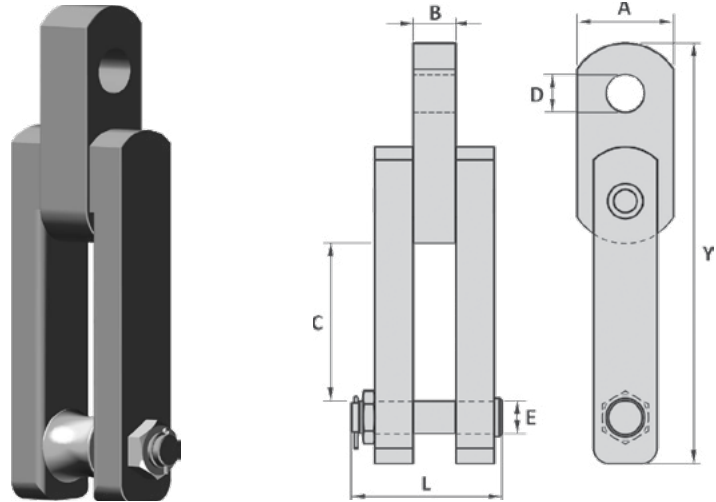

Tolerance: Forged parts ± 5%, machined parts ± 1 mm

Chain (in)	WLL (ton)	Dimensions (mm)							Weight (kg)	Price
		A	B	C	D	E	L	Y		
2 1/2	55	170	75	280	75	60	255	768	100	Pricing on Request
2 3/4	85	210	85	300	85	60	290	863	148	
3	110	240	100	330	98	70	384	927	221	
3 1/4	110	240	100	360	98	70	384	957	237	
3 1/2	120	250	110	390	98	85	391	1047	301	
3 3/4	120	250	110	410	98	85	391	1091	315	
4	150	280	120	440	115	90	421	1262	433	
4 1/4	180	320	130	470	130	95	496	1325	543	
4 1/2	200	330	140	490	130	100	510	1385	629	
4 3/4	225	350	150	520	145	105	540	1447	714	

HOOK - PELICAN SLIPHOOK, GN®



- Material: High tensile steel
- Finish: Painted
- Design Factor: 5:1
- Temperature Range: -20°C up to +200°C
- Certification: Certificate of Conformity (on request)
- Rated in Metric Ton(s)
- Non-standard sizes or custom products available on request.

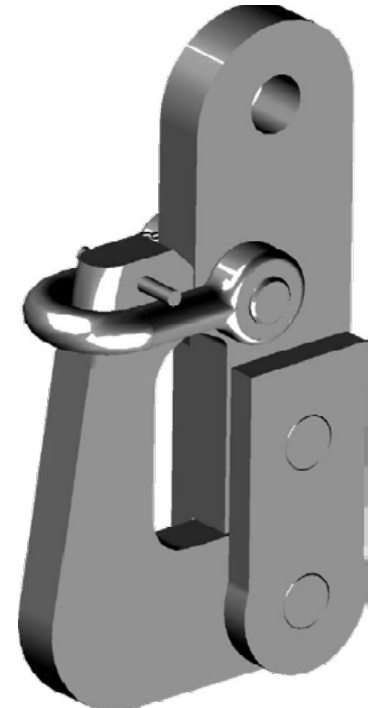
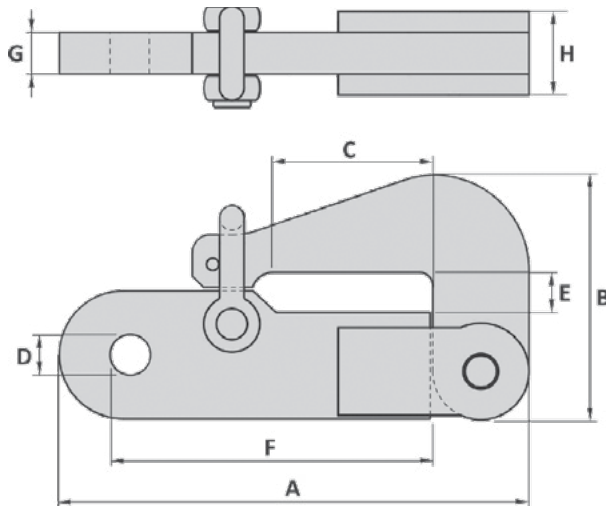

WLL (ton)	MBL (ton)	Dimensions (mm)								Wt. (kg)	Price
		A	B	C	D	E	F	G	H		
3.5	17.5	328	155	85	26	35	240	20	54	6.7	Pricing on Request
5	25	338	161	100	38	35	234	30	60	12	
8	40	415	200	150	50	55	300	30	70	17	
12.5	62.5	491	235	160	55	65	358	35	75	26	
17	85	550	265	165	55	70	390	45	95	45	
25	125	610	308	180	60	76	430	45	105	62	
35	175	670	355	200	60	85	465	50	110	100	
55	275	775	410	230	75	90	500	60	130	152	
85	425	1020	490	310	103	110	704	100	200	352	
120	600	1240	650	418	105	160	858	100	220	524	
150	750	1308	710	482	115	180	919	100	240	616	
200	1000	1477	790	550	130	200	1017	120	280	702	

Tolerance: Forged parts ± 5%, machined parts ± 1 mm

HOOK - CHAIN GRAPNEL

- Material: Forged Steel
- Finish: Painted/Self coloured
- Design Factor: 4:1
- Temperature Range: -20°C up to +200°C
- Certification: Certificate of Conformity (on request)
3.1 material certificate EN 10204 (on request)
- Rated in Matric Ton(s)

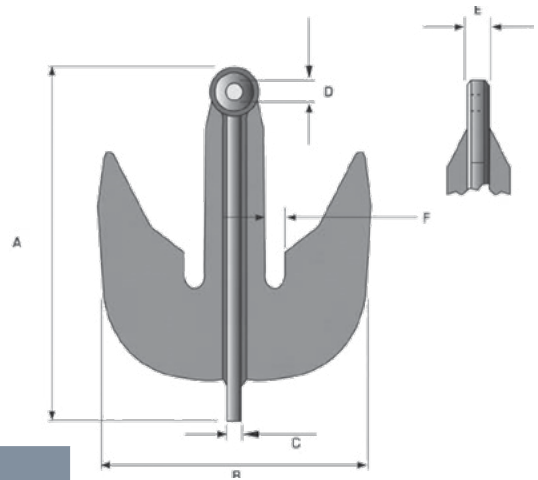

WLL (t)	PL (t)	Dimensions (mm)						Wt./ea. (kg)	Price
		A	B	C	D	E	F		
100	150	1178	1372	75	98	135	108	1351	Pricing on Request
200	270	1822	1499	90	114	130	108	1850	
250	350	2630	1994	1676	100	144	190	127	

Tolerance: ± 5%

HOOK - J, CHAIN CHASER

- Material: Mild Steel
- Finish: Painted
- Temperature Range: -20°C up to +200°C
- Certification: Certificate of Conformity (on request)
3.1 material certificate EN 10204 (on request)
- Rated in Matric Ton(s)

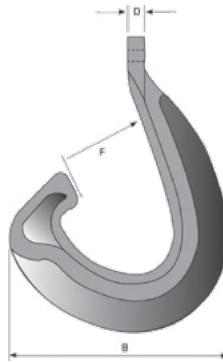

WLL (t)	PL (t)	Dimensions (mm)						Wt./ea. (kg)	Price
		A	B	C	D	E	F		
100	250	2438	1829	305	124	86	699	1886	Pricing on Request
250	400	2573	2185	457	178	144	699	3400	

Tolerance: ± 5%



HOOK - J, CHAIN CHASER

- Material: Mild Steel
- Finish: Painted
- Temperature Range: -20°C up to +200°C
- Certification: Certificate of Conformity (on request)
3.1 material certificate EN 10204 (on request)
- Rated in Matric Ton(s)

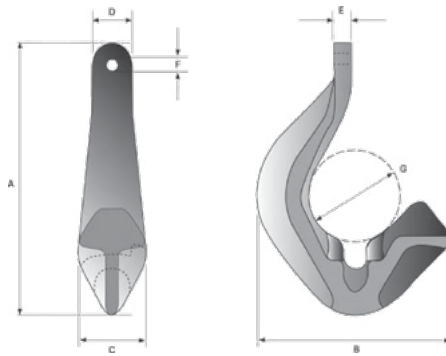

WLL (t)	PL (t)	Dimensions (mm)							Wt./ea. (kg)	Price
		A	B	C	D	E	F	G		
100	250	2083	1486	533	305	124	86	711	1752	Pricing on Request
250	400	2350	1824	533	406	178	144	711	3000	



HOOK - PERMANENT CHAIN CHASER

- Material: Mild Steel
- Finish: Painted
- Temperature Range: -20°C up to +200°C
- Certification: Certificate of Conformity (on request)
3.1 material certificate EN 10204 (on request)
- Rated in Matric Ton(s)

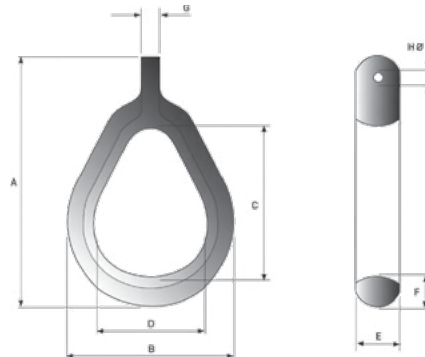

WLL (t)	PL (t)	Dimensions (mm)							Wt./ea. (kg)	Price
		A	B	C	D	E	F	G		
100	250	2083	1486	533	305	124	86	711	1752	Pricing on Request
250	400	2350	1824	533	406	178	144	711	3000	



WLL (t)	
100	Designed for use with 64 mm to 90mm chain
250	Designed for use with 95 mm to 120 mm chain

HOOK - RING CHASER

- Material: Forged Steel
- Finish: Painted/Self coloured
- Design Factor: 4:1
- Temperature Range: -20°C up to +200°C
- Certification: Certificate of Conformity (on request)
- 3.1 material certificate EN 10204 (on request)
- Rated in Metric Ton(s)

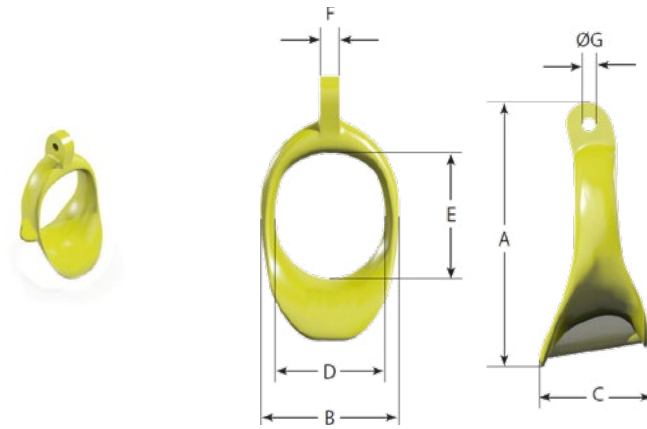

WLL (t)	PL (t)	Dimensions (mm)							Wt./ea. (kg)	Price
		A	B	C	D	E	F	G		
150	300	1700	841	720	711	801	125	100	950	Pricing on Request

Tolerance: ± 5%

HOOK - DUAL CHASER RING

- Material: Forged Steel
- Finish: Painted/Self coloured
- Design Factor: 4:1
- Temperature Range: -20°C up to +200°C
- Certification: Certificate of Conformity (on request)
- 3.1 material certificate EN 10204 (on request)
- Rated in Metric Ton(s)

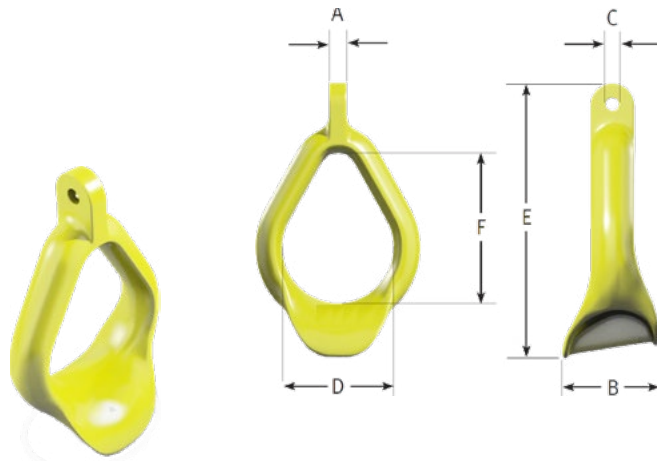

WLL (t)	PL (t)	Dimensions (mm)							Wt./ea. (kg)	Price
		A	B	C	D	E	F	G		
150	300	1700	841	720	711	801	125	100	950	Pricing on Request

Tolerance: ± 5%

FENDER - CYLINDRICAL FENDERS

- Applicable for ships of different sizes, easy installation.
- Low reaction forces.
- Little surface pressure.

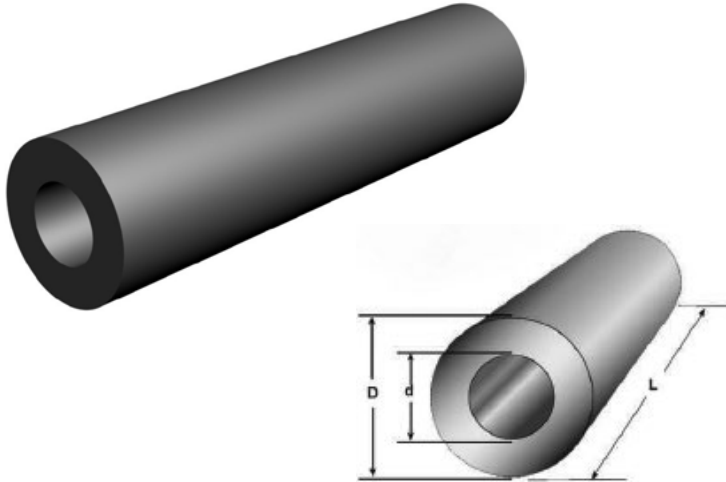

Weight (kg)	Dimensions (mm)		
	L	D	d
Y150	500-5500	150	75
Y200	500-5500	200	100
Y250	500-5500	250	125
Y300	500-5500	300	150
Y400	500-5500	400	200
Y500	500-5500	500	250
Y600	500-5500	600	300
Y700	500-5500	700	350
Y800	500-5500	800	400
Y900	500-5500	900	450
Y1000	500-5500	1000	500
Y1100	500-5500	1100	550
Y1200	500-5500	1200	600
Y1400	500-5500	1400	700
Y1600	500-5500	1600	800

FENDER - SEMI-CIRCULAR FENDERS

Model	Dimensions (mm)								n (Fastening Points)
	L	A	D	d	B	H	h	P	
D200H	1000	200	55	28	200	200	30	600	3
D200H	1500	150	55	28	200	200	30	600	3
D200H	2000	250	55	28	200	200	30	500	4
D300H	900	150	65	32	300	300	40	600	2
D300H	1000	200	65	32	300	300	40	600	2
D300H	1500	150	65	32	300	300	40	600	3
D300H	2000	250	65	32	300	300	40	500	5
D300H	1000	200	65	32	360	300	40	600	2
D300H	1500	150	65	32	360	300	40	600	3
D400H	1500	150	65	32	400	400	55	400	4
D400H	2000	200	65	32	400	400	55	400	5
D500H	1000	150	55	28	500	500	60	350	3X2
D500H	1500	150	55	28	500	500	60	400	4X2
D500H	2000	200	55	28	500	500	60	400	5X2

- Suitable reaction force and energy absorption, low weight and easy for installation and maintenance. Applicable for frame dock due to smaller bottom width.

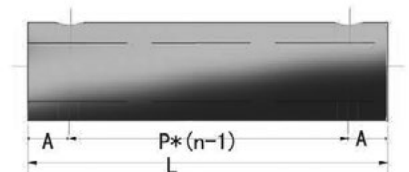
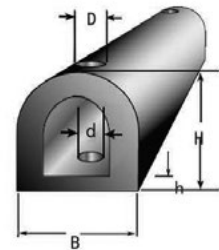

FENDER - PNEUMATIC FENDER

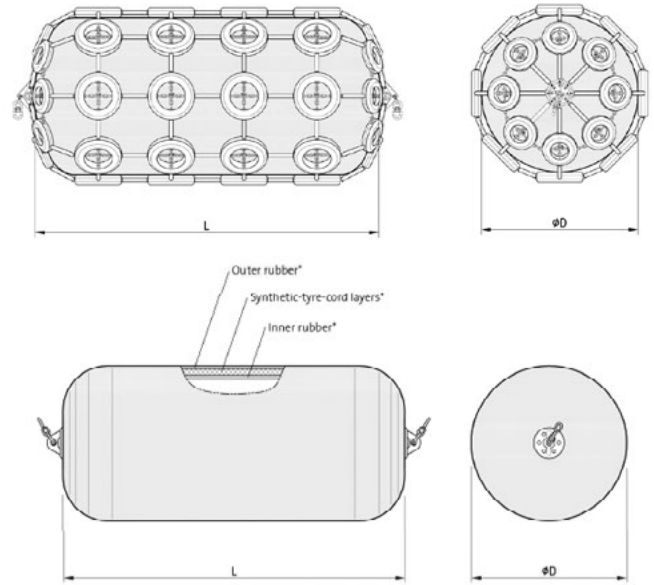
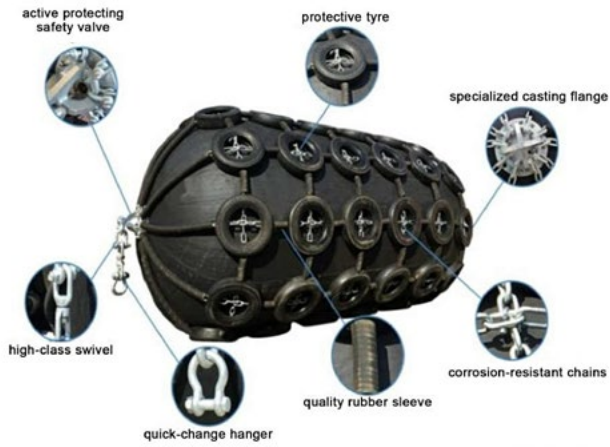

Fender Size D x L [mm]	Initial Pressure 0.5 kg/cm ²			Initial Pressure 0.8 kg/cm ²			Weight		
	Guaranteed energy absorption (GEA) [kNm]	Reaction force at GEA deflection [kN]	Hull pressure at GEA deflection [kN/m ²]	Guaranteed energy absorption (GEA) [kNm]	Reaction force at GEA deflection [kN]	Hull pressure at GEA deflection [kN/m ²]	Fender Body [kg]	Chain Net [kg]	Total [kg]
500 x 1,000	6	64	132	8	85	174	25	55	80
600 x 1,000	8	74	126	11	98	166	30	65	95
700 x 1,500	17	137	135	24	180	177	45	100	145
1,000 x 1,500	32	182	122	45	239	160	60	110	170
1,000 x 2,000	45	257	132	63	338	174	75	150	225
1,200 x 2,000	63	297	126	88	390	166	110	180	290
1,350 x 2,500	102	427	130	142	561	170	170	210	380
1,500 x 3,000	153	579	132	214	761	174	220	400	620
1,700 x 3,000	191	639	128	267	840	168	250	520	770
2,000 x 3,500	308	875	128	430	1,150	168	360	670	1,030
2,500 x 4,000	663	1,381	137	925	1,815	180	650	830	1,480
2,500 x 5,500	943	2,019	148	1,317	2,653	195	860	1,050	1,910
3,300 x 4,500	1,175	1,884	130	1,640	2,476	171	1,100	1,600	2,700
3,300 x 6,500	1,814	3,015	146	2,532	3,961	191	1,660	2,300	3,960
3,300 x 10,600	3,067	5,257	158	4,281	6,907	208	3,000	4,700	7,700
4,500 x 9,000	4,752	5,747	146	6,633	7,551	192	3,800	3,680	7,480
4,500 x 12,000	6,473	7,984	154	9,037	10,490	202	7,000	8,570	15,570

FENDER - FOAM FILLED FENDER TYPE & STRUCTURE

• Dock Protection Colorful Fender, also called EVA solid fender, is a new type of fender using light weight high elasticity foam as cushion medium, widely applied to harbor, off-shore, STS and STD operation.

• Hanger Foam Filled Solid Fender is made of environmental protection material and high elasticity polymeric material. Long service life and high economic value of this product is achieved by the high quality material with performance of high strength, high elasticity, high adhesion, anti-leakage, and aging resistance.

Foam Filled Fender Type & Structure

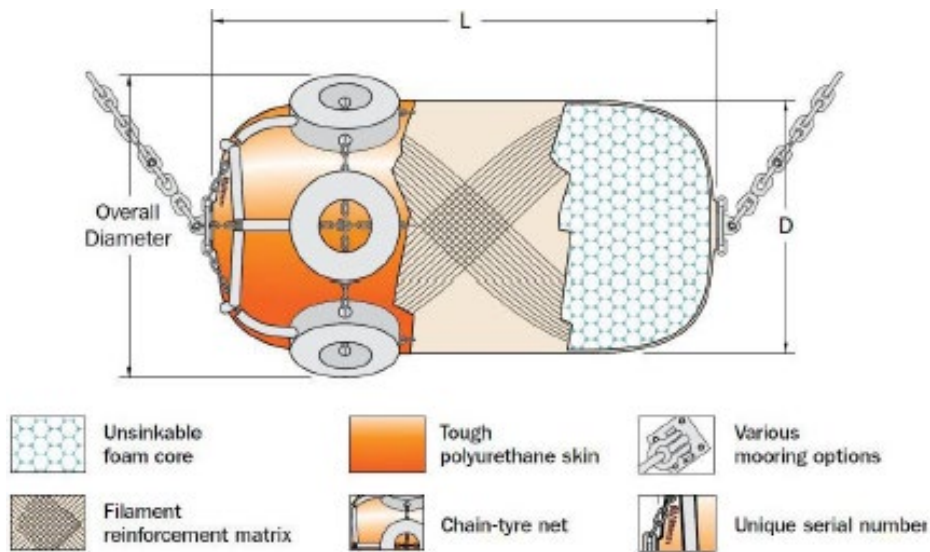

Type I fender with tire-chain protective sleeve



- Inside of Foam Filled Solid Fender is filled with environmental protection material-EVA with coating protective layer of polyurea material on outer surface. Polyurea is a new material of adjustable high-elasticity modulus. There are a galvanized flange and swivel on the fender two ends. Like pneumatic rubber fender, tire-chain net protective jacket is also optional spare part to Dock Protection Colorful Fender for better anti-collision performance.

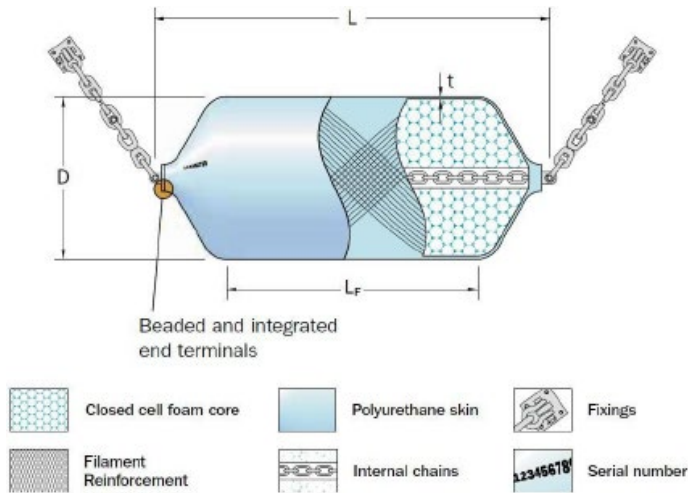

Foam Fender Performance		
Size Diameter x Length [mm]	At 60% Deflection	
	Energy Absorption [kJm]	Force Reaction [kN]
500 x 1000	8	71
600 x 1000	12	86
700 x 1500	27	161
1000 x 1500	49	205
1000 x 2000	64	274
1200 x 2000	93	337
1200 x 2400	110	390
1350 x 2500	145	463
1500 x 3000	216	624
1700 x 3000	273	696
2000 x 3500	456	990
2000 x 4000	505	1110
2200 x 4500	697	1396
2500 x 4000	781	1386
2500 x 5000	985	1750
3000 x 5000	1410	2050
3000 x 6000	1695	2460
3300 x 6500	2245	2950
4500 x 9000	7660	19650

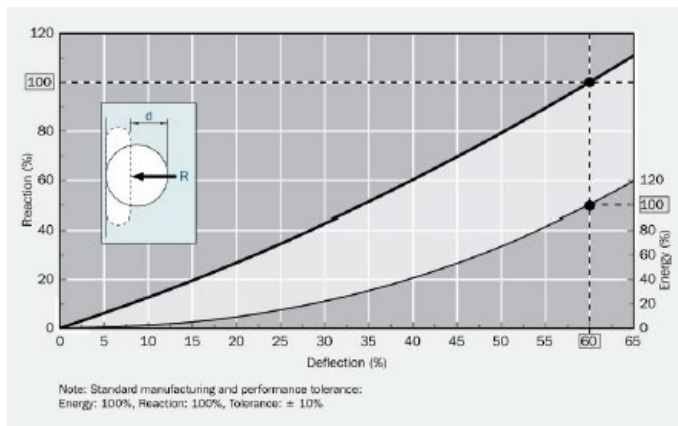

FENDER AND BUOYANCY



Anchor Pendant Buoyancy (APB)



Ancillary Buoyancy

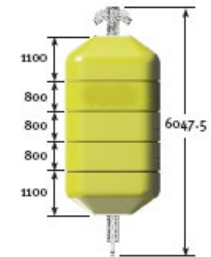
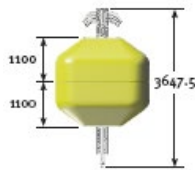

Surface/Sub-Surface Modular Buoyancy



Dock Fenders

FENDER FOAM IONOMER, GILMAN CORPORATION



Gilman Ionomer fenders are made from continuous extruded sheets with thick walled closed cell material. This material has the unique ability to link ionically between neighboring molecular chains with the same bond as the polymer itself. The surface is tough yet smooth and flexible: solid ionomer plastic is the primary material used for the covers of golf balls and bowling pins. These fenders offer superior strength, energy absorption and compression resistance and unsurpassed functional integrity in an almost infinite variety of shapes and sizes from buoys to ski barriers.

Benefits of intergral Ionomer Foam Fendering

- More Energy Absorption in smaller sizes
- Low-Hysteresis Reaction forces
- Low weight/high Buoyancy
- High-Density Skin
- Unsurpassed Functional Integrity
- Proven Effectiveness
- Impervious to Fuels and chemicals/ oil spills
- Non-toxic/Fire Safety
- Highly water repellent
- Unaffected by Cold
- No Dissimilar materials
- Easy to repair
- High Visibility
- Non Marking/non-abrasive
- Damage Control
- Fully Repairable
- Design Flexibility



FENDER FOAM IONOMER, BERTHING ENERGY AND REACTION FORCES

Fender Size Diameter (ft) x Length (ft)	Berthing Energy (ft-kips)	Reaction Force (kips)
2 x 3	15	35
2 x 4	20	45
2 x 6	30	70
2 x 8	40	90
3 x 6	70	105
3 x 8	90	140
3 x 10	115	175
3 x 12	140	210
3 x 14	160	245
4 x 8	165	185
4 x 10	205	235
4 x 12	250	280
4 x 14	290	325
4 x 16	330	375
4 x 20	415	465
5 x 10	325	290
5 x 12	390	350
5 x 14	450	410
5 x 16	515	465
5 x 18	580	545
5 x 20	645	585
6 x 12	560	420
6 x 14	650	490
6 x 16	745	560
6 x 18	835	630
6 x 20	930	700



Assumptions:

- Fender size is expressed as diameter (in feet) by length overall (in feet)
- Rated berthing energy and reaction force are based on fender performance at 60% compression ratio
- Berthing energy and reaction force values for the 2 x 6 fender are based on testing performed in 1993. The berthing energy and reaction forces for the other fenders in this table were scaled from the nominal tested fender results using equations (11) and (12) from ASTM F2192-02

FAIRLEAD ROLLER - ANCHOR

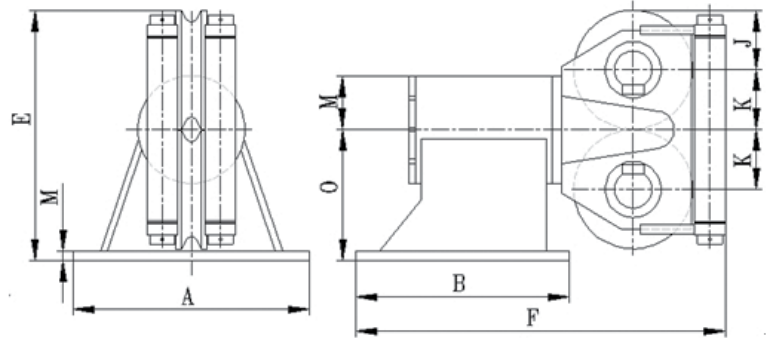

Wire Rope Dia. (mm)	Sheave Dia. (mm)	Dimensions (mm)								
		A	B	E	F	J	K	M	N	O
25	254	356	356	530	680	127	129	20	114	275
32	305	660	505	665	890	152	154	32	124	360
38	406	760	760	867	1280	203	205	38	178	460
44	508	1016	915	1070	1485	254	256	45	220	560
52	610	1220	1068	1265	1792	305	307	48	265	650
64	762	1420	1370	1565	2080	381	383	60	325	800

FAIRLEAD ROLLER - TYPE A

Nominal Dia. (mm)	Dimensions (mm)				
	Φ	Φ 1	Φ 2	H	C
150	150	216	240	137	5
200	200	280	310	157	5
250	250	350	380	177	6
300	300	400	440	197	7
350	350	460	500	217	7
400	400	520	560	237	7
450	450	590	630	257	7
500	500	660	700	277	7

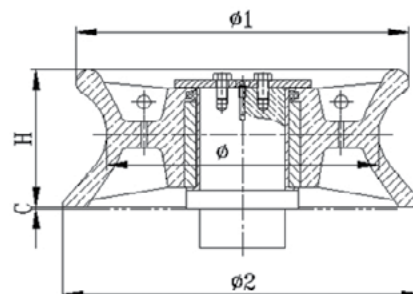

FAIRLEAD ROLLER - JIS F2014

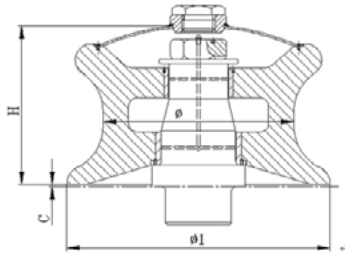

Nominal Dia. (mm)	Weight (kg)	Dimensions (mm)			
		Φ	Φ 1	H	C
100	18	100	170	140	3
150	32.1	150	240	195	3
200	64.6	200	310	235	3
250	108	250	380	282	4
300	159	300	440	305	4
350	235	350	500	330	4
400	336	400	560	355	5

FAIRLEAD ROLLER - UNIVERSAL

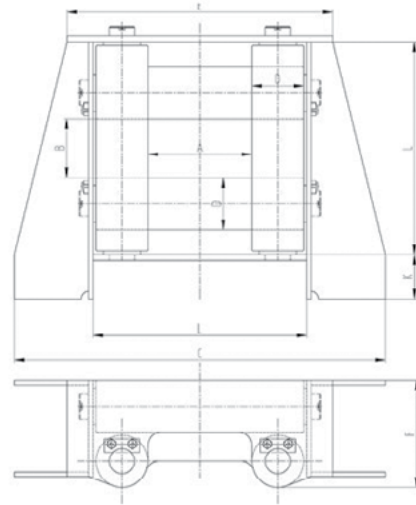

Type	Rope Dia. (mm)	Dimensions (mm)								Mass (kg)
		A	B	C	D	E	F	K	L	
FA4-12	12	180	100	650	80	446	170	80	356	75
FA4-16	16	230	130	800	100	546	210	100	446	130
FA4-20	20	250	130	900	120	626	250	120	506	220
FA4-24	24	280	160	1000	140	716	288	120	576	330
FA4-32	32	300	160	1200	180	836	366	140	676	580
FA4-40	40	320	180	1350	245	1030	500	180	830	1100
FA4-48	48	400	250	1700	300	1236	608	200	1016	2210

CHOCK - BULWARK MOUNTING, JIS F2017-BC



Nominal No.	Weight (kg)	Dimensions (mm)			
		L	L2	H2	H3
310	276	310	734	684	462
360	305	360	788	688	464
400	344	400	832	692	470
450	385	450	886	696	474
500	422	500	940	700	478

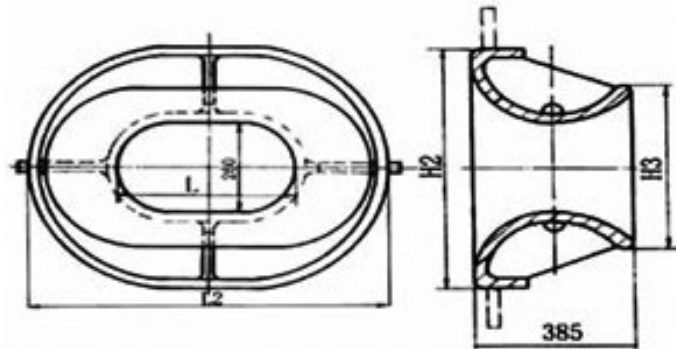

CHOCK - BULWARK MOUNTING, JIS F2030-A

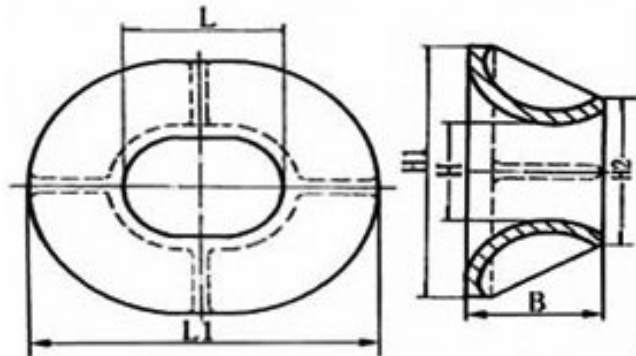

Nominal No.	Dimensions (mm)					Weight (kg)
	L	L1	H	H1	B	
400	400	780	300	680	350	210
500	500	940	400	840	400	340
600	600	1100	450	950	450	490
700	700	1260	500	1060	500	600
800	800	1420	600	1220	550	880

CHOCK - BULWARK MOUNTING, BOW, TYPE EU

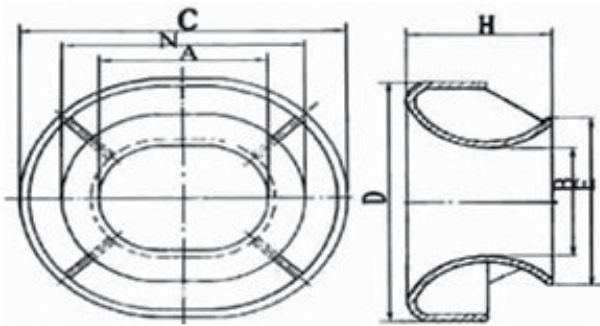

Nominal No.	Dimensions (mm)							Weight (kg)
	A	B	C	D	E	H	N	
315 x 250	315	250	695	630	432	342	497	198
425 x 280	425	280	925	780	516	450	661	358
600 x 315	600	315	1160	875	571	504	866	547
600 x 450	600	450	1160	1010	706	504	866	629
800 x 600	800	600	1360	1160	1060	504	1260	813

CHOCK - MOUNTING, TYPE EU

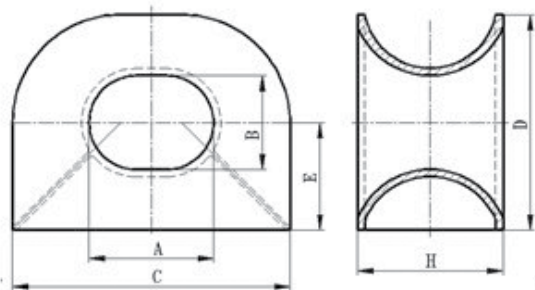

Nominal No.	Dimensions (mm)						Weight (kg)
	A	B	C	D	E	H	
315 x 250	315	250	815	620	365	380	230
425 x 280	425	280	1075	785	450	500	378
600 x 315	600	315	1360	865	507	560	598
600 x 450	600	450	1360	1000	575	560	655
600 x 450	600	450	1560	1200	675	760	780

SHEAVE - VERTICAL LEAD



Wire Size		Sheave Dia. (mm) D	Dimensions (mm)				
mm	in		A	B	C	E	F
25	1	406	485	276	520	20	220
32	1-1/4	508	603	345	610	25	275
38	1-1/2	600	711	407	700	30	330
44	1-3/4	660	782	448	770	30	390
52	2	762	903	517	900	40	410
58	2-1/4	830	870	580	980	40	440
64	2-1/2	914	1083	620	1070	40	490
76	3	1260	1320	700	1450	50	670
83	3-1/4	1330	1410	760	1560	50	720

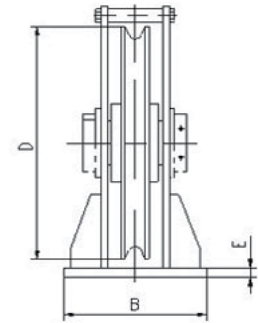
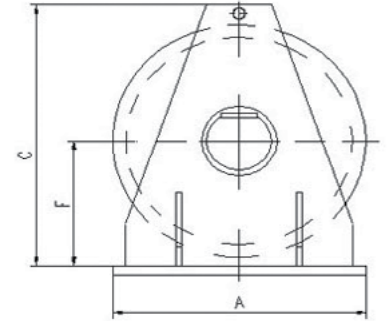

SHEAVE - HORIZONTAL LEAD



Wire Size		Sheave Dia. (mm) D	Dimensions (mm)			
mm	in		A	B	C	E
25	1	406	635	635	90	190
32	1-1/4	508	787	787	102	210
38	1-1/2	610	914	914	110	230
44	1-3/4	660	1016	1016	120	250
52	2	762	1143	1143	130	270
58	2-1/4	850	1250	1250	140	280
64	2-1/2	914	1372	1372	150	310
76	3	1260	1580	1580	170	350
83	3-1/4	1330	1680	1680	190	390

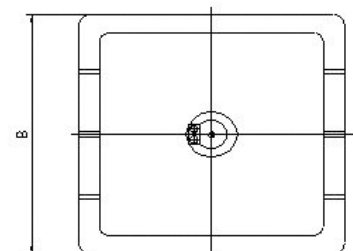
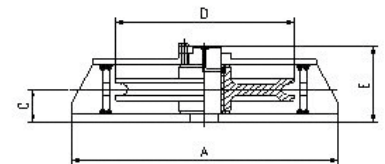

BRACKET - SMIT BRACKET

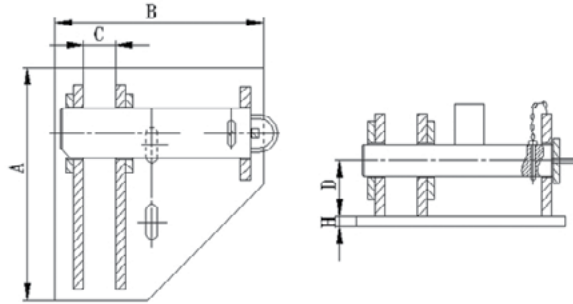

Nominal No.	Weight (kg)	Dimensions (mm)				
		A	B	C	D	H
54-56	160	500	450	75	160	25
62-64	198	625	600	100	180	35
76-78	311	800	720	110	228	35

STOPPER - CHAIN CABLE STOPPER

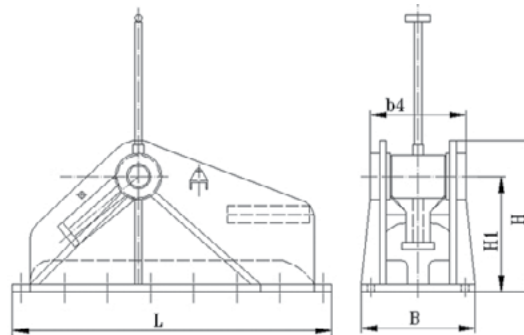

Nominal No.	Weight (kg)	Dimensions (mm)				
		L	B	H	H1	b4
54-56	488	1336	474	631	481	400
76-78	1421	1800	640	850	648	540

BOLLARD - CURVED TYPE A

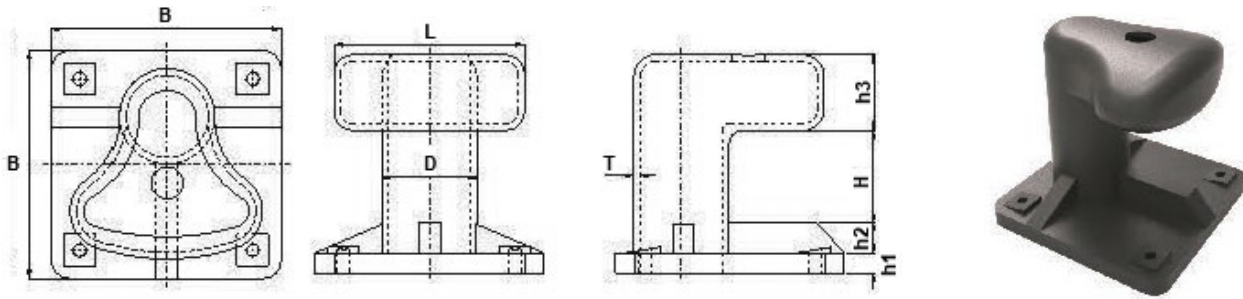

Model No.	Bolts Qty.	Dimensions (mm)							
		D	H	T	L	B	h1	h2	h3
6T	4	150	170	20	300	360	30	60	120
10T	4	200	210	20	400	460	40	70	150
15T	4	250	250	20	500	600	50	80	200
25T	4	300	200	21	600	720	65	95	240
35T	4	300	280	25	600	810	65	95	240
50T	4	350	330	29	700	945	70	100	280
75T	4	400	370	33	800	1180	90	120	320
100T	4	450	410	39	900	1365	95	125	360

BOLLARD - DOCK TYPE J

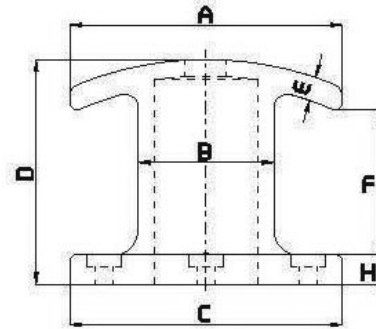

Model No.	Bolts Qty.	SWA (t)	Dimensions (mm)							
			A	B	C	D	E	F	G	H
J-01	4	10	180	120	240	190	25	140	180	25
J-02	4	16	216	150	290	220	25	160	220	35
J-03	4	20	280	200	380	260	25	200	280	35
J-04	4	16	290	150	290	220	25	160	220	35
J-05	6	50	400	230	480	380	40	244	340	60

BOLLARD - DOUBLE BITT LXY-B09

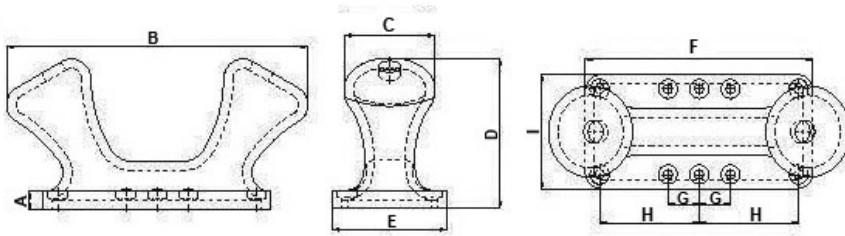

Model No.	Dimensions (mm)									Bolt Size	Bolt Length	Qty.
	A	B	C	D	E	F	G	H	I			
20T	38	678	204	204	267	533	70	222	191	M20	300	8
30T	46	781	235	389	302	604	81	258	221	M22	300	8
50T	56	942	285	469	356	711	98	311	267	M30	450	8
75T	62	1144	346	670	432	884	189	378	324	M36	450	10
100T	75	1346	407	670	508	1016	222	444	381	M42	600	10
125T	80	1548	468	771	508	1168	256	512	438	M42	600	10
150T	91	1683	509	838	635	1270	278	556	476	M48	750	10
200T	96	1886	570	936	702	1422	311	622	533	M56	915	10

BOLLARD - DOUBLE BITT LXY-B10

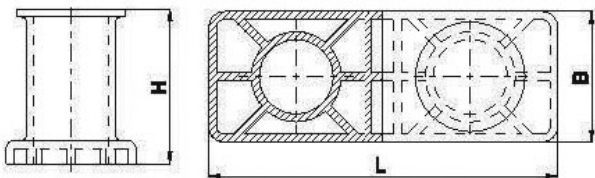
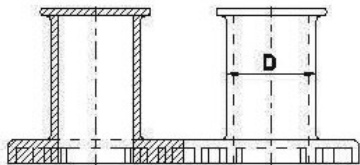

Model No.	Weight (kg)	Dimensions (mm)			
		D	L	B	H
100	19	114	445	165	196
125	29	140	540	195	246
160	45	168	670	225	316
200	80	219	860	290	378
250	141	273	1065	360	470
315	264	325	1300	430	597
355	369	351	1476	480	663
400	499	402	1630	550	749
450	680	450	1840	620	841
500	911	508	1040	690	926
560	1208	560	2240	750	1026
630	1601	610	2510	820	1152
710	2252	712	2840	960	1294
800	3071	813	3240	1100	1480

BOLLARD - DOUBLE BIT DECK MOUNT LXY-B011

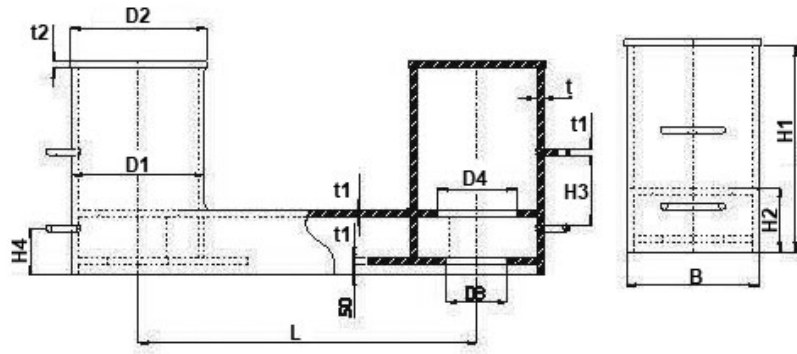

Model No.	Dimensions (mm)									SWL (t)	Weight (kg)
	D1	D2	D3	D4	H1	H2	B	L	E		
150	166.2	185	-	80	330	90	155	400	-	5T	29
200	226.3	240	-	130	395	115	205	600	-	6.7T	46
250A	257.4	290	-	160	505	135	250	630	-	14T	107
250B	257.4	290	-	160	505	135	250	630	-	11T	91
300A	328.5	340	150	185	600	150	290	600	300	31T	281
300B	328.5	340	150	185	600	150	290	600	300	16T	166
350A	355.8	380	170	200	685	175	340	890	350	43T	431
350B	355.8	380	170	200	685	175	340	890	350	22T	241
400A	406.4	430	190	230	730	185	380	1000	380	53T	570
400B	406.4	430	190	230	730	185	380	1000	380	27T	322
450A	457.2	480	210	265	770	195	425	1100	410	62T	712
450B	457.2	480	210	265	770	195	425	1100	410	30T	379
500A	508	530	235	295	830	230	480	1250	460	77T	880
500B	508	530	235	320	830	230	480	1250	460	33T	485
550A	558.8	680	255	330	900	270	520	1380	540	83T	1123
550B	558.8	680	255	350	900	270	520	1380	540	55T	787
600	609.4	830	280	365	950	300	560	1660	600	87T	1391

BOLLARD - DECK MOUNT LX-Y-B012

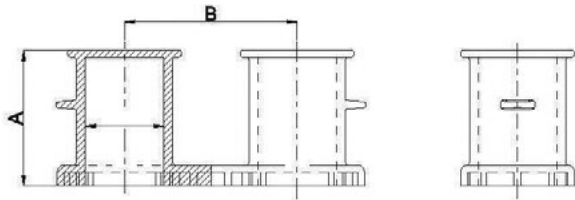
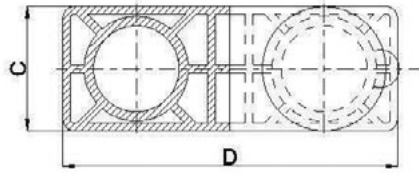

Model No.	Dimensions (mm)				Weight (kg)
	A	B	C	D	
19.8	196	250	165	445	100
29.4	248	315	195	640	125
44.7	316	400	225	670	160
79.5	378	500	290	860	200
139	470	630	360	1065	250
261	597	800	430	1300	315
362	663	890	480	1476	355
602	740	1000	550	1630	400
685	841	1130	620	1840	450
911	928	1250	690	2040	500
1208	1025	1380	750	2240	560
1601	1152	1670	820	2510	630
2252	1294	1750	900	2840	710
3071	1480	2000	1100	3240	800

BOLLARD - SINGLE BITT

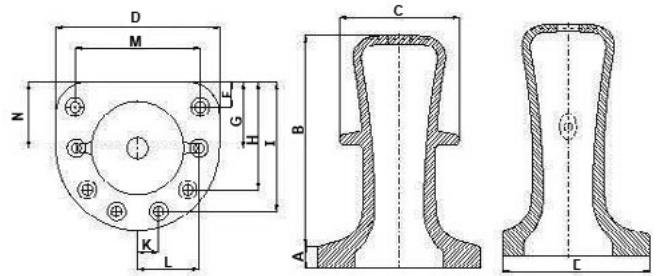

Model No.	Dimensions (mm)														Bolt Size	Bolt Length	Qty.
	A	B	C	D	E	F	G	H	I	J	K	L	M	N			
10T	44	390	224	325	284	46	-	-	205	83	-	-	234	122	M24	450	4
15T	44	429	246	358	313	50	-	-	225	91	-	-	257	184	M24	450	4
20T	54	454	263	358	322	54	-	201	281	0	124	-	275	149	M24	450	5
30T	60	540	307	419	377	63	-	236	328	0	140	-	321	189	M30	450	5
50T	70	696	391	533	480	80	-	256	394	96	200	-	409	213	M36	600	6
75T	82	829	475	648	583	97	-	311	476	117	249	-	497	259	M42	600	6
100T	89	925	559	762	688	114	330	522	607	0	195	291	584	305	M46	760	7
125T	92	1067	604	823	741	123	357	564	645	0	211	314	631	329	M48	760	7
150T	96	1153	659	899	809	135	390	616	704	0	231	343	689	360	M68	915	7
200T	111	1270	726	991	892	149	396	814	755	124	311	380	769	396	M68	915	8

BOLLARD - SINGLE-BITE TYPE JIS

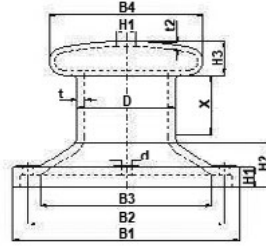

Model No.	Size (mm)												Kgs
	D	X	t	B4	H3	t2	H1	H2	B3	B1	B2	d	
15T	250	290	20	400	87	25	45	100	430	600	500	43	130
25T	300	290	20	460	106	15	50	130	510	725	600	55	220
35T	300	290	25	480	106	16	60	130	510	725	600	55	230
50T	350	330	27	550	122	16	70	160	600	810	700	66	350
70T	400	380	30	610	140	23	80	190	680	900	800	74	530
100T	450	410	35	720	157	25	90	270	680	1180	1000	74	893
150T	630	510	40	880	192	29	100	340	1010	1440	1220	91	1450
200T	750	550	43	1030	227	39	110	410	1240	1700	1440	101	2230

BOLLARD - TYPE STAG HORN

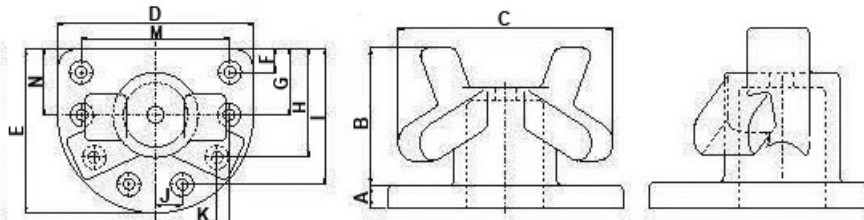

Model No.	Dimensions (mm)														Bolt Size	Bolt Length	Qty.
	A	B	C	D	E	F	G	H	I	J	K	L	M	N			
10T	41	291	348	381	330	44	-	-	243	103	-	-	291	140	M24	450	4
15T	45	320	394	419	363	49	-	-	287	114	-	-	320	154	M24	450	4
20T	49	349	430	442	391	49	-	234	335	0	159	-	349	160	M24	450	6
30T	66	392	483	497	429	51	-	263	377	0	179	-	393	180	M30	450	5
50T	69	419	616	530	457	55	-	281	402	0	191	-	419	192	M36	600	5
75T	71	469	627	645	556	67	-	287	459	120	250	-	509	233	M42	600	6
100T	81	559	717	737	636	76	292	484	559	0	195	291	532	267	M42	600	7
125T	90	616	788	810	690	84	321	532	615	0	215	320	640	293	M48	750	7
150T	99	671	880	884	762	91	351	541	671	0	235	349	698	320	M48	750	7
200T	102	699	896	921	794	95	333	543	679	119	299	365	727	333	M56	915	8

BOLLARD - T-HEAD

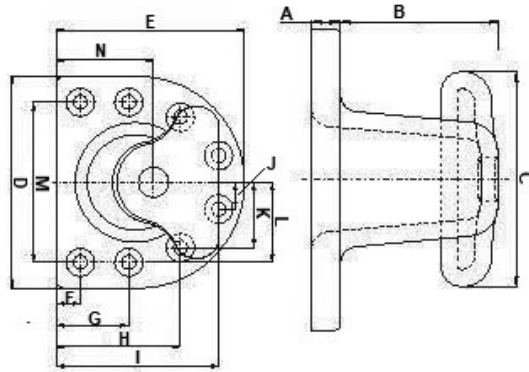

Model No.	Dimensions (mm)														Bolt Size	Bolt Length	Qty.
	A	B	C	D	E	F	G	H	I	J	K	L	M	N			
MT10	47	199	305	381	330	44	-	-	243	103	-	-	292	169	M24	460	4
MT15	52	219	335	419	363	49	-	-	307	114	-	-	321	208	M24	460	4
MT20	54	240	351	435	380	51	-	232	329	0	152	-	336	217	M24	460	5
MT30	57	250	366	457	396	53	-	242	343	0	159	-	351	225	M30	460	5
MT60	70	308	451	564	489	65	-	266	423	0	196	-	432	279	M36	600	5
MT75	80	354	518	648	561	76	-	298	463	105	241	-	497	321	M42	600	6
MT100	80	419	610	762	660	89	305	406	572	0	195	291	584	377	M42	600	7
MT125	87	458	671	838	726	98	335	546	629	0	215	320	643	415	M48	750	7
MT150	87	492	719	899	779	105	360	566	674	0	231	343	689	445	M48	750	7
MT200	97	521	762	952	826	111	349	559	684	119	299	365	730	472	M56	915	8



MOORING CONNECTOR - H-LINKS

H-Links - Forged and Plate Styles

Oceanside Equipment is the world leader in the design and manufacture of mooring H-links. With many high-profile projects Oceanside has worked closely with its client to complete and innovate connecting components for deep water moorings. Many of these projects span over several years from concept to installation. The experience we have acquired is used in the design and customization of the Links to improve the installation and in-service requirements of our clients. The deep-water industry has evolved over the years with new standards and class requirements. Many of these moorings have a service life of 20 years to 40 years. Oceanside has worked with clients and Class with engineering studies and

full size testing to confirm the inner workings of the design and features of our links. The traceability of our components begins at the ladle steel pour, followed and tested at many stages throughout production. Project specific ITP and MPS are prepared for full compliance to client and class requirements. The final load testing is done with our 3000 te purpose built test bed.

Project – Reference List



•Ocean Confidence	730 te
•MadDog	1,895 te
•Red Hawk	1,246 te
•ATP Rowan Midland	602 te
•Thunderhorse	1,386 te
•Independence Hub	1,527 te
•Tahiti	1,875 te
•BlindFaith	1,665 te
•Balmoral FPV	
•Triton FPSO	
•Kikeh	1,441 te
•Mirage	1,501 te
•ThunderHawk	1,964 te
•West Berani at Tombua Landana	
•Anasuria FPSO	
•Exxon Balder	
•Oxy Petroleum FPSO	
•Technip Lucius	2,131 te
•Chervon Jack St Malo	2,558 te
•GulfStar 1	1,501 te
•Heidelberg	2,131 te
•Asta Hansteen	2,437 te
•Appomattox	2,632 te

602 to 2632te MBL

CONTAINER LIFTING - SEA-STAB

Introducing Sea-Stab

A rapidly deployed, preset, re-usable, high-load connector, container latching and lifting system. Innovative, 'hands free' cargo lifting connection in a dynamic environment.

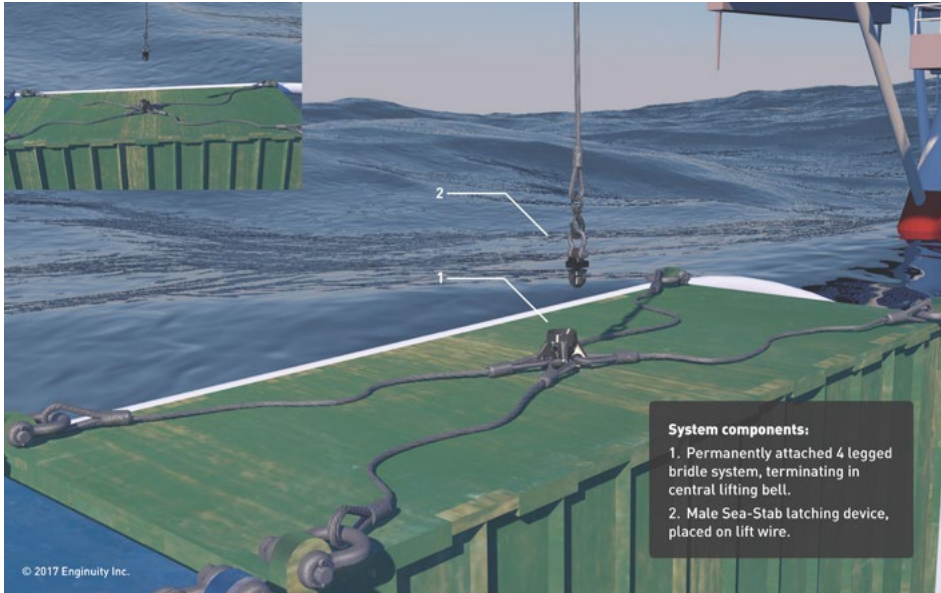

System components:
 1. Permanently attached 4 legged
 bridle system, terminating in
 central lifting bell.
 2. Male Sea-Stab latching device,
 placed on lift wire.

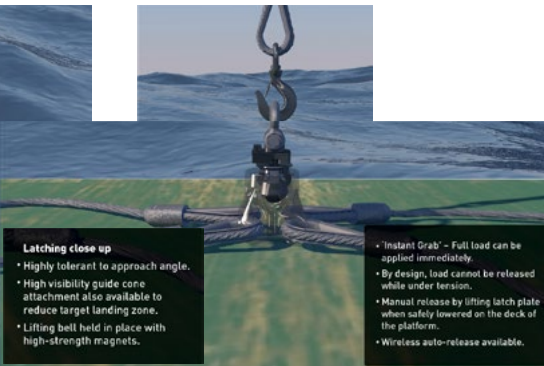
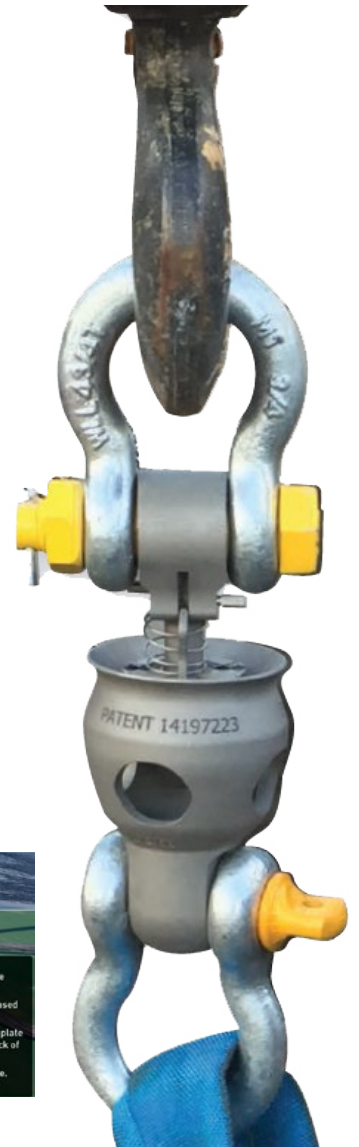

Latching close up
 • Highly tolerant to approach angle.
 • High visibility guide cone attachment also available to reduce target landing zone.
 • Lifting bell held in place with high-strength magnets.

• 'Instant Grab' - Full load can be applied immediately.
 • By design, load cannot be released while under tension.
 • Manual release by lifting latch plate when safely lowered on the deck of the platform.
 • Wireless auto-release available.

Connects in Seconds - Stays for Life
www.sea-stab.com

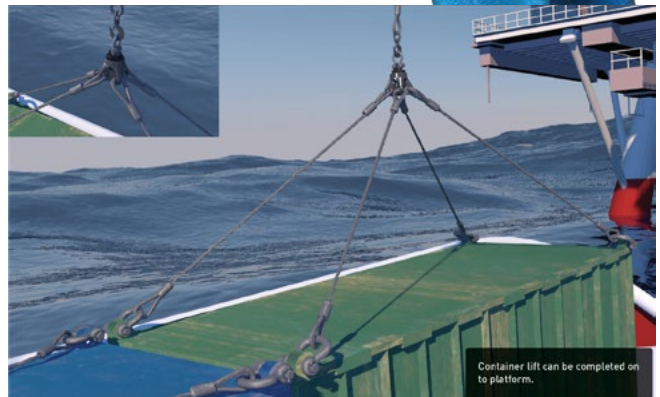

Container lift can be completed on to platform.

PERMANENT MOORING CONNECTIONS MADE SIMPLE

SEAoStab™



Connects in Seconds.
Stays for Life.



Female and male components with optional padeye



A new subsea mooring connector that's lighter, simpler, stronger and more cost effective than traditional 'ball and taper' technology

Whether you're installing a pre-lay for a MODU, a new spread for an offloading system or replacing a line on an FPSO, SEA-Stab™ from Engenuity offers simple, cost-effective and rapid connection. Designed to be stronger than any equivalent sized chain, with a fully scalable design allowing for working loads up to 30,000kN.

SEA-Stab™ outperforms traditional permanent or re-connectable technologies.

- Zero deformation at full chain MBL, ensuring connector remains 'Truly' reconnectable
- Cost effective design reduces capital cost
- Self-centers during deployment with wide approach angles, reducing installation costs
- Fully inspectable during installation and throughout life, ensuring 'fitness for purpose'
- Only 5 Moving parts with no dissimilar materials reducing corrosion risk
- Configurable coupling reduces need for additional components during hook-up

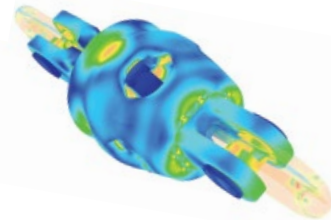

Finite Element Analysis showing connector at chain break load



Design Approved by:



Patent No. US 9,488,203 B2 • © Copyright 2017 Engenuity Inc. • www.sea-stab.com • +1.902.431.7931

SLINGS

Wire Rope Slings - Bright.....	217 - 218
Wire Rope Slings - Galvanized.....	219 - 221
Wire Rope Sling Chart.....	222 - 223
Web Slings.....	224 - 225
Polyester Webbing.....	226
Round Slings.....	227 - 229
Twin Path.....	230



SLING - WIRE ROPE, BRIGHT, WITH A1 LIGHT LUBE

1/2", 5/8", 3/4", 7/8"

Diameter of Wire Rope vs. Standard length for Pricing
(5:1 by design API spec. 9a table 3.7)

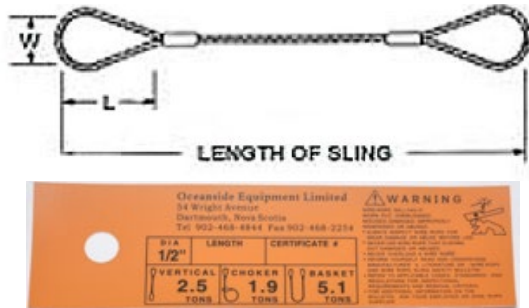

Length (ft)	1/2"		5/8"		3/4"		7/8"	
	Price / ea.	Part #	Price / ea.	Part #	Price / ea.	Part #	Price / ea.	Part #
3	23.91	SE-B-1/2X3	43.19	SE-B-5/8X3				
4	26.52	SE-B-1/2X4	47.08	SE-B-5/8X4	69.24	SE-B-3/4X4	113.26	SE-B-7/8X4
5	29.12	SE-B-1/2X5	50.97	SE-B-5/8X5	74.63	SE-B-3/4X5	120.64	SE-B-7/8X5
6	31.71	SE-B-1/2X6	54.85	SE-B-5/8X6	80.03	SE-B-3/4X6	128.03	SE-B-7/8X6
7	34.32	SE-B-1/2X7	58.75	SE-B-5/8X7	85.44	SE-B-3/4X7	135.42	SE-B-7/8X7
8	36.91	SE-B-1/2X8	62.63	SE-B-5/8X8	90.83	SE-B-3/4X8	142.80	SE-B-7/8X8
9	39.51	SE-B-1/2X9	66.53	SE-B-5/8X9	96.23	SE-B-3/4X9	150.19	SE-B-7/8X9
10	42.11	SE-B-1/2X10	70.40	SE-B-5/8X10	101.63	SE-B-3/4X10	157.57	SE-B-7/8X10
11	44.70	SE-B-1/2X11	74.29	SE-B-5/8X11	107.03	SE-B-3/4X11	164.96	SE-B-7/8X11
12	47.31	SE-B-1/2X12	78.19	SE-B-5/8X12	112.43	SE-B-3/4X12	172.36	SE-B-7/8X12
15	55.10	SE-B-1/2X15	89.83	SE-B-5/8X15	128.62	SE-B-3/4X15	194.52	SE-B-7/8X15
20	68.09	SE-B-1/2X20	109.28	SE-B-5/8X20	155.61	SE-B-3/4X20	231.43	SE-B-7/8X20
Std. eye size (in)	4 x 8		5 x 10		6 x 12		7 x 14	
WLL (T)	2.5		3.9		5.6		7.6	
Wt / ft (lb)	0.46		0.72		1.04		1.42	

*All wire rope slings made with EIPS, IWRC Bright Wire rope with A1 light lube with steel ferrule and Flemish roll splice complete with tag showing size, length, WLL and manufacture. Rated in Imperial Ton(s) (2000 lb).

SLING - WIRE ROPE, BRIGHT, WITH A1 LIGHT LUBE

1", 1-1/8", 1-1/4"

Diameter of Wire Rope vs. Standard length for Pricing
(5:1 by design API spec. 9a table 3.7)



Length (ft)	1"		1-1/8"		1-1/4"	
	Price / ea.	Part #	Price / ea.	Part #	Price / ea.	Part #
3	-	-	-	-	-	-
4	-	-	-	-	-	-
5	164.74	SE-B-1X5	222.59	SE-B-1-1/8X5	-	-
6	174.40	SE-B-1X6	235.22	SE-B-1-1/8X6	306.96	SE-B-1-1/4X6
7	184.05	SE-B-1X7	247.84	SE-B-1-1/8X7	322.38	SE-B-1-1/4X7
8	193.71	SE-B-1X8	260.47	SE-B-1-1/8X8	337.78	SE-B-1-1/4X8
9	203.38	SE-B-1X9	273.10	SE-B-1-1/8X9	353.20	SE-B-1-1/4X9
10	213.04	SE-B-1X10	285.72	SE-B-1-1/8X10	368.61	SE-B-1-1/4X10
11	222.70	SE-B-1X11	298.35	SE-B-1-1/8X11	384.02	SE-B-1-1/4X11
12	232.37	SE-B-1X12	310.97	SE-B-1-1/8X12	399.43	SE-B-1-1/4X12
15	261.35	SE-B-1X15	348.85	SE-B-1-1/8X15	445.65	SE-B-1-1/4X15
20	309.65	SE-B-1X20	411.98	SE-B-1-1/8X20	522.70	SE-B-1-1/4X20
Std. eye size (in)	8 x 16		9 x 18		10 x 20	
WLL (T)	9.8		12		15	
Wt / ft (lb)	1.85		2.34		2.89	

*All wire rope slings made with EIPS, IWRC Bright Wire rope with A1 light lube with steel ferrule and Flemish roll splice complete with tag showing size, length, WLL and manufacture. Rated in Imperial Ton(s) (2000 lb).

SLING - WIRE ROPE, GALVANIZED 1/4", 3/8", 1/2", 5/8"

Diameter of Wire Rope vs. Standard length for Pricing
(5:1 by design API spec. 9a table 3.7)

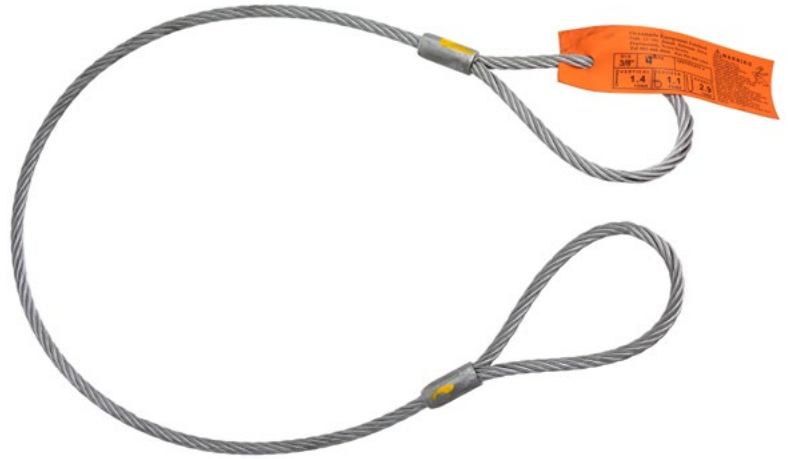

Length (ft)	1/4"		3/8"		1/2"		5/8"	
	Price / ea.	Part #	Price / ea.	Part #	Price / ea.	Part #	Price / ea.	Part #
2	9.73	SE-G-1/4X2	12.96	SE-G-3/8X2	-	-	-	-
3	10.89	SE-G-1/4X3	14.61	SE-G-3/8X3	26.70	SE-G-1/2X3	48.42	SE-G-5/8X3
4	12.05	SE-G-1/4X4	16.25	SE-G-3/8X4	29.85	SE-G-1/2X4	53.16	SE-G-5/8X4
5	13.22	SE-G-1/4X5	17.91	SE-G-3/8X5	33.00	SE-G-1/2X5	57.92	SE-G-5/8X5
6	14.39	SE-G-1/4X6	19.54	SE-G-3/8X6	36.15	SE-G-1/2X6	62.67	SE-G-5/8X6
7	15.55	SE-G-1/4X7	21.20	SE-G-3/8X7	39.32	SE-G-1/2X7	67.44	SE-G-5/8X7
8	16.72	SE-G-1/4X8	22.83	SE-G-3/8X8	42.47	SE-G-1/2X8	72.19	SE-G-5/8X8
9	17.88	SE-G-1/4X9	24.48	SE-G-3/8X9	45.62	SE-G-1/2X9	76.95	SE-G-5/8X9
10	19.04	SE-G-1/4X10	26.13	SE-G-3/8X10	48.77	SE-G-1/2X10	81.71	SE-G-5/8X10
11	20.22	SE-G-1/4X11	27.78	SE-G-3/8X11	51.93	SE-G-1/2X11	86.47	SE-G-5/8X11
12	21.38	SE-G-1/4X12	29.42	SE-G-3/8X12	55.10	SE-G-1/2X12	91.22	SE-G-5/8X12
15	24.87	SE-G-1/4X15	34.35	SE-G-3/8X15	64.56	SE-G-1/2X15	105.49	SE-G-5/8X15
20	30.69	SE-G-1/4X20	42.59	SE-G-3/8X20	80.33	SE-G-1/2X20	129.27	SE-G-5/8X20
Std. eye size (in)	2 x 4		3 x 6		4 x 8		5 x 10	
WLL (T)	0.65		1.4		2.5		3.9	
Wt. / ft (lb)	0.116		0.26		0.46		0.72	

*All wire rope slings made with EIPS, IWRC Galvanized Wire rope with A1 steel ferrule and Flemish roll splice complete with tag showing size, length, WLL and manufacture. Rated in Imperial Ton(s) (2000 lb)

SLING - WIRE ROPE, GALVANIZED

3/4", 7/8", 1", 1-1/8"

Diameter of Wire Rope vs. Standard length for Pricing
(5:1 by design API spec. 9a table 3.7)

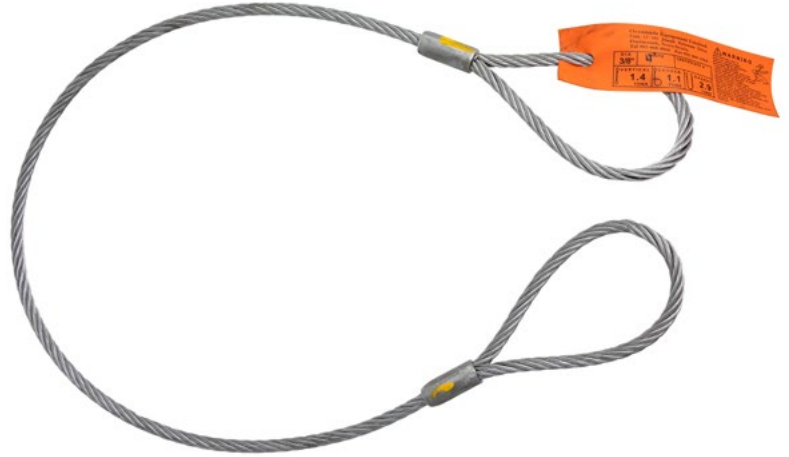

Length (ft)	3/4"		7/8"		1"		1-1/8"	
	Price / ea.	Part #	Price / ea.	Part #	Price / ea.	Part #	Price / ea.	Part #
4	77.88	SE-G-3/4X4	126.98	SE-G-7/8X4	-	-	-	-
5	84.50	SE-G-3/4X5	136.09	SE-G-7/8X5	185.76	SE-G-1X5	251.48	SE-G-1-1/8X5
6	91.14	SE-G-3/4X6	145.20	SE-G-7/8X6	197.63	SE-G-1X6	266.99	SE-G-1-1/8X6
7	97.76	SE-G-3/4X7	154.30	SE-G-7/8X7	209.51	SE-G-1X7	282.50	SE-G-1-1/8X7
8	104.40	SE-G-3/4X8	163.41	SE-G-7/8X8	221.38	SE-G-1X8	298.03	SE-G-1-1/8X8
9	111.03	SE-G-3/4X9	172.50	SE-G-7/8X9	233.26	SE-G-1X9	313.55	SE-G-1-1/8X9
10	117.66	SE-G-3/4X10	181.60	SE-G-7/8X10	245.14	SE-G-1X10	329.05	SE-G-1-1/8X10
11	124.31	SE-G-3/4X11	190.71	SE-G-7/8X11	257.03	SE-G-1X11	344.57	SE-G-1-1/8X11
12	130.92	SE-G-3/4X12	199.81	SE-G-7/8X12	268.88	SE-G-1X12	360.12	SE-G-1-1/8X12
15	150.81	SE-G-3/4X15	227.12	SE-G-7/8X15	304.50	SE-G-1X15	406.63	SE-G-1-1/8X15
20	183.96	SE-G-3/4X20	272.63	SE-G-7/8X20	363.87	SE-G-1X20	484.20	SE-G-1-1/8X20
Std. eye size (in)	6 x 12		7 x 14		8 x 16		9 x 18	
WLL (T)	5.6		7.6		9.8		12	
Wt. / ft (lb)	1.04		1.42		1.85		2.34	

*All wire rope slings made with EIPS, IWRC Galvanized Wire rope with A1 steel ferrule and Flemish roll splice complete with tag showing size, length, WLL and manufacture. Rated in Imperial Ton(s) (2000 lb)

SLING - WIRE ROPE, GALVANIZED 1-1/4", 1-1/2", 1-3/4", 2", 2-1/4", 2-1/2"

Diameter of Wire Rope vs. Standard length for Pricing
(5:1 by design API spec. 9a table 3.7)

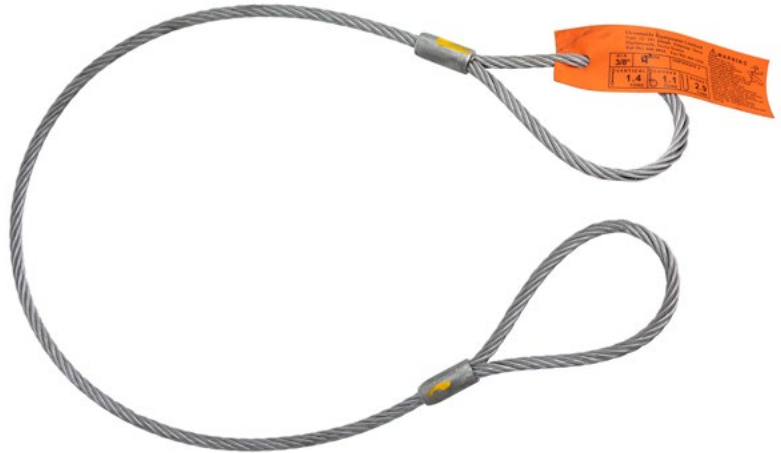















Length (ft)	1-1/4"		1-1/2"		1-3/4"	2"	2-1/4"	2-1/2"
	Price / ea.	Part #	Price / ea.	Part #				
6	347.56	SE-G-1-1/4X6	522.59	SE-G-1-1/2X6				
7	366.48	SE-G-1-1/4X7	549.16	SE-G-1-1/2X7		-	-	-
8	385.43	SE-G-1-1/4X8	575.79	SE-G-1-1/2X8		-	-	-
9	404.37	SE-G-1-1/4X9	602.37	SE-G-1-1/2X9			-	-
10	423.31	SE-G-1-1/4X10	629.00	SE-G-1-1/2X10	Pricing on Request	Pricing on Request	Pricing on Request	Pricing on Request
11	442.24	SE-G-1-1/4X11	655.58	SE-G-1-1/2X11				
12	461.19	SE-G-1-1/4X12	682.20	SE-G-1-1/2X12				
15	518.01	SE-G-1-1/4X15	761.99	SE-G-1-1/2X15				
20	612.76	SE-G-1-1/4X20	895.01	SE-G-1-1/2X20				
Std. eye size (in)		10 x 20		12 x 24	14 x 28	16 x 32	18 x 36	20 x 40
WLL (T)		15		21	28	37	44	54
Wt. / ft (lb)		2.89		4.16	5.67	7.39	9.36	11.6

*All wire rope slings made with EIPS, IWRC Galvanized Wire rope with A1 steel ferrule and Flemish roll splice complete with tag showing size, length, WLL and manufacture. Rated in Imperial Ton(s) (2000 lb)

WIRE ROPE SLING CHARTS

SLINGS

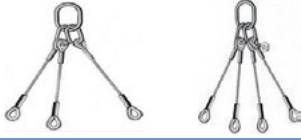
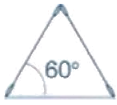
Wire Rope Dia. (in)	Single Leg			2 Slings or Basket Hitch			2 Sling Basket Hitch			2 Sling Choker Hitch		
	Vertical	Choker	V.Basket	Horizontal			Horizontal			Horizontal		
												
	Load	Load	Load	60°	45°	30°	60°	45°	30°	60°	45°	30°
1/4"	0.65	0.48	1.3	1.1	0.91	0.65	2.3	1.8	1.3	0.82	0.7	0.48
5/16"	1.0	0.74	2.0	1.7	1.4	1.0	3.5	2.8	2.0	1.3	1.1	0.74
3/8"	1.4	1.1	2.8	2.5	2.0	1.4	4.8	4.0	2.8	1.8	1.5	1.1
7/16"	1.9	1.4	3.8	3.4	2.7	1.9	6.6	5.4	3.8	2.5	2.0	1.4
1/2"	2.5	1.9	5.0	4.4	3.6	2.5	8.7	7.1	5.0	3.2	2.7	1.9
9/16"	3.2	2.4	6.4	5.5	4.5	3.2	11	9.0	6.4	4.1	3.4	2.4
5/8"	3.9	2.9	7.8	6.8	5.5	3.9	14	11	7.8	5.0	4.1	2.9
3/4"	5.6	4.1	11	9.7	7.9	5.6	19	16	11	7.1	5.9	4.1
7/8"	7.6	5.6	15	13	11	7.6	26	22	15	9.7	8.1	5.6
1"	9.8	7.2	20	17	14	9.8	34	28	20	13	10	7.2
1-1/8"	12	9.7	24	21	17	12	42	33	24	16	13	9.1
1-1/4"	15	11	30	26	21	15	52	42	30	19	16	11
1-3/8"	18	13	36	31	25	18	62	51	36	23	19	13
1-1/2"	21	16	42	37	30	21	72	59	42	28	22	16
1-3/4"	28	21	56	49	40	28	97	79	56	37	29	21
2"	37	28	74	63	52	37	128	104	74	48	39	28

Wire Rope Dia. (in)	3 and 4 Leg Wire Rope Bridles		
			
	Horizontal		
			
1/4"	1.7	1.4	0.97
5/16"	2.6	2.1	1.5
3/8"	3.7	3.0	2.2
7/16"	5.0	4.1	2.9
1/2"	6.6	5.4	3.8
9/16"	8.3	6.8	4.8
5/8"	10	8.3	5.9
3/4"	15	12	8.4
7/8"	20	16	11
1"	26	21	15
1-1/8"	31	26	18
1-1/4"	38	31	22
1-3/8"	46	38	27
1-1/2"	55	45	32
1-3/4"	74	60	42
2"	95	78	55

- Rated load for 6 x19 or 6 x 36 classification.
- Extra Improved Plow Steel (EIPS).
- Independent Wire Rope Core (IWRC).
- Wire Rope - Design Factor of 5:1.
- Loads rated in US/Short Tons (2,000 lb).
- Basket Hitch based on D/d Ratio of 25.
- Flemish Ferrule Eye Splice.
- Values rounded for convenience.

SLING - WEB, POLYESTER

Sling Considerations:

Polyester web slings offer several features which promote their popularity among riggers. They are often used when highly polished, fragile or delicate loads must be lifted. The softness of the web will lessen marring, or scratch loads, while its flexibility assures a firm grip around the item being lifted. The light weight of the material, combined with flexibility allows the slings to be quickly & safely handled by riggers.

- Web slings are lightweight, flexible and easy to handle and rig.
- Web slings are less damaging on contacting load surfaces than metal slings.
- Web slings may provide a wider surface for load distribution.

Identification / Marking:

1. Three basic WLL hitches: (Vertical, Choker, Vertical Basket).
2. Length: Bearing point to bearing point.
3. Type of fiber: (Polyester)
4. Name or trademark of manufacturer.
5. Manufacturer's code or stock number.

Additional Identification:

5. Includes warning labels for use and inspection with each new web sling.
6. Blue fiber I.D. marker.

Identification Included (but not Required):

7. Unique Serial No

Coatings & Protection:

1. Abrasion resistance.
2. Sealing to prevent penetration of foreign particles and matter.
3. Increased coefficient of friction.
4. Ultraviolet light resistance.
5. Cordura cover
6. Black edge treated
7. Clear PVC covering identification.



INSPECTION DATE	YEAR	J	F	M	A	M	J	J	A	S	O	N	D

Manufacturing Information:

- A synthetic web sling is fabricated by sewing woven synthetic webbing of nylon or polyester type yarns into basic sling types with or without fittings.
- Type 3 - Web slings are made with a flat loop eye on each end with the loop eye opening in the same plane as the sling body. This type of sling is sometimes called a flat eye sling, eye and eye sling or double eye sling.
- Type 4 - Web sling made with both loop eyes formed as in Type 3, except that the loop eyes are turned at a right angle to the plane of the sling body. This type of sling is commonly referred to as a twisted eye sling. The eye is formed by turning the fabric 180° before sewing to form an eye 90° to the sling body. This allows for easier chocking.
- Web Slings are manufactured in compliance with WSTDA-WS-1 and exceed ASME B30.9 requirements.
- Webbing used is in compliance with WSTDA-WB-1

Reference: WSTDA-WB-1:2010

Design/Safety Factor: 5:1

- The sling design factor is based on destructive, laboratory controlled testing conditions, which will not be exactly duplicated during actual load conditions. Never load any sling in excess of its rated WLL.

Recommended Operating Practice:

- See: WSTDA-WS-2, available on request.
- Web Slings that are used outdoors regularly should generally be permanently removed from service within a period of 2 to 4 years.



SLING - WEB, POLYESTER

Length (ft)	1", 1-ply type 3		1", 2-ply type 4		2", 2-ply type 4	
	Price / ea.	Part #	Price / ea.	Part #	Price / ea.	Part #
2	4.79	8-901x2	5.22	8-901X2-2P	7.61	8-902x2
4	7.56	8-901x4	7.70	8-901X4-2P	11.82	8-902x4
6	8.80	8-901x6	10.10	8-901X6-2P	16.12	8-902x6
8	10.18	8-901x8	12.58	8-901X8-2P	20.34	8-902x8
10	11.81	8-901x10	15.07	8-901X10-2P	24.56	8-902x10
12	13.30	8-901x12	17.42	8-901X12-2P	28.80	8-902x12
15					35.25	8-902x15
16					37.32	8-902x16
18					41.57	8-902x18
20					45.85	8-902x20
Eye size	10"		10"		10"	
Vertical	1600 lb		3100 lb		6200 lb	
Basket	3200 lb		6200 lb		12 400 lb	
Choker	1280 lb		2480 lb		4960 lb	

Length (ft)	3", 2-ply type 4		4", 2-ply type 4		6", 2-ply type 4	
	Price / ea.	Part #	Price / ea.	Part #	Price / ea.	Part #
2	10.92	8-903x2				
4	17.55	8-903x4	22.97	8-904x4		
6	24.17	8-903x6	31.82	8-904x6		
8	30.81	8-903x8	40.76	8-904x8		
10	37.40	8-903x10	49.65	8-904x10	104.77	8-906x10
12	44.05	8-903x12	58.54	8-904x12		
15	54.00	8-903x15	71.80	8-904x15	152.25	8-906x15
16	57.30	8-903x16	76.22	8-904x16		
18	63.97	8-903x18	85.12	8-904x18		
20	70.67	8-903x20	94.03	8-904x20	199.57	8-906x20
25	87.18	8-903x25	116.15	8-904x25	247.05	8-906x25
30			138.37	8-904x30	294.52	8-906x30
Eye size	12"		12"		18"	
Vertical	8800 lb		11 000 lb		16 500 lb	
Basket	17 600 lb		22 000 lb		33 000 lb	
Choker	7040 lb		8800 lb		13 200 lb	



SLING - WEBBING MATERIAL, POLYESTER



- 9800 lb Polyester Webbing.
- Yellow with black edge & blue stripe in the middle.

Size (in)	Pallet Packaging (44"x44"x40") Qty (ft)	Price / ft.	Part Number
1	26 250	0.35	190-1"POLYESTERWEB
2	13 125	0.72	190-2"POLYESTERWEB
3	9840	1.12	190-3"POLYESTERWEB
4	7710	1.50	190-4"POLYESTERWEB
6	5515	2.52	190-6"POLYESTERWEB
8	3545	3.47	190-8"POLYESTERWEB
10	2955	4.50	190-10"POLYESTERWEB
12	2625	5.05	190-12"POLYESTERWEB

Size (in)	Roll Packaging Qty (ft)	Price / ft.	Part Number
1	328.08	0.35	190-1"X328'POLYESTERWEB
2	328.08	0.72	190-2"X328'POLYESTERWEB
3	328.08	1.12	190-3"X328'POLYESTERWEB
4	328.08	1.50	190-4"X328'POLYESTERWEB
6	328.08	2.52	190-6"X328'POLYESTERWEB
8	328.08	3.47	190-8"X328'POLYESTERWEB
10	328.08	4.50	190-10"X328'POLYESTERWEB
12	328.08	5.05	190-12"X328'POLYESTERWEB

SLING - ROUND, POLYESTER



Polyester Round Slings Working Load Limits

Code	Color	Vertical WLL in (T)						Approx. Dia (in)	Approx. Wt./ft (lb)
			Vertical	Choker	90° Basket (lb)	60° Basket	45° Basket		
OC-30	Purple	1.5	3000	2400	6000	5100	4200	0.75	0.25
OC-60	Green	3	6000	4800	12 000	10 300	8400	0.90	0.40
OC-90	Yellow	4.5	9000	7200	18 000	15 500	12 600	1.00	0.50
OC-140	Red	7	14 000	11 200	28 000	24 100	19 600	1.30	0.85
OC-230	Blue	11.5	23 000	18 400	46 000	39 500	32 200	1.65	1.25
OC-320	Grey	16	32 000	25 600	64 000	55 000	44 800	2.15	1.75
OC-400	Orange	20	40 000	32 000	80 000	68 800	56 000	2.45	2.25
OC-540	Brown	27	54 000	43 200	108 000	92 900	75 600	3.00	2.75
OC-680	Olive Green	34	68 000	54 400	136 000	117 000	95 200	3.25	3.60
OC-900	Black	45	90 000	72 000	180 000	155 000	126 000	3.75	4.10
OC-1000	Black	50	100 000	80 000	200 000	173 000	140 000	4.25	4.75

SLING - ROUND, POLYESTER

Sling Considerations:

Polyester round slings offer several notable characteristics including the following:

- Lightweight, flexible, and easy to handle and rig.
- Polyester roundsling elongation at rated capacity is approximately 3%, which is less than comparable nylon and polyester webbing slings.
- Wear points can be easily rotated to extend sling life.
- Polyester roundslings are easy to inspect.
- Polyester roundslings are less damaging on contacting load surfaces than metal type slings
- The exterior cover, aid in protecting the load bearing core yarn.

Identification / Marking:

1. Three basic WLL hitches: (Vertical, Choker, Vertical Basket).
2. Length: Bearing point to bearing point.
3. Core type: Polyester fiber.
4. Name or trademark of manufacturer.
5. Manufacturer's code or stock number.

Additional Identification:

6. Color coded, corresponding with WLL.
7. Includes warning labels for use and inspection with each new web sling

Identification Included (but not Required):

8. Unique Serial No.



INSPECTION DATE	YEAR	J	F	M	A	M	J	J	A	S	O	N	D	



Most slings are bagged individually.

Coatings & Protection:

1. Abrasion resistance.
2. Sealing to prevent penetration of foreign particles and matter.
3. Increased coefficient of friction.
4. Ultraviolet light resistance.
5. Heavy duty polyester cover
6. Clear PVC covering identification.

Manufacturing Information:

- The polyester core(s) is formed from one or more ends of continuous filament yarn, wound together in a plurality of turns. This yarn is continuous filament. The core(s) is uniformly wound to ensure even distribution of the load.
- The cover(s) is commonly the same fiber (polyester) type as the load bearing core(s) (polyester).
- Round Slings are manufactured in compliance with WSTDA-RS-1 and exceed ASME B30.9 requirements.

Design/Safety Factor: 5:1

The sling design factor is based on destructive, laboratory controlled testing conditions, which will not be exactly duplicated during actual load conditions. Never load any sling in excess of its rated WLL. Rated in Imperial Ton(s) (2000 lb).

Recommended Operating Practice:

See: WSTDA-RS-1, Ch 4.0, available on request. Reference: WSTDA-RS-1:2010.

Note:

For "proper" proof loading, you need to "Milk" the jacket cover to the seam to prevent the jacket/cover from ripping.

SLING - ROUND, POLYESTER

Length (ft)	OC-30		OC-60		OC-90		OC-140		OC-230		OC-320	
	Price / ea.	Part #	Price / ea.	Part #	Price / ea.	Part #	Price / ea.	Part #	Price / ea.	Part #	Price / ea.	Part #
3	6.78	6-OC30X3										
4	8.36	6-OC30X4	12.97	6-OC60X4	17.85	6-OC90X4	28.52	6-OC140X4				
6	12.28	6-OC30X6	18.15	6-OC60X6	25.72	6-OC90X6	41.80	6-OC140X6				
8	14.69	6-OC30X8	23.58	6-OC60X8	33.65	6-OC90X8	55.05	6-OC140X8	86.72	6-OC230X8	113.22	6-OC320X8
10	17.85	6-OC30X10	29.00	6-OC60X10	41.57	6-OC90X10	68.30	6-OC140X10	107.90	6-OC230X10	141.00	6-OC320X10
12	21.02	6-OC30X12	34.35	6-OC60X12	49.50	6-OC90X12	81.55	6-OC140X12	129.07	6-OC230X12	168.90	6-OC320X12
14			39.77	6-OC60X14	57.40	6-OC90X14	94.87	6-OC140X14	150.30	6-OC230X14	196.72	6-OC320X14
16	27.35	6-OC30X16	45.13	6-OC60X16	65.32	6-OC90X16	108.12	6-OC140X16	171.47	6-OC230X16	224.40	6-OC320X16
20	33.68	6-OC30X20	55.90	6-OC60X20	81.12	6-OC90X20	134.62	6-OC140X20	213.82	6-OC230X20	280.10	6-OC320X20
25							167.80	6-OC140X25	259.25	6-OC230X25	349.67	6-OC320X25
30							200.90	6-OC140X30	319.65	6-OC230X30	419.20	6-OC320X30

SLINGS

Length (ft)	OC-400		OC-540		OC-680		OC-900		OC-1000	
	Price / ea.	Part #	Price / ea.	Part #	Price / ea.	Part #	Price / ea.	Part #	Price / ea.	Part #
10	172.75	6-OC400X10	297.27	6-OC540X10	342.20	6-OC680X10	459.85	6-OC900X10		
12	206.90	6-OC400X12	356.27	6-OC540X12	410.17	6-OC680X12	551.37	6-OC900X12		
16	275.17	6-OC400X16	474.37	6-OC540X16	546.25	6-OC680X16	734.57	6-OC900X16		
20	343.52	6-OC400X20	592.50	6-OC540X20	682.32	6-OC680X20	917.72	6-OC900X20	1,055.37	6-OC1000X20
25	428.77	6-OC400X25	740.12	6-OC540X25	852.50	6-OC680X25	1,146.62	6-OC900X25	1,318.62	6-OC1000X25
30	514.17	6-OC400X30	887.75	6-OC540X30	1,022.55	6-OC680X30	1,375.65	6-OC900X30		
40	684.92	6-OC400X40	1,183.05	6-OC540X40	1,362.72	6-OC680X40	1,833.35	6-OC900X40		

TWIN-PATH® EXTRA COVERMAX® WITH CHECK-FAST® SLING WITH K-SPEC® CORE YARN

- The lightest and strongest sling on the market today, and the only repairable synthetic sling made
- Check-Fast® external warning indicator (EWI) provides a pass/ fail indication of the internal load bearing core yarns
- Heavy duty bulked nylon, 2 ply, 2 path, outer cover with superior abrasion resistance
- Overload tell-tails and a fiber optic internal inspection system
- Red inner cover provides an early warning safety alert
- 10% the weight of a wire rope sling of comparable length and capacity
- 1% stretch at rated capacity
- Proof tested to 2X rated capacity
- Design factor 5 to 1



Part Number Model(add length to end)	Rated Capacities in Lbs.					Approx. Weight per foot (bearing to bearing)	Nominal Body Width
	Vertical	Choker	90° Basket	60° Basket	45° Basket		
TPXCF 1000	10,000	8,000	20,000	17,320	14,140	.40	1.5 - 3"
TPXCF 1500	15,000	12,000	30,000	25,980	21,210	.45	1.5 - 3"
TPXCF 2000	20,000	16,000	40,000	34,640	28,280	.51	1.5 - 3"
TPXCF 2500	25,000	20,000	50,000	43,300	35,350	.57	2.0 - 4"
TPXCF 3000	30,000	24,000	60,000	51,960	42,420	.71	2.0 - 4"
TPXCF 4000	40,000	32,000	80,000	69,280	56,560	.83	2.0 - 4"
TPXCF 5000	50,000	40,000	100,000	86,600	70,700	1.14	2.5 - 5"
TPXCF 6000	60,000	48,000	120,000	103,920	84,840	1.27	2.5 - 5"
TPXCF 7000	70,000	56,000	140,000	121,240	98,980	1.39	2.5 - 5"
TPXCF 8500	85,000	68,000	170,000	147,220	120,190	1.65	3.0 - 6"
TPXCF 10000	100,000	80,000	200,000	173,200	141,400	1.84	3.0 - 6"
TPXCF 12500	125,000	100,000	250,000	216,500	176,750	2.35	4.0 - 8"
TPXCF 15000	150,000	120,000	300,000	259,800	212,100	2.66	4.0 - 8"
TPXCF 17500	175,000	140,000	350,000	303,100	247,450	3.14	4.0 - 8"
TPXCF 20000	200,000	160,000	400,000	346,400	282,800	3.45	5.0 - 10"
TPXCF 25000	250,000	200,000	500,000	433,000	353,500	4.07	5.0 - 10"
TPXCF 27500	275,000	220,000	550,000	476,300	388,850	4.61	6.0 - 12"
TPXC 30000	300,000	240,000	600,000	519,600	424,200	4.92	6.0 - 12"
TPXC 40000	400,000	320,000	800,000	692,800	565,600	6.54	7.0 - 14"
TPXCF 50000	500,000	400,000	1,000,000	866,000	707,000	8.15	7.0 - 14"
TPXCF 60000	600,000	480,000	1,200,000	1,039,000	848,000	10.20	8.0 - 16"

ROPE (SYNTHETIC & FIBER)

Manila Rope	233 - 234
Dyneema Rope	235 - 238
Soft Shackles - Dyneema	239
Polypropylene Ropes	240 - 242
Sail Twine	242
Nylon Rope	243 - 245
Sash Cord	246
Nylon & Polyester Double Braid	247 - 248
Fid, Pushers, Needles & Sail Palms	251 - 252

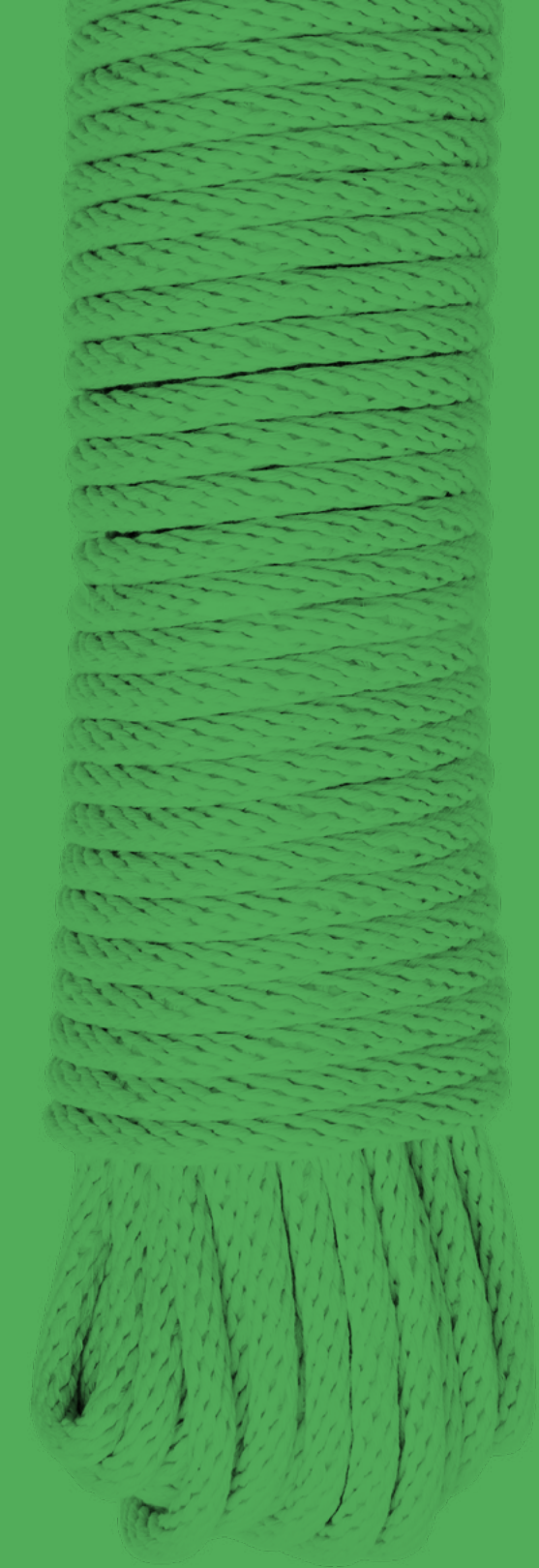

Manila rope is a type of rope made from Manila hemp. Manila hemp is a type of fiber obtained from the leaves of the abaca. It is not actually hemp, but named so because hemp was long a major source of fiber, and other fibers were sometimes named after it. The name refers to the capital of the Philippines, one of the main producers of abaca.

Manila rope is very durable, flexible and resistant to salt water damage, allowing its use in rope, hawsers, ship's lines, and fishing nets.

These ropes have passed all routine quality control inspection and testing procedures, and, when new, have a guaranteed breaking strength in accordance with the requirements of US Federal Specification TR-605B, Type M Class 1, Amendment 3.

ROPE - MANILA, 3-STRAND

- Material: Manila Hemp
- Standard: USFS TR-605B
- Specific Gravity: 1.38 / Sinks

Made of natural fiber it offers low stretch, superb knot holding ability and is biodegradable.



Diameter (in)	Length / Coil (ft)	Breaking Load (lb)	Avg. Weight / coil (lb)	Price / lb	Part Number
1/4	1250	540	25	10.56	112-7687A
5/16	1725	900	50	10.56	112-7687B
3/8	1220	1215	50	10.56	112-7687C
1/2	600	2385	45	10.56	112-7687D
5/8	600	3960	80	10.56	112-7687E
3/4	600	4860	100	10.56	112-7687F
7/8	600	6930	135	10.56	112-7687G
1	600	8100	162	10.56	112-7687H

*Actual Weight per coil may vary!

ROPE - MANILA, 4-STRAND

- Material: Manila Hemp
- Standard: USFS TR-605B
- Specific Gravity: 1.38 / Sinks



Diameter (in)	Length / coil (ft)	Breaking Load (lb)	Avg. Weight/ coil (lb)	Price / lb	Part Number
1	100	8100	28.35	10.56	112-7687H4S100
1	300	8100	82.70	10.56	112-7687H4S300
1-1/8	125	10 800	47.95	10.56	112-7687I4S125
1-1/8	150	10 800	54.95	10.56	112-7687I4S150
1-1/8	300	10 800	111.65	10.56	112-7687I4S300
1-1/4	300	12 150	129.60	10.56	112-7687J4S300

*Actual Weight per coil may vary!

ROPE - DSM DYNEEMA, 12-STRAND

DSM Dyneema is made from ultra-high molecular-weight polyethylene and is an extremely high-strength, low-stretch rope. Dyneema is stronger than steel cable, floats on water and is extremely resistant to abrasion. It is commonly used to replace steel cable when weight is an issue. It also makes an excellent material for winch cables.

In house splicing available - Call with your specifications

Oceanside Equipment offers Custom Made DSM Dyneema Rope Assemblies for heavy duty marine and industrial towing lines, towing hawser, mooring lines, dock lines, anchor lines, hawsers, construction rope, mining rope, oil field rope, offshore marine rope, oil platform rope, railroad rope, and rope for heavy duty industrial applications. All our lines are custom made-to-order per the customer's specifications.



Dia.(in)	Stock Colour
1/4 to 1/2	High Visibility Yellow
5/8 & Greater	Grey

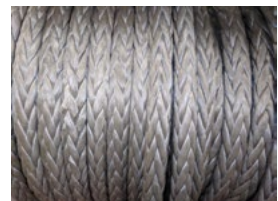

Additional colour options are available with custom orders.

ROPE - DSM DYNEEMA, 12-STRAND

- Material: Synthetic DSM Dyneema
- Standard: ISO 9554, 1346
- Finish: Dyed Colour
- Specific Gravity: 0.97 / Floats

Dia.(in)	Stock Colour
1/4 to 1/2	High Visibility Yellow
5/8 & Greater	Grey

Additional colour options are available with custom orders.





Dia. (in)	Dia. (mm)	MBL (lb)	Weight / 100 ft. (lb)	Price / ft	Part Number
3/16 - 1/4	5.5	7055	1.23	1.50	17-1/4"D12STR
5/16	8	13 007	2.30	Pricing on Request	17-5/16"D12STR
3/8	10	20 503	3.69	4.49	17-3/8"D12STR
7/16	11	25 353	4.70	5.71	17-7/16"D12STR
1/2	12	30 424	5.58	6.78	17-1/2"D12STR
9/16	14	39 904	7.39	Pricing on Request	17-9/16"D12STR
5/8	16	46 517	8.73	10.60	17-5/8"D12STR
3/4	18	65 257	12.36	15.01	17-3/4"D12STR
13/16	20	77 823	15.25	Pricing on Request	17-13/16"D12STR
53/64	21	82 012	17.00	Pricing on Request	17-53/64"D12STR
7/8	22	92 594	18.47	22.44	17-7/8"D12STR
1	24	108 026	21.76	26.45	17-1"D12STR
1-1/16	26	124 561	25.86	31.43	17-26MMD12STR
1-1/8	28	142 639	29.83	36.25	17-28MMD12STR
1-1/4	30	164 244	34.93	42.43	17-1-1/4"D12STR
1-5/16	32	185 849	39.57	48.11	17-1-5/16"D12STR
1-3/8	34	203 927	44.34	Pricing on Request	17-1-3/8"D12STR
1-1/2	36	222 667	48.37	58.79	17-1-1/2"D12STR
1-9/16	38	245 815	53.74	Pricing on Request	17-1-9/16"D12STR
1-5/8	40	268 964	59.11	71.83	17-1-5/8"D12STR
1-11/16	42	295 419	65.83	Pricing on Request	17-1-11/16"D12STR
1-3/4	44	321 875	72.41	88.97	17-1-3/4"D12STR
2	48	365 967	84.91	103.17	17-2"D12STR
2-1/16	50	399 036	93.37	Pricing on Request	17-2-1/16"D12STR
2-1/8	52	432 106	102.11	Pricing on Request	17-2-1/8"D12STR
2-1/4	56	498 244	118.23	143.69	17-2-1/4"D12STR
2-1/2	60	562 178	135.02	162.88	17-2-1/2"D12STR
2-5/8	64	626 112	151.81	Pricing on Request	17-2-5/8"D12STR
2-3/4	68	707 683	173.98	211.40	17-2-3/4"D12STR
3	72	789 254	195.48	237.60	17-3"D12STR
3-1/8	76	864 211	216.30	Pricing on Request	17-3-1/8"D12STR
3-1/4	80	936 964	237.13	288.25	17-3-1/4"D12STR
3-3/8	82	978 851	249.22	Pricing on Request	17-3-3/8"D12STR
3-1/2	86	1 062 627	273.40	Pricing on Request	17-3-1/2"D12STR
3-5/8	88	1 106 719	284.82	Pricing on Request	17-3-5/8"D12STR
3-3/4	92	1 192 699	310.35	Pricing on Request	17-3-3/4"D12STR
4	96	1 280 884	335.20	Pricing on Request	17-4"D12STR
4-1/4	104	1 523 392	405.73	Pricing on Request	17-4-1/4"D12STR
5	120	1 995 400	536.21	Pricing on Request	17-5"D12STR

- Items priced are in stock.

SLINGS - SLING CHART, DYNEEMA (SYNTHETIC ROPE), EYE & EYE



Tensile strengths are determined in accordance with Cordage Institute 1500.2. Test Methods for Fiber Rope. Minimum Breaking Loads (MBL) published assumes standard eye splices at each end of the rope.

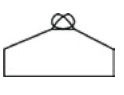



Nominal Size				 120° or >				
Dia. (in)	Dia. (mm)	MBL (lb)	Vertical	Choker	90°	60°	45°	30°
1	24	108026	21605	17284	43210	38889	30247	21605
1-1/16	26	124561	24912	19930	49824	44842	34877	24912
1-1/8	28	142639	28528	22822	57056	51350	39939	28528
1-1/4	30	164244	32849	26279	65698	59128	45988	32849
1-5/16	32	185849	37170	29736	74340	66906	52038	37170
1-3/8	34	203927	40785	32628	81571	73414	57100	40785
1-1/2	36	222667	44533	35627	89067	80160	62347	44533
1-9/16	38	245815	49163	39330	98326	88493	68828	49163
1-5/8	40	268964	53793	43034	107586	96827	75310	53793
1-11/16	42	295419	59084	47267	118168	106351	82717	59084
1-3/4	44	321875	64375	51500	128750	115875	90125	64375
2	48	365967	73193	58555	146387	131748	102471	73193
2-1/16	50	399036	79807	63846	159614	143653	111730	79807
2-1/8	52	432106	86421	69137	172842	155558	120990	86421
2-1/4	56	498244	99649	79719	199298	179368	139508	99649
2-1/2	60	562178	112436	89948	224871	202384	157410	112436
2-5/8	64	626112	125222	100178	250445	225400	175311	125222
2-3/4	68	707683	141537	113229	283073	254766	198151	141537
3	72	789254	157851	126281	315702	284131	220991	157851
3-1/8	76	864211	172842	138274	345684	311116	241979	172842
3-1/4	80	936964	187393	149914	374786	337307	262350	187393
3-3/8	82	978851	195770	156616	391540	352386	274078	195770
3-1/2	86	1062627	212525	170020	425051	382546	297536	212525
3-5/8	88	1106719	221344	177075	442688	398419	309881	221344
3-3/4	92	1192699	238540	190832	477080	429372	333956	238540
4	96	1280884	256177	204941	512354	461118	358648	256177
4-1/4	104	1523392	304678	243743	609357	548421	426550	304678
5	120	1995400	399080	319264	798160	718344	558712	399080

ROPE (SYNTHETIC & FIBER)

SLINGS - SLING CHART, DYNEEMA (SYNTHETIC ROPE), ENDLESS GROMMET

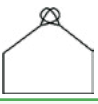
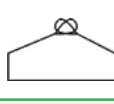

Tensile strengths are determined in accordance with Cordage Institute 1500.2. Test Methods for Fiber Rope. Minimum Breaking Loads (MBL) published assumes standard eye splices at each end of the rope.

Nominal Size				 120° or >				
Dia. (in)	Dia. (mm)	MBL (lb)	Vertical	Choker	90°	60°	45°	30°
1	24	178243	35649	28519	64167	54542	44917	35649
1-1/16	26	205526	41105	32884	73989	62891	51792	41105
1-1/8	28	235354	47071	37657	84728	72018	59309	47071
1-1/4	30	271003	54201	43360	97561	82927	68293	54201
1-5/16	32	306651	61330	49064	110394	93835	77276	61330
1-3/8	34	336480	67296	53837	121133	102963	84793	67296
1-1/2	36	367401	73480	58784	132264	112425	92585	73480
1-9/16	38	405595	81119	64895	146014	124112	102210	81119
1-5/8	40	443791	88758	71006	159765	135800	111835	88758
1-11/16	42	487441	97488	77991	175479	149157	122835	97488
1-3/4	44	531094	106219	84975	191194	162515	133836	106219
2	48	603846	120769	96615	217384	184777	152169	120769
2-1/16	50	658409	131682	105346	237027	201473	165919	131682
2-1/8	52	712975	142595	114076	256671	218170	179670	142595
2-1/4	56	822103	164421	131536	295957	251563	207170	164421
2-1/2	60	927594	185519	148415	333934	283844	233754	185519
2-5/8	64	1033085	206617	165294	371911	316124	260337	206617
2-3/4	68	1167677	233535	186828	420364	357309	294255	233535
3	72	1302269	260454	208363	468817	398494	328172	260454
3-1/8	76	1425948	285190	228152	513341	436340	359339	285190
3-1/4	80	1545991	309198	247358	556557	473073	389590	309198
3-3/8	82	1615104	323021	258417	581437	494222	407006	323021
3-1/2	86	1753335	350667	280534	631200	536520	441840	350667
3-5/8	88	1826086	365217	292174	657391	558782	460174	365217
3-3/4	92	1967953	393591	314873	708463	602194	495924	393591
4	96	2113459	422692	338153	760845	646718	532592	422692
4-1/4	104	2513597	502719	402175	904895	769161	633426	502719
5	120	3292410	658482	526786	1185268	1007477	829687	658482

SOFT SHACKLES

With the rich experience in manufacturing high-end product (e.g. UHMWPE) for more than 20 years, FBR Soft Shackles offer outstanding strength at a light weight to replace conventional steel shackles or other connection types.

FBR Soft Shackles are made of 100% UHMWPE. Imported coating makes them very resistant to abrasion and UV-radiation, it can also be customized and comes with a protection sleeve for additional protection against wear and tear.

Special Features:

- Extremely lightweight
- Easy to handle
- High breaking strength
- No stretch
- Good corrosion resistance.

Application:

- ATV & SUV Off-road recovery
- Boating
- Camping
- Personal watercraft
- 5-1 for lifting
- 3-1 for towing



SHACKLE - SOFT, SYNTHETIC

Diameter (in)	Length (in)	Colour	MBS (lbs)	Price / ea.	Part Number
5/16	10"	Yellow	24 200	53.98	17-5/16X10SS
3/8	10"	Yellow	30 800	61.69	17-3/8X10SS
1/2	10"	Yellow	41 800	69.39	17-1/2X10SS
9/16	10"	Yellow	55 100	77.09	17-9/16X10SS
5/8	18"	Yellow	74 900	138.83	17-5/8X18SS
3/4	18"	Yellow	92 500	151.94	17-3/4X18SS
7/8	24"	Yellow	136 600	177.03	17-7/8X24SS

*Other sizes are available upon request.

Lengths are measured from pull to pull when joined.

Use of soft shackles below a D/d ratio of 3 is not recommended.

ROPE - OCEAN STEEL LINE, 3-STRAND, AQUA

- Material: Synthetic Polypropylene
- Standard: ISO 9554, 1346
- Finish: Dyed Aqua Green, with Yellow Tracer
- Lay: Medium
- Specific Gravity: 0.91 / Floats
- Sold in full coils only



Dia. (in)	Qty. / Coil (ft)	MBL (lb)	Est. Weight / Coil (lb)	Price / lb	Part Number
1/4	1200	1670	13.2	4.95	17-1/4"AGML1200
5/16	1200	3170	24.2	4.95	17-5/16"AGML1200
3/8	1200	3920	35.2	4.95	17-3/8"AGML1200
7/16	1200	4800	44	4.95	17-7/16"AGML1200
1/2	1200	6870	62	4.95	17-1/2"AGML1200
9/16	1200	9560	72.7	4.95	17-9/16"AGML1200
5/8	1200	11 500	92.4	4.95	17-5/8"AGML1200
3/4	1200	14 600	119	4.95	17-3/4"AGML1200
7/8	600	21 100	88.2	4.95	17-7/8"AGML600
1	600	24 300	104.7	4.95	17-1"AGML600
1-1/4	600	34 600	185	4.95	17-1-1/4"AGML600
1-1/4	1200	34 600	370	4.95	17-1-1/4"AGML1200
1-1/2	600	53 300	236	4.95	17-1-1/2"AGML600
2	720	87 800	547	4.95	17-2"AGML720

Polypropylene (PP), also known as polyprop, is a thermoplastic polymer, made by the chemical industry and used in a wide variety of applications. It is rugged and unusually resistant to many chemical solvents, bases and acids. Polypropylene rope has nearly twice the strength of Manila rope when compared size to size. The rope has positive buoyancy (floats) and doesn't absorb water, rot or decay. It's resistant to acid, alkali and most chemicals. When not in use the rope should be stored away from direct sun light. Recommended usages are mooring, dock and anchor line, boat life-line, tarpaulin line, tent tie down, pool barrier line, public utility and general use in home, farm and industry.

ROPE - OCEAN STEEL LINE, 8-STRAND, GOLD

- Material: Synthetic Polypropylene
- Standard: ISO 2307
- Finish: Dyed Gold, with Red Tracer
- Lay: Medium
- Specific Gravity: 0.91 / Floats
- Sold in full coils only



Circ. (in)	Dia. (in)	Qty. / Coil (ft)	Weight / 100 ft (lb)	Breaking Strength (lb)	Est. Weight / Coil (lb)	Price / lb	Part Number
5	1-5/8	720	53.1	62 500	382	5.95	8-5"SDAN
6	2	720	80.2	91 400	577	5.95	8-6"SDAN
7	2-1/4	720	108.5	120 600	781	5.95	8-7"SDAN
8	2-5/8	720	141.1	155 000	1015	5.95	8-8"SDAN
9	3	720	178.1	197 100	1282	5.95	8-9"SDAN
10	3-1/4	720	220	235 000	1585	5.95	8-10"SDAN

ROPE - OCEAN STEEL LINE, 3-STRAND, YELLOW

- Material: Synthetic Polypropylene
- Standard: ISO 9554, 1346
- Finish: Dyed Yellow, with Blue Tracer
- Lay: Medium
- Specific Gravity: 0.91 / Floats
- Sold in full coils only



Diameter (in)	Qty / Coil (ft)	Breaking Strength (lb)	Est. Weight / Coil (lb)	Price / lb	Part Number
1/4	1200	1670	13.3	4.95	8-1/4"SDAN
5/16	1200	3170	26.4	4.95	8-5/16"SDAN
3/8	1200	3920	35.3	4.95	8-3/8"SDAN
1/2	600	6870	30.9	4.95	8-1/2"SDAN
5/8	600	11 500	46.3	4.95	8-5/8"SDAN
3/4	600	14 600	59.5	4.95	8-3/4"SDAN
7/8	600	21 100	97	4.95	8-7/8"SDAN
1	600	24 300	105.8	4.95	8-1"SDAN

ROPE - POLYPROPYLENE, JUMBO, 3-STRAND, YELLOW

- Jumbo Plastic Reels,
- General Purpose, commercial grade
- Material: Synthetic Polypropylene
- Standard: ISO 2307
- Finish: Dyed Yellow
- Lay: Soft
- Specific Gravity: 0.91 / Floats



Diameter (in)	Qty. / Reel (ft)	Break Load (lb)	Price / Reel	Part Number
3/16	2125	720	66.34	8-3/16"PJR
1/4	1300	1050	66.34	8-1/4"PJR
5/16	975	1700	66.34	8-5/16"PJR
3/8	630	2450	66.34	8-3/8"PJR
1/2	335	3600	66.34	8-1/2"PJR
5/8	200	5500	66.34	8-5/8"PJR
3/4	125	8000	66.34	8-3/4"PJR

ROPE - SAIL TWINE, WAXED

- Material: Synthetic Fiber
- Finish: Waxed

Size	Price / ea	Part Number
1/4 lb	46.92	125-1/4LBST



* For whipping rope ends, splicing, reinforcing sail fittings and general sail sewing and repair!

Nylon is a generic designation for a family of synthetic polymers known generically as polyamides, first produced on February 28, 1935, by Wallace Carothers at DuPont's research facility at the DuPont Experimental Station. Nylon is one of the most commonly used polymers. Nylon rope exceeds twice the strength of Manila rope. It has high elongation (under load) when compared to other synthetic ropes. Nylon has higher energy absorption under shock and good abrasion resistance. When combined, these characteristics make nylon rope the best in handling compared to other synthetics. It's utilized extensively in marine use such as mooring lines, towing slings, commercial fishing, utility rope, leisure boat, sailing etc. This rope does not float.

ROPE - NYLON, 8-STRAND

- Material: Synthetic Polymer
- Standard: ISO 9554, 1140
- Tested to: ISO 2307
- Finish: White
- Lay: Medium
- Specific Gravity: 1.14 / Sinks



ROPE (SYNTHETIC & FIBER)

Circ. (in)	Diameter (in)	Qty. / Coil (ft)	Est. Weight / Coil (lb)	Break Strength (lb)	Price / lb	Part Number
8	2-5/8	720	1219	162 000	Pricing on Request	8-8"NYLON
9	3	720	1543	200 000		8-9"NYLON

*Actual Weight per Coil may vary!

ROPE - NYLON, 3-STRAND

- Material: Synthetic Polymer
- Standard: ISO 9554, 1140
- Tested to: ISO 2307
- Finish: White
- Lay: Medium
- Specific Gravity: 1.14 / Sinks
- Sold in full reels only



Diameter (in)	Est. Qty. / Reel (ft)	Est. Weight / Reel (lb)	Break Loads (lb)	Price / lb	Part Number
1/4	1200	18.74	1540	11.46	8-1/4"NYLON
5/16	1200	33.06	2860	11.46	8-5/16"NYLON
3/8	1200	50.7	3696	11.46	8-3/8"NYLON
1/2	600	42.98	6600	11.46	8-1/2"NYLON
5/8	600	63.92	11 660	11.46	8-5/8"NYLON
3/4	600	90.37	16 500	11.46	8-3/4"NYLON
7/8	600	121	22 000	11.46	8-7/8"NYLON
1	600	160	28 380	11.46	8-1"NYLON
1-1/8	600	204	34 760	11.46	8-1-1/8"NYLON
1-1/4	600	240	44 000	11.46	8-1-1/4"NYLON
1-1/2	600	330	59 620	11.46	8-1-1/2"NYLON

*Actual Weight per Coil may vary!

ROPE - NYLON, JUMBO, 3-STRAND

- Jumbo Plastic Reels
- Material: Synthetic Polymer
- Standard: ISO 9554, 1140
- Tested to: ISO 2307
- Finish: White
- Lay: Soft
- Specific Gravity: 1.14 / Sinks
- Sold in full reels only



Diameter (in)	Qty. / Reel (ft)	Break Load (lb)	Price / Reel	Part Number
3/16	2125	1000	323.12	8-3/16"NJR
1/4	1300	1650	323.12	8-1/4"NJR
5/16	975	2550	323.12	8-5/16"NJR
3/8	630	3700	323.12	8-3/8"NJR
1/2	335	6400	323.12	8-1/2"NJR
5/8	200	10 400	323.12	8-5/8"NJR
3/4	125	14 200	323.12	8-3/4"NJR

ROPE - SASH CORD, COTTON

- Material: Synthetic Cotton
- Finish: White/Beige
- Specific Gravity: 1.38 / Sinks



Size	Hank length	Price / ea.	Part Number	10 (lb) reel footage	Price / ea.	Part Number	
# 6	3/16"	100 ft	17.53	125-6SCH	760 ft	155.15	125-6SCR
# 7	7/32"	100 ft	24.91	125-7SCH	660 ft	155.15	125-7SCR
# 8	1/4"	100 ft	19.27	125-8SCH	500 ft	155.15	125-8SCR
# 10	5/16"	100 ft	29.48	125-10SCH	350 ft	155.15	125-10SCR
# 12	3/8"	100 ft	38.57	125-12SCH	240 ft	155.15	125-12SCR
#16	1/2"	100 ft	58.37	125-16SCH			

This cord has an interlocking solid braid construction, a durable composite cotton cover, and is polished with a weather resistant coating. It also has a synthetic reinforcing core. Hanks are 100' connected and shrink wrapped.

ROPE - NYLON DOUBLE BRAIDED 2-1, OCEAN STEEL LINE

- Material: Synthetic Polymer
- Standard: ISO 9554, 10554
- Tested to: ISO 2307
- Finish: White with Yellow Tracer
- Lay: Soft
- Specific Gravity: 1.14 / Sinks



Dia. (in)	Qty. / Coil (ft)	Breaking Strength Min. (lb)	Est. Weight / Coil (lb)	Price / Coil	Part Number
3/8	1200	5000	44	605.45	17-3/8"NDBLB
1/2	600	8000	37.4	514.63	17-1/2"NDBLB
5/8	600	14 800	70.4	968.72	17-5/8"NDBLB
3/4	600	19 000	85.5	1,180.63	17-3/4"NDBLB
1	600	33 500	149.6	2,058.53	17-1"NDBLB
1-1/4	600	52 000	235.4	3,239.15	17-1-1/4"NDBLB
1-1/2	600	74 000	358	4,440.30	17-1-1/2"NDBLB
2	600	131 000	636	7,932.00	17-2"NDBLB

ROPE - POLYESTER DOUBLE BRAIDED 2-1, OCEAN STEEL LINE

- Material: Synthetic Polyester
- Standard: ISO 9554, 10554
- Tested to: ISO 2307
- Finish: White with Blue Tracer
- Lay: Soft
- Specific Gravity: 1.38 / Sinks



Dia. (in)	Qty. / Coil (ft)	Breaking Strength Min. (lb)	Est. Weight / Coil (lb)	Price / Coil	Part Number
3/8	1200	4900	54	751.40	17-3/8"PDBLB
1/2	600	10 400	48	617.40	17-1/2"PDBLB
5/8	600	16 100	75	914.00	17-5/8"PDBLB
3/4	600	18 000	107.4	1,207.97	17-3/4"PDBLB
1	600	32 000	191.4	2,308.56	17-1"PDBLB
1-1/4	600	49 000	298.8	3,642.60	17-1-1/4"PDBLB

ROPE TYPES - SYNTHETIC

OLETEC-12™

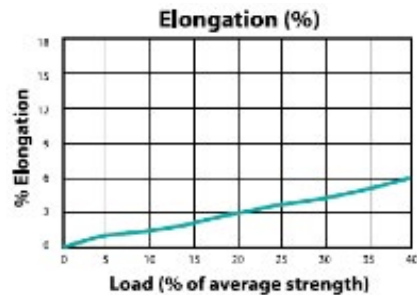

FEATURES:

- Non-Rotating
- Torque Free
- Lightweight
- High Strength
- UV Stabilized
- High Dielectric
- High Visibility
- No Water Absorption
- Specific Gravity of 0.99



OLETEC-12™ is a hollow braided 12 strand rope using 100% polyolefin high tenacity co-polymer fiber. It is designed with single or two ply construction depending upon nominal size. Oletec 12 is designed for commercial and marine applications where an easily handled, high strength, floating rope is required. It has excellent abrasion resistance, will not mildew or rot, and is easily spliced.

Oletec-12 meets or exceeds dielectric requirements per ASTM F1701-05

NOVABLUE™

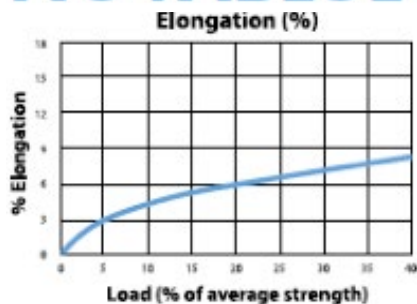

FEATURES:

- Specific Gravity of 1.38
- Low Elongation
- High Strength
- Excellent Dielectrics
- Abrasion Resistance
- UV Stabilized Cover
- Urethane Coated Cover Available



NOVABLUE™ is our premium double braided polyester rope designed for general marine, industrial, and commercial use where low elongation, high strength, and abrasion resistance are required. Constructed from the highest quality UV stabilized yarns, Novabue's balanced core and cover construction insures easy splicing. It can be easily identified by a single blue tracer in the cover. Diameters over 1" are solid white.

NovaBlue meets or exceeds (on request) US MIL Spec # MIL-R-24677 Cdn MIL Spec # 40-GP-16M

NOVAGOLD™

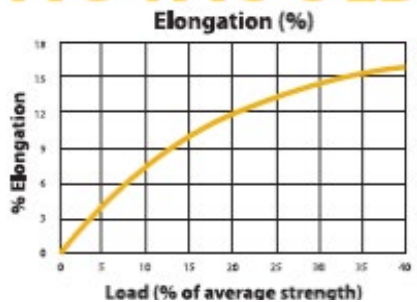

FEATURES:

- Specific Gravity of 1.14
- High Energy Absorption
- Controlled Elongation
- High Strength
- Abrasion Resistance
- Mildew Resistance
- Urethane Coated Cover Available



NOVAGOLD™ is our premium double braided nylon rope designed for general marine, industrial, and commercial use where controlled elongation, high strength, and abrasion resistance are required. It is constructed from the highest quality yarns to resist mildew, rot, and most chemicals. Novagold's balanced core and cover construction insure easy splicing. It can be easily identified by a single gold tracer in the cover. Diameters over 1" are solid white.

NovaGold meets or exceeds (on request) US MIL Spec # MIL-R-24050D Cdn MIL Spec # 40-GP-16M

SPECTEC-12™

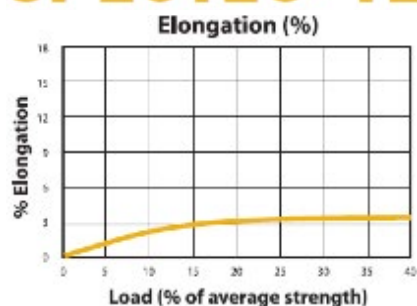

FEATURES:

- Specific Gravity of 0.98
- Very High Strength
- Low Elongation
- Easy Handling
- Fully Spliceable



SPECTEC-12™ is a hollow braided 12-strand rope using 100% Spectra fiber. It is designed with single ply construction up to 1½" nominal size and two ply in larger diameters. Spectec-12 yields one of the highest strength to weight ratios available in a synthetic rope. It comes standard with a urethane coating that provides additional abrasion resistance while remaining easy to handle and splice.

DYNEEMA - 12

Dyneema-12 is a hollow braided 12-strand rope made from Dyneema fiber. It has a high weight to strength ratio with very little stretch. Custom slings are available ready made from manufacturer.

ROPE TYPES - SYNTHETIC

Size		ROPE TYPE									
Dia. (in)	Circ. (in)	OLTEC-12™		NOVABLUETM™		NOVAGOLD™		SPECTEC-12™		DYNEEMA- 12	
		Est. Weight (lb) / 100 ft	Average Tensile Strength (lb)	Est. Weight (lb) / 100 ft	Average Tensile Strength (lb)	Est. Weight (lb) / 100 ft	Average Tensile Strength (lb)	Est. Weight (lb) / 100 ft	Average Tensile Strength (lb)	Est. Weight (lb) / 100 ft	Average Tensile Strength (lb)
1/8"								0.5	1,600	0.5	2,500
3/16"				1.0	1,175			1.0	3,200	1.0	5,400
1/4"	3/4"	1.1	1,500	2.0	1,950	1.7	2,400	1.7	6,500	1.7	8,600
5/16"	1"	1.7	2,400	3.1	3,500	2.6	3,400	2.9	9,500	2.7	13,700
3/8"	1-1/8"	2.7	3,500	4.5	4,900	3.7	5,000	3.8	14,200	3.6	19,600
7/16"	1-1/4"	3.5	4,400	6.1	6,200	5.0	6,500	4.3	16,500	4.2	23,900
1/2"	1-1/2"	4.9	6,000	8.0	10,400	6.4	8,000	6.4	24,000	6.4	34,000
9/16"	1-3/4"	6.8	8,000	10.1	10,800	8.4	11,800	7.5	28,000	7.9	40,500
5/8"	2"	8.7	9,900	12.5	15,500	12.0	14,800	10.6	41,000	10.2	52,800
3/4"	2-1/4"	10.9	12,000	17.9	18,000	16.0	19,000	13.2	49,000	13.5	64,400
7/8"	2-3/4"	14.4	15,800	24.4	24,000	21.8	28,000	19.5	68,000	19.5	90,800
1"	3"	20.5	21,000	31.9	32,000	26.0	33,500	23.3	79,000	21.8	109,000
1-1/8"	3-1/2"	25.0	26,000	40.0	39,500	35.8	45,000	32.0	100,000	31.9	148,000
1-1/4"	3-3/4"	27.4	28,500	49.8	49,000	41.0	52,000	36.1	110,000	36.2	165,000
1-5/16"	4"	32.0	32,800	55.0	53,500	46.8	59,000			41.8	184,000
1-3/8"										45.0	205,000
1-1/2"	4-1/2"	40.0	40,000	71.8	65,000	59.8	74,000			51.7	228,000
1-5/8"	5"	51.0	50,000	84.0	77,500	74.0	91,500				
1-3/4"	5-1/2"	59.0	58,000	97.7	89,500	89.0	111,000				
2"	6"	72.0	69,000	128.0	110,000	106.0	131,000				

Note this is average tensile strength and not minimum tensile strength

FID - NORWEGIAN

- Stainless steel fid with hardwood handles for making eye, end, and running splices in twisted line. Hollow backside for ease of threading.

Size	Price / ea.	Part Number
Small	21.68	6-SM304FID
Large	28.00	6-LG304FID



SAIL NEEDLE

- Used for Sail Repair

Size	Length (in)	Price / ea.	Part Number
11	3-1/2	3.28	98-11SN
12	3-3/8	3.28	98-12SN
13	3	3.28	98-13SN
14	2-3/4	3.28	98-14SN
15	2-1/2	3.28	98-15SN
16	2-3/8	3.28	98-16SN



SAIL PALMS

- Leather rawhide palm with thimble in left & right
- Designed to provide user with protection while sewing.

Type	Price / ea.	Part Number
Right hand	33.67	98-SPRH
Left hand	33.67	98-SPLH



SPLICING - PUSHER & FIDS - ALUMINUM

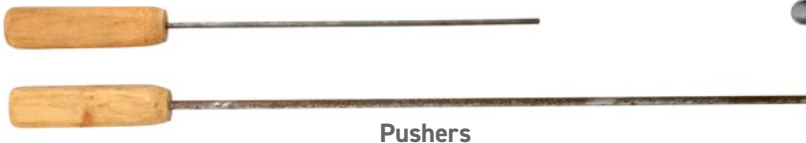

Pushers

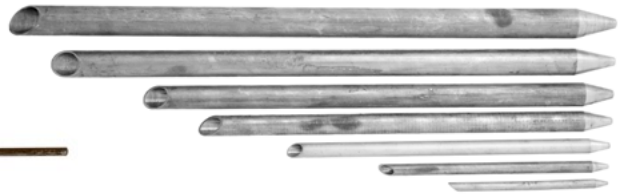

Fids

- Designed to splice double braided rope, measurements are designed in fid lengths so it is important to get the right size fids for the rope being spliced. Pushers are used to push strands of rope into the splice and are offered in two sizes for small or large ropes.

Size Rope (in)	Type	Length (in)	Price / ea.	Part Number
1/4 to 1/2	Pusher	11-1/2	8.40	22-SMPUSH
9/16 to 1	Pusher	17	14.08	22-LGPUSH
1/4	Fid	5-1/2	12.59	22-1/4"ATF
3/8	Fid	7-3/4	14.69	22-3/8"ATF
1/2	Fid	11	16.80	22-1/2"ATF
5/8	Fid	14	21.03	22-5/8"ATF
3/4	Fid	15-3/4	25.23	22-3/4"ATF
7/8	Fid	19	31.56	22-7/8"ATF



WIRE ROPE END TERMINATORS

Rigging Equipment.....	256 - 258
Die Lube.....	259
Wire Rope Sleeves, Ferrules, Stops & Buttons	260 - 266
Marlin Spikes.....	266
Thimbles.....	267 - 271
Choker Buttons & Hooks	272
Go-No-Go Guages & Cable Joiners	272 - 273
Wire Rope Clips	274 - 276
Spelter Sockets	277 - 281
Socket Lock, Broom Degreaser & Socketing Putty.....	282 - 283
Swage, & Wedge Sockets	284 - 287



OCEANSIDE
EQUIPMENT LIMITED
A BISHOP LIFTING COMPANY

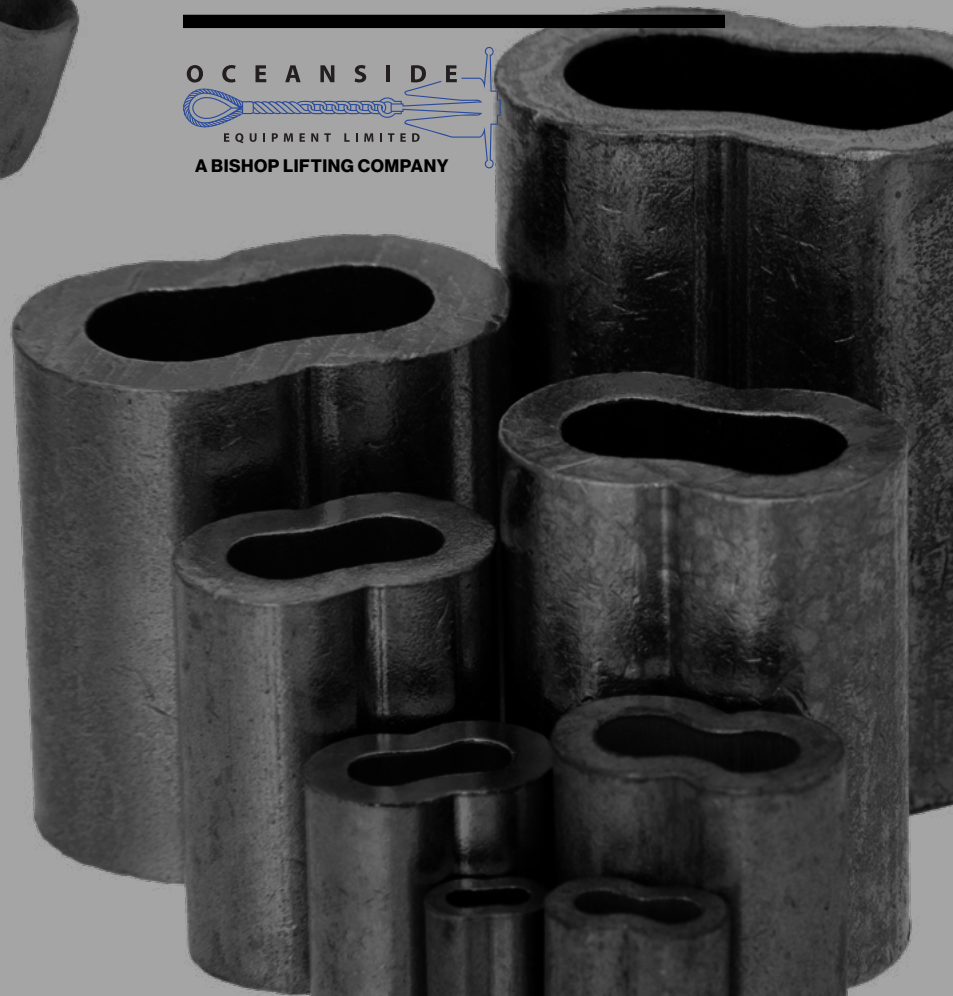

RIGGING EQUIPMENT



Wirop Industrial Company Ltd was established in 1979 by Mr. Ben Chiu. Our modern factory is located in Kaohsiung, the southern hub of Taiwan, close to the international airport, harbor and rail ways. We have been providing for the needs of wire rope fabricators for more than 35 years.

The main products we make are hydraulic swaging machines (wire rope clamping machines) [capacity 30 ton - 4000 ton for wire rope [1mm - 120mm], dies, horizontal testing benches (capacity: 50 ton-3000 ton), annealing and tapering machines, recoiling machines, marking machines, auto-measuring & cutting machines as well as others. Besides this, we offer Aluminum ferrules according to EN 13411-3 (DIN 3093), Flemish eye steel sleeves from 1/4" to 6" and other swaging products for wire ropes of different kinds of material, i.e. copper, stainless steel, swage sockets and thread stud terminals.



Wire Rope Grip System



200 ton x 22.5 m
Horizontal Tension tester



Power Hydraulic Pump Unit



Measuring &
Cutting Machine



Hand Press Portable

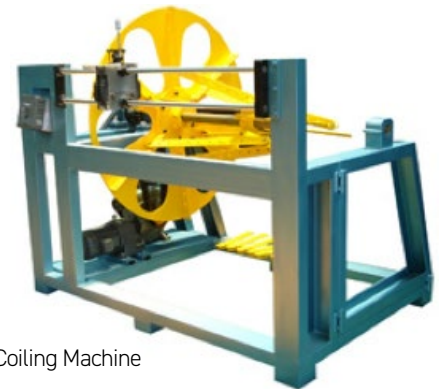

Coiling Machine



Table Swager



Portable Hydraulic Press



Portable Hydraulic Wire Rope Cutter



Annealing & Tapering Machine

FAST FLEMISH SWAGE SYSTEM

This swaging is not only faster and more efficient but it greatly reduces the possibility of over or under swaging the sleeve. In the first swage step, the sleeve cannot be over swaged because of the precise notching of the die; the second step allows a controlled closing of the dies to slightly less than full closure whereby the third and final step allows full closure of the dies. The end result is a nearly smooth round swaged sleeve without the usual "wrinkles" one gets from the conventional swaging methods.

Conventional swaging of a round carbon steel sleeve on the wire rope has repeated multiple closing of the dies until the sleeve is completely swaged. This "multi-swage" system of swaging requires several die closures that are dependent on the wire rope diameter. On rope diameters 1" and larger, two dies are necessary to swage the sleeve, requiring an extra die change. The total number of die closures for sleeves larger than 1" diameter can be as many as ten total closures for the two sets of dies.

In the Wirop "Fast Flemish Swage" system not only are the number of swages minimized and simplified, over and under swaging are eliminated, multi-swages on sleeves over 1" in size are greatly reduced. Die changes from 1st open stage to 2nd taper is also eliminated.

Fast Flemish Swage system is available up to 2-1/2" sleeve diameters. Bigger sizes are under development.

Wirop swaging machines are packed with functions that add to the efficiency and speed in swaging. Should the users choose to use the machine to swage sleeves conventionally; the operator is able to adjust the hydraulic pressure simply by setting the sleeve size on a round dial. This function alone eliminates the guesswork for how much pressure to apply for a given size sleeve. Another simple dial but extremely useful function allows the die openings to be fixed to any desired amount of opening. Aluminium oval ferrules are swaged in just one step as the dies have cutting edges that remove the excess flash. Fully automatic one button swage for Aluminium oval ferrules is a huge time saver. In the automatic mode the dies close and open with the push of a button. The dies opening can be pre-set to just enough space to allow the swage sleeve to be removed, again saving time to insert the next sleeve to be swaged quickly and efficiently.

WIROP "FAST FLEMISH SWAGE" swaging instruction

(Instructions vary for different size sleeves)

1. Place the Flemish Eye steel sleeves on the "Flat Side" (Notched Side) by lining the center line of sleeves with the reference center line (see Figure A) of the die as shown in Figure B
2. Close the dies completely. The sleeves will be swaged to 80% of diameter A and turn into an oval shape as in Figure C
3. Turn the swaged sleeve 90 degrees and place the sleeve on the die as shown below in Figure D
4. Close the die until gap is about 0.1 A as shown in Figure E
5. Turn the sleeve 45 degree again and close the dies completely as shown in Figure F

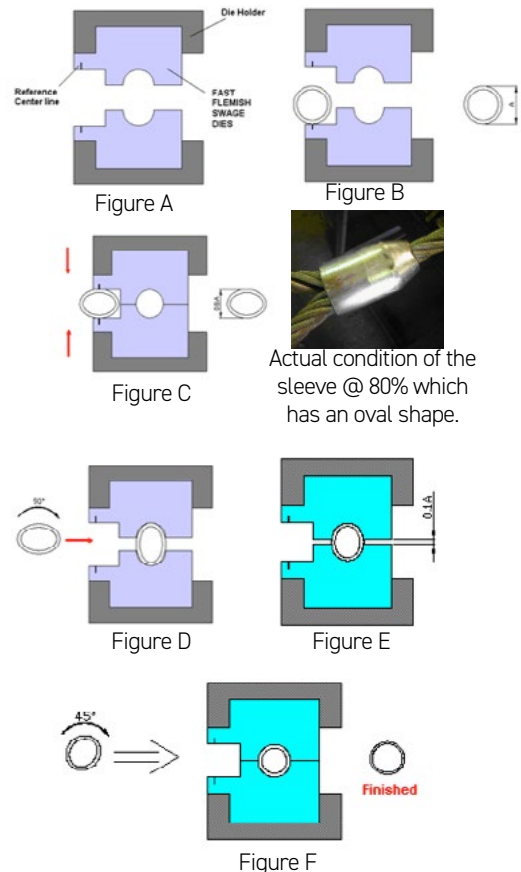

RIGGING EQUIPMENT



Description	Value
Column	1
Max. Pressure Capacity	1350 (t)
Power Supply	25 Hp
Max. Oil Pressure	300 kg/cm2
Max. Piston Stroke	120 mm
Unloaded Speed	8.1 mm/s
Loaded Speed	1.2 mm/s
Reversing Speed	12.4 mm/s
Operating Height	1250 mm
Dimensions L*W*H	3100*1050*2480
Approximate Weight	19000 kg



WP-1300C

Capacity		
Aluminium Ferrules (one/multi-stage)		# 58 / # S66
Flemish Eye Steel Sleeve		3-1/4"
Swage Sockets	Full Shank	1-1/8"
	Progressive	2"



WP-600CN

SWAGING MACHINE NEW-TECH "SMART PRESS"

Wirop is pleased to introduce a new generation swaging machine.

NEW CONCEPT:

HMI (Human Machine Interface), PLC, Pressure Sensor, Temperature Sensor and Special design die No. sensor system combined as Wirop NEW-TECH swaging machine. The dies No. can be detected by Special Sensor System on die holder and show the Die No. on screen.

NEW OPERATION MODE:

The FUZZY mode allows swaging pressure to be set automatically according to the detected Die No. by Special Sensor System. The operator does not need to set the swaging pressure manually.

SELF-DETECTION:

The troubles such as overload, high oil temperature, imperfect die installation and so on can be detected and appear on the troubleshooting screen.

ON-LINE HELP:

On-line Help is available. The swaging information is stored in memory. It is easy to get the swaging information such as splicing table, swaging method, and operation menu on screen.



REELING MACHINES WIROP SHAFTLESS

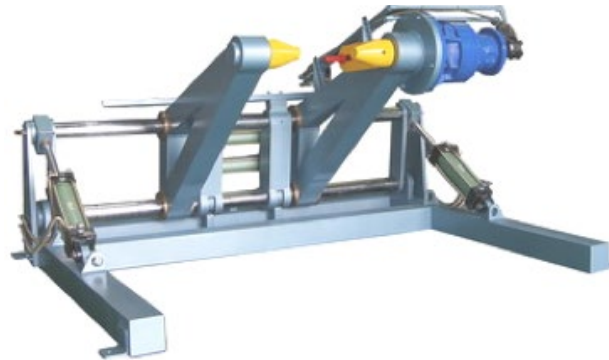

Model	WPRC-3500	WPRC-4500	WPRC-8000
Power supply, (HP)	15 HP/4P	15 HP/4P	25 HP/4P
Outside diameter of reels, (mm)	500~1500	500~1700	500~2100
Width of reels, (mm)	400~1500	400~1500	400~1700
Drum weight with wire rope wound on, (kg)	3500	4500	8000
Inner reel hole diameter (stepped up type)	30~90mm	30~90mm	30~90mm
Adjustable speed, (RPM)	0~40	0~40	0~45
Oil tank capacity, Liter (l)	330	350	400
Dimensions (W x L x H) (mm)	2600x3000x1200	2800x3000x1200	2800x3500x1350

* WIROP® reserves the right to change specifications.

- Easier loading and unloading
- User friendly operation control
- Motorized opening /closing of pintles with mechanical torque limiters (by hydraulic cylinders)
- Motorized lifting and lowering of pintles to fit appropriate reels (by hydraulic cylinders)
- Adjustable winding speed and the rotation direction (forward or reverse) can be switched
- The system has braked control in the winding process to avoid over coiling
- Wireless remote control box



OPTIONAL EQUIPMENT:

Power Traverse System



Collapsible Coiling Arm



SWAGING MACHINES FROM 150 TE TO 4,000 TE



WP-150C



WP-300C



WP-600C



WP-300H



WP-600H



WP-1000



WP-1500



WP-2000



WP-3000/4000



WiroP Swag Dies



Swage Socket Dies



Flemish Eye Steel Sleeve Dies
(Fast Flemish Wage System)

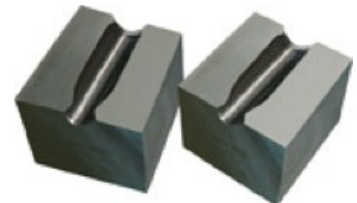

Flemish Eye Steel Sleeve Dies
(Conventional)

DIE LUBE - SWAGING LUBRICANT

EXTREMELY LOW COEFFICIENT OF FRICTION FOR HIGH PRESSURE APPLICATIONS

- Specially formulated to prevent pre-mature wearing of dies
- Minimizes friction to allow swage fitting to "flow" while pressing
- Helps to produce higher quality surface finish on swage fitting
- Lubrication of swaging dies is necessary to properly press all types of swage fittings

Size	Price / ea.	Part Number
1 gallon pail	570.36	38-DIELUBE1G
5 gallon pail	2,700.15	38-DIELUBE5G



What happens during the swaging process?

While being pressed, swage fittings will actually elongate. After swage lengths are always longer than before swage lengths. This shows that there is heat and wear being generated by metal to metal contact under great pressure. By design, dies are harder than swaging fittings. Despite the difference in hardness between the dies and swage fittings, the dies will wear during the swaging process.

Why is it necessary to lubricate while swaging?

Because you have two metal surfaces grinding against each other under great pressure, a lubricant is required to minimize the friction between the surfaces. Lubrication assists the metal of the swage fitting to flow more freely and therefore minimize wear on the die surface. It is important to note that not only does lubricating minimize die wear; it promotes the

elongation of swage fittings rather than squeezing the metal of the fitting to the sides which then produce excessive metal "flesh". This metal "flesh" tends to produce an ugly finish on the fitting and can cause the fitting to crack.

What makes "Die-Lube" such a good lubricant for its application?

"Die-Lube" is formulated to possess a high coefficient of friction under high pressure, compressive loads. This means friction is absolutely minimized. Common heavy greases are certainly better than no lubrication, but most grease is not formulated to perform under high pressure and for dies with swage fittings. Besides being a quality high pressure lubricant, "Die-Lube" is affordably priced and will protect the investment you have in your dies.

SLEEVE (FERRULE) - FLEMISH SPLICE, CARBON STEEL

Larger sizes available on request to 6" diameter wire rope.

Wire rope Flemish Splice Steel Sleeves are stamped with size and PIC (product identification code) to assure traceability and come with a galvanized finish for prolonged life in harsh environments. When a self colored and galvanized sleeve are left out in the elements for a prolonged period of time the results are obvious. The self colored sleeve shows severe signs of surface rust and pitting while the galvanized sleeve shows little to no effect. Each sleeve shown below (center) was put side by side and left outside for one month.



Wire Rope Size (in)	Max. after swage Dim. (in)	Weight (lb) / 100 pcs	Dimensions (mm)					Qty./ box	Price / ea.	Part Number
			A	B	C	D	E			
1/4	0.57	5	1.00	0.66	0.47	0.31	0.28	1000	1.78	139-1/4"
5/16	0.75	14	1.50	0.91	0.62	0.38	0.44	300	2.48	139-5/16"
3/8	0.75	14	1.50	0.91	0.66	0.47	0.39	350	2.48	139-3/8"
7/16	1.01	33	2.00	1.22	0.85	0.53	0.65	130	4.97	139-7/16"
1/2	1.01	29	2.00	1.22	0.91	0.63	0.56	150	4.40	139-1/2"
9/16	1.24	64	2.75	1.47	1.03	0.70	0.63	60	8.71	139-9/16"
5/8	1.24	56	2.75	1.47	1.09	0.75	0.63	70	8.02	139-5/8"
3/4	1.46	88	3.19	1.72	1.28	0.91	0.84	50	12.75	139-3/4"
7/8	1.68	131	3.56	2.03	1.53	1.03	1.00	30	21.91	139-7/8"
1	1.93	195	4.00	2.28	1.72	1.16	1.13	20	29.59	139-1"
1- 1/8	2.13	260	4.81	2.50	1.94	1.28	1.25	16	39.12	139-1-1/8"
1- 1/4	2.32	355	5.19	2.78	2.16	1.44	1.41	11	52.67	139-1-1/4"
1- 3/8	2.52	423	5.81	3.00	2.38	1.56	1.56	9	64.42	139-1-3/8"
1- 1/2	2.71	499	6.25	3.25	2.63	1.69	1.69	8	77.17	139-1-1/2"
1-3/4	3.1	805	7.25	3.84	3.13	1.94	1.97	5	141.19	139-1-3/4"
2	3.56	1132	8.50	4.38	3.63	2.25	2.25	Bulk	245.19	139-2"
2-1/4	4.12	1936	9.56	5.03	4.03	2.50	2.53	Bulk	409.19	139-2-1/4"
2-1/2	4.5	2352	10.5	5.50	4.50	2.75	2.81	Bulk	494.86	139-2-1/2"

Stamping of swaged steel sleeves for identification is allowed without concern of fractures if the following directions are followed:

1. Use round corner stamps.
2. The maximum depth of stamps is not over 0.015 inch (0.4mm).
3. The area for stamping should be on the side of the sleeve in the plane of the sling eye, and no less than 0.25 inch (6.35mm) from either end of sleeve.

SLEEVES (FERRULES) SIZE NUMBER TABLE A.2

Rope Diameter			Ferrule Size Number Table A.2			
			Case 1	Case 2	Case 3	Case 4
Nominal	Measured		single layer round strand ropes with FC and cable laid ropes C ≥ 0,283	single layer round strand ropes with IWRC and rotation-resistant round strand ropes C < 0,487	single layer round strand ropes with IWRC, rotation-resistant ropes and parallel-closed ropes 0,487 < C < 0,613	spiral strands 2 ferrules C ≥ 0,613
Dia.	from:	to:				
(mm)	(mm)	(mm)				
2.5	2.5	2.7	2.5	3	-	-
3	2.8	3.2	3	3.5	-	-
3.5	3.3	3.7	3.5	4	-	-
4	3.8	4.3	4	4.5	-	5
4.5	4.4	4.8	4.5	5	-	6
5	4.9	5.4	5	6	-	6.5
6	5.5	5.9	6	6.5	-	7
	6	6.4			7	
6.5	6.5	6.9	6.5	7	8	8
7	7	7.4	7	8	9	9
8	7.5	7.9	8	9	9	10
	8	8.4			10	
9	8.5	8.8	9	10	10	11
	9	9.5			11	
10	9.6	9.9	10	11	11	12
	10	10.5			12	
11	10.6	10.9	11	12	12	13
	11	11.6			13	
12	11.7	11.9	12	13	13	14
	12	12.6			14	
13	12.7	12.9	13	14	14	16
	13	13.7			16	
14	13.8	13.9	14	16	16	18
	14	14.7			18	
16	14.8	15.9	16	18	18	20
	16	16.8			20	
18	16.9	17.9	18	20	20	22
	18	18.9			22	
20	19	19.9	20	22	22	24
	20	21			24	
22	21.1	21.9	22	24	24	26
	22	23.1			26	
24	23.2	23.9	24	26	26	28
	24	25.2			28	
26	25.3	25.9	26	28	28	30
	26	27.3			30	
28	27.4	27.9	28	30	30	32
	28	29.4			32	
30	29.5	29.9	30	32	32	34
	30	31.5			34	
32	31.6	31.9	32	34	34	36
	32	33.6			36	
34	33.7	33.9	34	36	36	38
	34	35.7			38	
36	35.8	35.9	36	38	38	40
	36	37.8			40	
38	37.9	37.9	38	40	40	44
	38	39.9			44	
40	40	42	40	44	48	48
	44	43.9			48	
44	44	46.2	44	48	52	52
	46.3	47.9			52	
48	48	50.4	48	52	56	56
	50.5	51.9			56	
52	52	54.6	52	56	60	60
	54.7	55.9			-	
56	56	58.8	56	60	-	-
	58.9	59.9			-	
60	60	63	60	-	-	-
	-	-			-	

WIRE ROPE END TERMINATIONS

SLEEVE (FERRULE) - ALUMINIUM

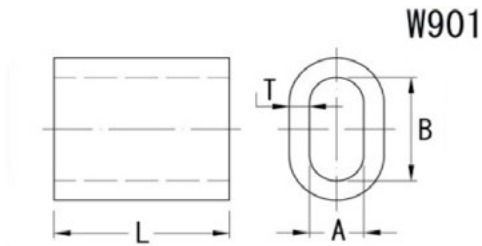

Ferrule Code	Dimensions (mm)				Weight (lb) / 100 pcs	Price / ea.	Part Number
	A	B	T	L			
11	12.1	24.2	4.5	39	7.89	2.00	176-W901-011
12	13.2	26.4	4.9	42	10.09	2.25	176-W901-012
13	14.2	28.4	5.4	46	13.16	3.07	176-W901-013
14	15.3	30.6	5.8	49	16.20	3.50	176-W901-014
16	17.5	35	6.7	56	24.46	5.62	176-W901-016
18	19.6	39.2	7.6	63	34.38	7.35	176-W901-018
20	21.7	43.4	8.4	70	47.83	9.07	176-W901-020
22	24.3	48.6	9.2	77	64.36	11.83	176-W901-022
24	26.4	52.8	10	84	82.87	16.20	176-W901-024
26	28.5	57	10.9	91	106.01	19.56	176-W901-026
28	31	62	11.7	98	132.90	24.22	176-W901-028
30	33.1	66.2	12.5	105	162.88	29.24	176-W901-030
32	35.2	70.4	13.4	112	197.70	37.81	176-W901-032
34	37.8	75.6	14.2	119	237.44	47.62	176-W901-034
36	39.8	79.6	15	126	281.01	56.90	176-W901-036

All WIROP® aluminium ferrules are made of seamless aluminium. Random samples have been passed with 75,000 cycles fatigue test, and strictly follow the material composition and mechanical property requirements of the EN 13411-3 (DIN 3093) standard.

Dies for EN 13411-3 Form A (DIN 3093) Aluminium Ferrules Swaging are needed in order to swage these aluminium ferrules.

Swaging is finished in one step. Turn the ferrule 90 degrees and swage again is NOT recommended. WIROP® reserves the right to change specifications.

Please refer to the Ferrule Size Selection Chart on the previous page to find the correct size ferrule for the type of wire being used - Table A.2, Ferrule Size Numbers from the BS EN 13411-3:2004 standard.

The efficiency of the termination for Aluminum Ferrule splicing is 90% of the wire rope breaking strength with proper splicing technique and standard-length ferrule.

SLEEVE (FERRULE) - ALUMINIUM DUPLEX

Generally used with galvanized wire

Cable Size (in)	Weight / 100 pcs (lb)	Dimensions (in)			O.D After Swage (in)	Price / ea.	Part Number
		Length	Depth	Width			
1/16	0.10	3/8	11/64	1/4	0.187	0.17	6-1/16ALDUP
3/32	0.30	1/2	9/32	13/32	0.281	0.20	6-3/32ALDUP
1/8	0.66	5/8	11/32	1/2	0.312	0.27	6-1/8ALDUP
5/32	0.88	11/16	3/8	9/16	0.375	0.28	6-5/32ALDUP
3/16	1.6	1	7/16	21/32	0.437	0.43	6-3/16ALDUP
1/4	2.8	1-1/8	17/32	13/16	0.563	0.68	6-1/4ALDUP
5/16	4.6	1-1/4	11/16	1-1/32	0.687	1.12	6-5/16ALDUP
3/8	5.9	1-7/16	3/4	1-5/32	0.812	1.38	6-3/8ALDUP
7/16	12	1-11/16	15/16	1-7/16	1.000	3.11	6-7/16ALDUP
1/2	17	2	1-1/16	1-5/8	1.120	4.92	6-1/2ALDUP



SLEEVE (FERRULE) - ALUMINIUM STOP

Generally used with galvanized wire

Cable Size (in)	Weight / 100 pcs (lb)	Outside Dia. (in)	Inside Dia. (in)	O.D After Swage (in)	Price / ea.	Part Number
1/16	0.06	1/4	3/32	0.187	0.21	6-AST116
3/32	0.25	11/32	1/8	0.245	0.21	6-AST332
1/8	0.24	11/32	5/32	0.245	0.21	6-AST18
5/32	0.38	7/16	3/16	0.325	0.26	6-AST532
3/16	0.35	7/16	7/32	0.325	0.26	6-AST316
1/4	2.06	11/16	9/32	0.508	0.53	6-AST14
5/16	1.74	11/16	3/8	0.508	0.69	6-AST516



SLEEVE (FERRULE) - COPPER OVAL

Generally used with stainless steel wire

Cable Size (in)	Weight / 100 pcs (lb)	Dimensions (in)			O.D After Swage (in)	Price / ea.	Part Number
		Length	Depth	Width			
1/16	0.3	25/64	11/64	1/4	0.190	0.32	91-CSL116
3/32	0.65	29/64	15/64	3/8	0.265	0.79	91-CSL332
1/8	1.6	9/16	21/64	1/2	0.353	1.18	91-CSL18
5/32	2.3	5/8	3/8	19/32	0.390	1.75	91-CSL532
3/16	5.1	7/8	7/16	43/64	0.475	3.51	91-CSL316
1/4	7.5	1-1/8	13/16	1/2	0.585	4.87	91-CSL14
5/16	11.8	1-1/8	21/32	1-1/64	0.730	8.88	91-CSL516
3/8	17	1-1/2	23/32	1-1/8	0.795	11.82	91-CSL38



SLEEVE (FERRULE) - COPPER STOP

Generally used with stainless steel wire

Cable Size (in)	Weight / 100 pcs (lb)	Outside Diameter (in)	Inside Diameter (in)	O.D After Swage (in)	Price / ea.	Part Number
1/16	0.20	13/64	5/64	0.182	0.52	91-CST116
3/32	0.80	21/64	7/64	0.261	1.33	91-CST332
1/8	0.80	21/64	5/32	0.261	1.10	91-CST18
5/32	1.3	27/64	3/16	0.350	2.02	91-CST532
3/16	1.2	27/64	7/32	0.350	1.81	91-CST316
1/4	6	21/32	9/32	0.600	4.74	91-CST14
5/16	9	21/32	5/16	0.600	4.31	91-CST516



SLEEVE (FERRULE) - STAINLESS STEEL DUPLEX



Material: 304 Stainless Steel

Cable Size (in)	Weight / each (lb)	Before Swage (in)			After Swage (in)		Price / ea.	Part Number
		Length	Width	Height	Length	Dia.		
1/4	0.03	7/8	9/16	3/4	1	0.53	11.73	15-1/4SSSLEEVE
5/16	0.18	1-19/32	25/32	1-1/8	1-9/16	0.76	21.00	15-5/16SSSLEEVE
3/8	0.14	1-23/32	13/16	1-1/8	1-7/8	0.76	29.89	15-3/8SSSLEEVE
7/16	0.35	2-1/32	1-1/32	1-7/16	1-15/16	1.01	49.18	15-7/16SSSLEEVE
1/2	0.31	2	1	1-7/16	2-1/4	1.01	54.96	15-1/2SSSLEEVE
9/16	0.6	2-1/4	1-3/16	1-3/4	2-1/2	1.27	74.56	15-9/16SSSLEEVE
5/8	0.6	2-23/32	1-1/4	1-13/16	2-5/8	1.27	76.60	15-5/8SSSLEEVE
3/4	1	3	1-7/16	2-1/8	3-3/8	1.53	112.07	15-3/4SSSLEEVE

SLEEVE (FERRULE) - DUPLEX OVAL

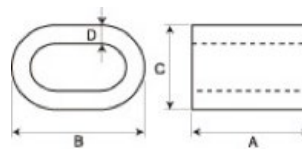

Rope Size (in)	Weight / 100 pcs (lb)	Dimensions (in)				After Swage Dia. (in)	Price / ea.	Part Number
		A	B	C	D			
5/16	17	1.25	1.08	0.81	0.19	0.77	19.32	33-903-08
3/8	13	1.25	1.12	0.81	0.14	0.77	19.16	33-903-10
7/16	31	1.63	1.41	1.02	0.19	1.03	23.49	33-903-11
1/2	27	1.63	1.44	1.02	0.16	1.03	23.55	33-903-13
9/16	63	2.25	1.72	1.23	0.23	1.29	25.76	33-903-14
5/8	54	2.25	1.84	1.28	0.20	1.29	25.60	33-903-16
3/4	90	2.63	2.16	1.52	0.23	1.55	35.79	33-903-19
7/8	126	2.88	2.50	1.75	0.27	1.80	51.52	33-903-22
1	187	3.06	2.84	2.00	0.33	2.05	68.11	33-903-25
1-1/4	384	4.06	3.50	2.50	0.38	2.56	198.14	33-903-32

SLEEVE (FERRULE) - BUTTON STOP



Cable Size (in)	Weight / 100 pcs (lb)	Before Swage Dimension (in)			After Swage Dimension (in)		Price / ea.	Part Number
		O.D.	Length	Hole Dia.	Max Dia.	Length		
1/4	8	0.63	1.06	0.30	0.58	1.41	5.17	16-1/4"BUTTON
5/16	16	0.88	1.13	0.36	0.77	1.33	5.70	16-5/16"BUTTON
3/8	15	0.88	1.48	0.42	0.77	1.69	7.12	16-3/8"BUTTON
7/16	30	1.13	1.63	0.48	1.03	1.94	8.91	16-7/16"BUTTON
1/2	50	1.31	1.89	0.55	1.16	2.17	11.36	16-1/2"BUTTON
5/8	100	1.56	2.42	0.67	1.42	2.89	16.58	16-5/8"BUTTON
3/4	131	1.69	2.73	0.79	1.55	3.25	21.19	16-3/4"BUTTON
7/8	220	2.00	3.27	0.94	1.80	3.86	36.38	16-7/8"BUTTON
1	310	2.25	3.67	1.06	2.05	4.36	46.65	16-1"BUTTON
1-1/8	450	2.56	4.05	1.19	2.30	4.81	79.41	16-1-1/8"BUTTON
1-1/4	650	2.81	4.58	1.33	2.56	5.42	111.08	16-1-1/4"BUTTON

MARLIN SPIKE



Size (in)	Price / ea.	Part Number
6	21.45	99-MS06
8	31.78	99-MS08
10	36.70	99-MS10
12	46.54	99-MS12
14	56.98	99-MS14
16	95.39	99-MS16
18	99.13	99-MS18
20	117.65	99-MS20

THIMBLE - HEAVY DUTY

- Material: Steel.
- Standard: FF-T-276C
- Finish: Hot Dip Galvanized

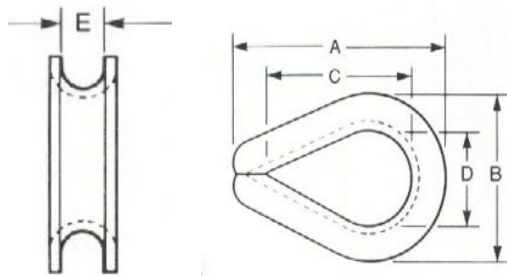

Rope Dia. (in)	Wt. / 100 pcs. (lb)	Dimensions (in)						Qty. / Box	Price / ea.	Part Number
		A	B	C	D	E	Thickness			
1/4	6.5	2.19	1.50	1.63	0.88	0.28	0.41	1000	0.51	6-1/4GT
5/16	11.8	2.50	1.81	1.88	1.06	0.34	0.50	500	1.01	6-5/16GT
3/8	21.6	2.88	2.13	2.13	1.13	0.41	0.63	250	1.86	6-3/8GT
7/16	34.7	3.25	2.38	2.38	1.25	0.47	0.72	150	2.20	6-7/16GT
1/2	51.0	3.63	2.75	2.75	1.50	0.53	0.81	100	3.21	6-1/2GT
9/16	51.0	3.63	2.69	2.75	1.50	0.59	0.88	100	4.03	6-9/16GT
5/8	75.7	4.25	3.13	3.25	1.75	0.66	0.97	80	4.54	6-5/8GT
3/4	158.1	5.00	3.81	3.75	2.00	0.78	1.22	50	8.39	6-3/4GT
7/8	177.8	5.50	4.25	4.25	2.25	0.94	1.38	30	12.11	6-7/8GT
1	313.9	6.13	4.94	4.50	2.50	1.06	1.56	20	15.64	6-1GT
1 1/8 - 1 1/4	400.0	7.00	5.88	5.13	2.88	1.31	1.81	15	21.64	6-11/8-11/4GT
1 1/4 - 1 3/8	811.0	9.00	6.81	6.25	3.50	1.44	2.19	6	50.04	6-11/4-13/8GT
1 3/8 - 1 1/2	1295	9.06	7.13	6.50	3.50	1.56	2.56	5	71.49	6-1-1/2GT
1 3/4	1775	12.19	8.50	9.00	4.50	1.84	2.84	4	101.59	6-1-3/4GT
2	2775	15.13	10.38	12.00	6.00	2.09	3.09	2	151.91	6-2GT
2 1/4	3950	17.13	11.88	14.00	7.00	2.38	3.63	1	324.33	6-2-1/4GT
2 1/2	6350	18.50	12.75	15.00	7.00	3.00	4.50	1	580.53	6-2-1/2GT
3	11 000	21.50	13.00	18.00	8.00	3.50	5.25	1	788.76	6-3GT

THIMBLE - LIGHT DUTY

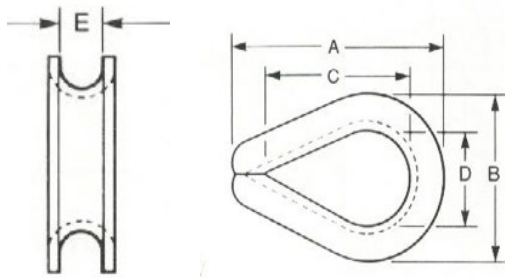

Rope Dia. (in)	Wt. / 100 pcs. (lb)	Dimensions (in)					Price / ea.	Part Number
		A	B	C	D	E		
1/8	3.50	1.94	1.06	1.31	0.69	0.16	0.38	6-1/8"GLDT
3/16	3.50	1.94	1.06	1.31	0.69	0.22	0.38	6-3/16"GLDT
1/4	3.50	1.94	1.06	1.31	0.69	0.28	0.38	6-1/4"GLDT
5/16	4.00	2.13	1.25	1.50	0.81	0.34	0.44	6-5/16"GLDT
3/8	6.70	2.38	1.47	1.63	0.94	0.41	0.57	6-3/8"GLDT
1/2	12.5	2.75	1.75	1.88	1.13	0.53	1.03	6-1/2"GLDT
5/8	34.50	3.50	2.38	2.25	1.38	0.66	2.55	6-5/8"GLDT
3/4	47.10	3.75	2.69	2.50	1.63	0.78	4.01	6-3/4"GLDT
7/8	84.60	5.00	3.19	3.50	1.88	0.94	6.17	6-7/8GLDT
1	97.50	5.69	3.75	4.25	2.50	1.06	7.41	6-1"GLDT

THIMBLE - HEAVY DUTY

- Material: 304 Stainless Steel.
- Standard: FF-T-276C
- Finish: Stainless Steel

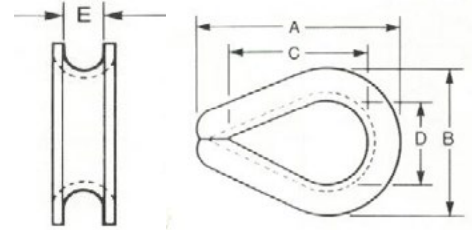

Rope Dia. (in)	Wt. / 100 pcs. (lb)	Dimensions (in)					Thickness	Price / ea.	Part Number
		A	B	C	D	E			
1/4	6.5	2.19	1.43	1.65	0.88	0.28	0.41	2.71	6-1/4"SSHDTH
5/16	11.8	2.75	1.88	2.00	1.06	0.34	0.50	3.91	6-5/16"SSHDTH
3/8	21.6	2.88	2.00	2.13	1.13	0.41	0.63	7.51	6-3/8"SSHDTH
1/2	51.0	3.63	2.75	2.75	1.50	0.53	0.81	16.66	6-1/2"SSHDTH
5/8	75.7	4.25	3.25	3.13	1.75	0.66	0.97	21.64	6-5/8"SSHDTH
3/4	158.1	5.00	3.75	3.81	2.00	0.78	1.22	47.32	6-3/4"SSHDTH

THIMBLE - LIGHT DUTY

- Material: 304 Stainless Steel.
- Standard: FF-T-276C
- Finish: Stainless Steel

Size (in)	Price / ea.	Part Number
1/8	1.58	6-1/8"SSLDTH
3/16	1.84	6-3/16"SSLDTH



THIMBLE - TUBE

- Material: Steel.
- Standard: FF-T-276C
- Finish: Painted Yellow



Size (mm)	Type	Price / ea.	Part Number
12	215	19.24	6-TT1/2
14	217	22.75	6-TT9/16
16	219	32.17	6-TT5/8
18	222	41.53	6-TT3/4
22	225	59.16	6-TT7/8
24	228	75.64	6-TT15/16
26	230	79.08	6-TT1
32	235	107.60	6-TT1-1/4

SOLID THIMBLE - DIN 3091

- Material: Cast Iron
- DIN 3091
- Finish: Hot Dip Galvanized

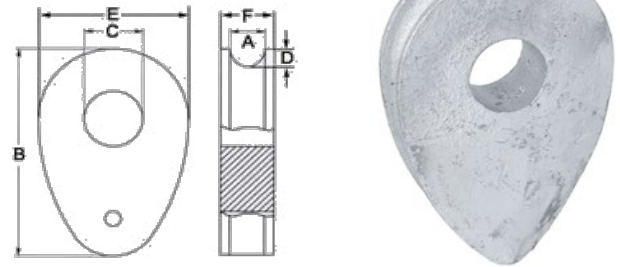

Size	Dimensions (mm)						Weight / ea. kgs	Price / ea.	Part Number
	A	B	C	D	E	F			
10	11	70	18	6	50	17.5	0.24	20.33	6-10MMST
12	13	84	21	7.5	60	20	0.39	26.50	6-12MMST
14	16	98	25	9	70	23.5	0.61	41.39	6-14MMST
16	18	110	28	10.5	80	26	0.84	57.05	6-16MMST
18	20	130	31	12	90	28.5	1.21	61.61	6-18MMST
20	22	140	35	13.5	100	31	1.55	78.57	6-20MMST
22	24	150	38	15	110	33.5	1.90	99.77	6-22MMST
24	26	170	41	16.5	120	36	2.75	136.87	6-24MMST
26	29	180	44	18	130	39.5	3.16	166.59	6-26MMST
28	31	200	47	20	140	42	3.29	180.97	6-28MMST
32	35	220	53	23	160	47	6.05	308.75	6-32MMST
36	40	250	59	26	180	53	8.60	435.39	6-36MMST

THIMBLE - SYNTHETIC ROPE

- Material: Steel
- Standard: FF-T-276C
- Finish: Hot Dip Galvanized

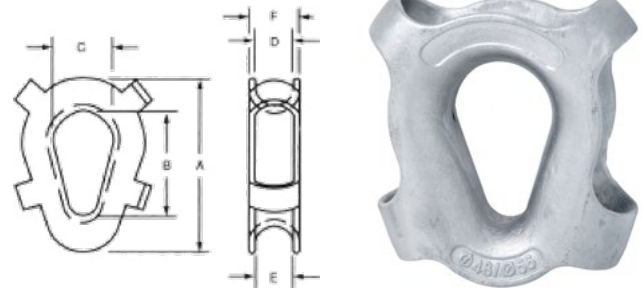

Size (in)	Rope Dia. (mm)	Wt. (lb)	Dimensions (mm)						Price / ea.	Part Number
			A	B	C	D	E	F		
1-1/4 - 1-5/8	32 - 40	6.6	196	127	85	50	50	60	284.46	6-1-1/4-1-5/8SRT
2 - 2-1/4	48 - 56	15	247	149	92	72	72	89	515.36	6-2-2-1/4SRT
2-5/8	64	19.4	276	159	102	75	75	79	626.98	6-2-5/8SRT
3	72	30.2	320	195	120	87	87	105	812.23	6-3SRT
3-1/4	80 - 86	41.8	360	220	128	101	101	114	1213.67	6-3-1/4SRT

CHOKER BUTTON



Size (in)	Price / ea.	Part Number
7/16	4.92	31-7/16"CB
1/2	4.92	31-1/2"CB

HOOK - MICRO MIDGET CHOKER

- New improved manufacturing process
- Material: 35CMRO Alloy Steel Heat treated



Price / ea.	Part Number
20.88	90-CHCM

GO-NO-GO GAGUES - FOR FLEMISH EYE STEEL SLEEVES (FERRULES)

For measuring after swage dimensions of Flemish eye steel sleeves to ensure the sleeve is swaged to proper dimensions for reasons such as worn dies and / or incorrect swaging procedures.



For Sleeve Sizes	Price / ea.	Part Number
1/4" ~ 1-1/4"	185.70	176-1/4-1-1/4NGG
1-3/8" ~ 1-1/2"	185.70	176-1-3/8-1-1/2NGG
1-3/4" ~ 2"	185.70	176-1-3/4-2NGG
2-1/4" ~ 2-1/2"	185.70	176-2-1/4-2-1/2NGG

CABLE JOINER - SELF-LOCKING

WLL (lb)	Wire Diameter (in)	Wire Construction	Material	Price	Part Number
10 - 75	1/16	7 x 7	Galvanised Steel	10.01	27-KL75
0 - 75	1/16	7 x 7	Galvanised Steel	Pricing on Request	27-KL100
25 - 150	3/32	7 x 7	Galvanised Steel		27-KL150
25 - 150	3/32	7 x 7	Galvanised Steel		27-KL200
25 - 250	1/8	7 x 7	Galvanised Steel		27-KL200
25 - 250	1/8	7 x 7	Galvanised Steel		27-KL200
50 - 640	3/16	7 x 19	Galvanised Steel		27-KL200
50 - 1000	1/4	7 x 19	Galvanised Steel		27-KL600



Assembly Instructions:

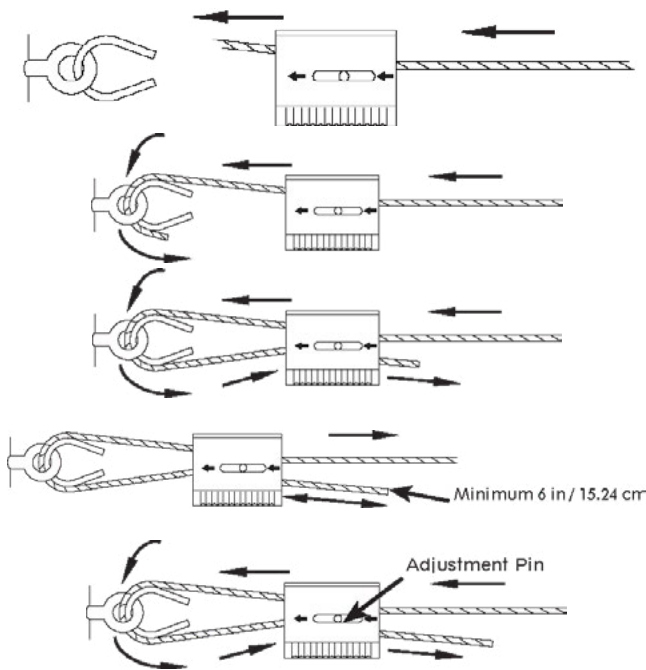

Pull adjustment pin back and pass wire through joiner. Failure to pull adjustment pin first may cause damage to serrated teeth and reduce holding capacity.

Lop wire through anchor.

Pull adjustment pin back and pass wire back through joiner. Push through at least 6" of wire rope.

Always confirm engagement of joiner on wire before applying load by pushing the adjustment pin in the opposite direction of the arrows on the cable lock and then pulling the cable also in the opposite direction of the arrows on the cable lock.

To adjust, take the load off and pull the tail slightly to disengage teeth, then release using adjustment pin.

Warning Instructions:

- To ensure hanging system integrity and safety, use only properly sized wire rope.
- Always pull adjustment pin back before passing wire rope through rise cable lock. Failure to pull adjustment pin first may cause damage to serrated teeth and reduce holding capacity.
- Always confirm engagement of joiner on wire before applying load by pushing the adjustment pin in the opposite direction of the arrows on the cable lock and then pulling the cable also in the opposite direction of the arrows on the cable lock.

- Do not use for loads outside the stated range of the product.
- Do not exceed the safe working range of the product.
- Do not use on coated wire rope, paint, lubricant, or other coating.
- Do not use for lofting or dynamic loads.
- Keep the product clean and free from dirt.
- Remove damaged cable end prior to inserting into the joiner.
- Do not use in chlorinated atmospheres.
- For use on static load applications only.

CLIP - WIRE ROPE, MALLEABLE

- To be used for light Duty, NON CRITICAL applications only.
- Typical uses include: guard line and fencing.
- Material: Malleable Steel
- Standard: FF-C-450, Type 1 Class 2.
- Finish: Electro-Galvanized
- Identification: Size

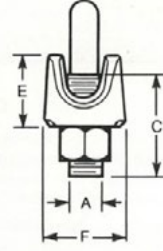
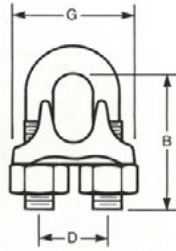

Rope Size (in)	Weight / 100 pcs. (lb)	Dimensions (in)							Price / ea.	Part Number
		A	B	C	D	E	F	G		
1/8	4	0.18	0.81	0.50	0.50	0.50	0.56	0.94	0.28	6-1/8"MC
3/16	6.3	0.25	0.94	0.56	0.56	0.56	0.63	1.06	0.46	6-3/16"MC
1/4	13	0.31	1.19	0.75	0.75	0.69	0.75	1.31	0.69	6-1/4"MC
5/16	15	0.31	1.31	0.84	0.75	0.75	0.75	1.44	0.76	6-5/16"MC
3/8	21	0.38	1.63	1.00	0.88	0.84	0.88	1.63	1.11	6-3/8"MC
1/2	37	0.44	2.00	1.19	1.06	1.00	1.06	1.88	1.75	6-1/2"MC
5/8	59	0.50	2.31	1.38	1.25	1.25	1.28	2.09	2.62	6-5/8"MC
3/4	84	0.56	2.56	1.56	1.31	1.44	1.56	2.38	3.73	6-3/4"MC
7/8	125	0.63	3.06	1.81	1.63	1.75	1.81	2.88	5.65	6-7/8"MC
1	166	0.63	3.44	2.00	1.88	2.06	2.00	3.00	6.71	6-1"MC

CLIP - WIRE ROPE, STAINLESS

- Material: 304 Stainless Steel
- Standard: FF-C-450
- Finish: Stainless Steel
- Identification: Size

Size (in)	Price / ea.	Part Number
1/8	2.58	6-1/8"304SS
3/16	3.21	6-3/16"304SS
1/4	4.73	6-1/4"304SS
5/16	5.87	6-5/16"304SS
3/8	9.47	6-3/8"304SS
1/2	15.14	6-1/2"304SS
5/8	21.26	6-5/8"304SS



CLIP - WIRE ROPE, FORGED

- Only genuine 'OCEAN' clips have yellow U-Bolt for instant recognition.
- Material: Forged Steel
- Standard: EN 13411-5, FF-C-450: Type 1 Class 1, ASME B30.26
- Finish: Clip: Galvanized, U-Bolt: Powder Coated Yellow.
- Identification: Trademark, Size/WLL, Batch Code

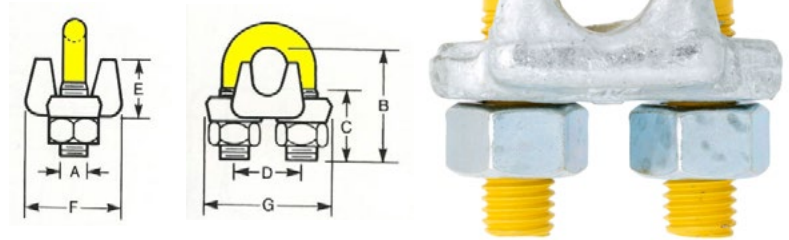

Rope Size (in)	Weight / 100 pcs. (lb)	Dimensions (in)						Use			Qty. / Box	Price / ea.	Part Number
		A	B	D	E	F	G	*Min #	Torque (lbf * ft)	Min. rope turn back (in)			
1/8	6	0.22	0.72	0.47	0.41	0.81	0.94	2	4.5	3 1/4	1000	1.17	6-1/8"FC
3/16	10	0.25	0.97	0.59	0.50	0.94	1.16	2	7.5	3 3/4	500	1.64	6-3/16"FC
1/4	20	0.31	1.03	0.75	0.66	1.19	1.44	2	15	4 3/4	250	1.69	6-1/4"FC
5/16	30	0.38	1.38	0.88	0.72	1.31	1.69	2	30	5 1/4	150	2.05	6-5/16"FC
3/8	47	0.44	1.50	1.00	0.91	1.63	1.94	2	45	6 1/2	100	2.97	6-3/8"FC
1/2	80	0.50	1.88	1.19	1.13	1.91	2.28	3	65	11 1/2	75	4.73	6-1/2"FC
9/16	104	0.56	2.25	1.31	1.22	2.06	2.50	3	95	12	50	6.41	6-9/16"FC
5/8	106	0.56	2.38	1.31	1.34	2.06	2.50	3	95	12	50	7.13	6-5/8"FC
3/4	150	0.62	2.75	1.50	1.41	2.25	2.84	4	130	18	35	10.71	6-3/4"FC
7/8	212	0.75	3.12	1.75	1.59	2.44	3.16	4	225	19	25	17.10	6-7/8"FC
1	260	0.75	3.50	1.88	1.78	2.63	3.47	5	225	26	20	18.69	6-1"FC
1 1/8	290	0.75	3.88	2.00	1.91	2.81	3.59	6	225	34	15	21.35	6-1-1/8"FC
1 1/4	430	0.88	4.25	2.31	2.19	3.13	4.13	7	360	44	12	30.10	6-1-1/4"FC
1 1/2	540	0.88	4.94	2.59	2.44	3.41	4.44	8	360	54	9	33.20	6-1-1/2"FC
1 3/4	925	1.13	5.75	3.06	2.94	3.81	5.28	8	590	61	6	130.14	6-1-3/4"FC
2	1300	1.25	6.44	3.38	3.28	4.44	5.88	8	750	71	4	176.17	6-2"FC
2 1/4	1540	1.25	7.13	3.86	3.19	4.49	6.38	8	750	73	3	187.74	6-2-1/4"FC
2 1/2	1980	1.25	7.68	4.13	3.70	4.06	6.67	9	750	84	Bulk	208.80	6-2-1/2"FC
2 3/4	2200	1.25	8.31	4.37	4.88	5.00	6.89	10	750	100	Bulk	POR	116-2-3/4"FC
3	3080	1.50	9.77	4.76	4.69	5.87	7.64	10	1200	106	Bulk	488.28	6-3"FC
3 1/2	3960	1.50	10.75	5.51	5.98	6.18	8.39	12	1200	149	Bulk	POR	116-3-1/2"FC

WIRE ROPE END TERMINATIONS

CLIPS WIRE ROPE 'OCEAN' - WARNINGS AND APPLICATION INSTRUCTIONS

Efficiency ratings for wire rope end terminations are based on the catalog strength of standard EIPS wire rope. The efficiency rating of a properly prepared loop or thimble eye termination for clip sizes 1/8" through 7/8" is 80%, and for 1" through 3-1/2" is 90%.

Based on RRL or RLL wire rope class 6x19 or 6x37, FC or IWRC, EEIPS. If Seale construction or similar large outer wire type construction in the 6x19 class is to be used add one extra clip. If a pulley or sheave is to be used, add one extra clip.

For elevator, personal hoist, and scaffold applications refer to ANSI A17.1 and ANSI A10.4. These standards do not recommend U-Bolt wire rope terminations.

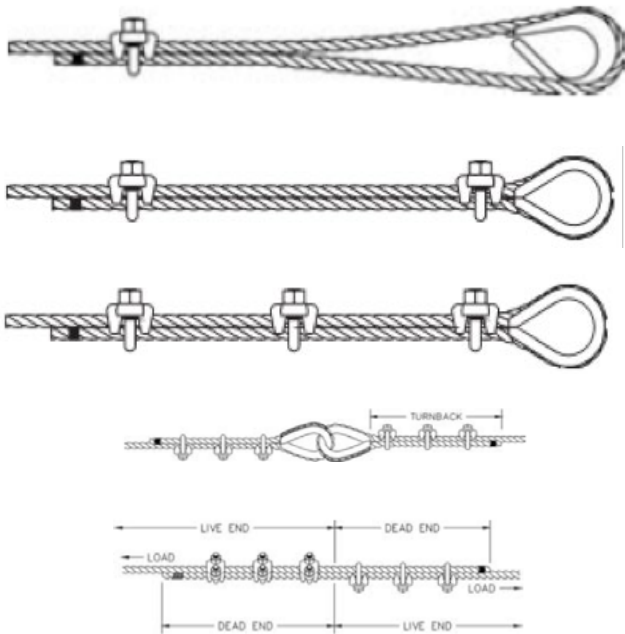

Turn back specified amount of rope from thimble or loop. Apply first clip one base width from dead end of rope, live end rests in saddle. Use torque wrench to tighten evenly alternating from one nut to the other until achieving recommended torque.

Apply the second clip as near the loop or thimble as possible, if more than two clips are required, tighten firmly but do not torque, go to the next step. If only two clips are required tighten evenly while alternating nuts until reaching the recommended torque.

Space additional clips evenly between the first two clips, take up the rope slack, and tighten evenly on each U-Bolt including the clip closest to the eye, alternating nuts until reaching recommended torque.

The recommended method of joining two wire ropes together with U-Bolt clips is to use inter locking turn back eyes with thimbles while using the recommended number of clips on each eye.

An alternate method is to use twice the number of clips as used by a turn back termination. The rope ends are placed parallel to each other overlapping by twice the turn back amount recommended, while using the minimum amount of clips on each dead end. Tighten evenly on each U-Bolt alternating nuts until reaching recommended torque.

**** Remember apply the first load to test the assembly as mentioned in the warnings ****

If a greater number of clips are used than shown in the chart, the amount of turn back should be increased proportionately.

- FAILURE TO READ, UNDERSTAND AND FOLLOW THESE INSTRUCTIONS MAY CAUSE DEATH OR SERIOUS INJURY
- READ AND UNDERSTAND THESE INSTRUCTIONS BEFORE USING CLIPS
- MATCH THE SAME SIZE CLIP TO THE SAME SIZE WIRE ROPE
- PREPARE WIRE ROPE AND TERMINATION ONLY AS INSTRUCTED
- DO NOT USE WITH PLASTIC COATED WIRE ROPE
- APPLY FIRST LOAD TO TEST THE ASSEMBLY. THIS LOAD SHOULD BE OF EQUAL OR GREATER WEIGHT THAN LOADS EXPECTED IN USE. NEXT, CHECK AND RETIGHTEN NUTS TO RECOMMENDED TORQUE

SOCKET - SPELTER, OPEN, FORGED, OCEAN

- Spelter sockets are forged from special bar quality carbon steel with the very finest in hardness controls.
- Spelter sockets properly applied have an efficiency rating of 100% based on catalog strength of wire rope.
- Socket size range 1/4" through 3/4" using one groove, 7/8" trough 1-1/2" uses 2 grooves. Ocean Open Spelter Sockets meet the performance requirements on Federal Specification RR-S-550E, Type A.

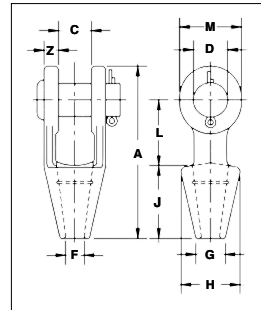

Wire Size (in)	Structural Strand Dia. (in)	Dimensions (in)											Wt./ea.(lb)	Price / ea.	Part Number	
		L	W	D1	d	D	T	H	K	A	C	F				G
5/16 - 3/8	--	4.84	0.83	0.79	0.51	0.83	1.73	2.25	1.77	1.50	0.44	1.3	83.15	3-3/8OSP		
7/16 - 1/2	--	5.62	1.00	0.98	0.56	0.98	1.96	2.48	2.13	1.91	0.50	2.3	109.81	3-1/2OSP		
9/16 - 5/8	1/2	6.77	1.26	1.19	0.70	1.14	2.25	3.00	2.52	2.28	0.55	3.7	127.32	3-5/8OSP		
3/4	9/16 - 5/8	7.96	1.50	1.38	0.81	1.26	2.64	3.62	3.00	2.64	0.62	5.8	189.75	3-3/4OSP		
7/8	11/16 - 3/4	9.25	1.77	1.63	0.94	1.50	3.35	4.02	3.50	3.17	0.80	10.4	294.12	3-7/8OSP		
1	13/16 - 7/8	10.55	2.05	2.00	1.14	1.75	3.75	4.48	4.02	3.78	0.91	16.3	505.05	3-1OSP		
1-1/8	15/16-1	11.81	2.25	2.25	1.25	2.00	4.13	5.00	4.60	4.13	1.00	22.0	769.78	3-1-1/8OSP		
1-1/4-1-3/8	1-1/16-1/8	13.19	2.50	2.50	1.51	2.24	4.76	5.51	5.00	4.76	1.13	32.8	866.00	3-1-1/4OSP		
1-1/2	1-3/16-1-1/4	15.12	3.00	2.75	1.63	2.75	5.25	5.98	5.98	5.37	1.19	45.9	1268.92	3-1-1/2OSP		

SOCKET - SPELTER, CLOSED, FORGED, OCEAN

- Spelter sockets are forged from special bar quality carbon steel with the very finest in hardness controls.
- Spelter sockets properly applied have an efficiency rating of 100% based on catalog strength of wire rope.
- Socket size range 1/4" through 3/4" using one groove, 7/8" trough 1-1/2" uses 2 grooves. Ocean Closed Spelter Sockets meet the performance requirements on Federal Specification RR-S-550E, Type A.

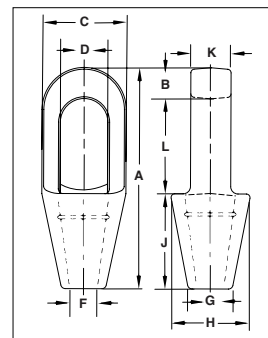

Wire Size (in)	Structural Strand Dia. (in)	Dimensions (in)											Wt./ea.(lb)	Price / ea.	Part Number
		L	B	A	D1	d	D	T	H	W	K	F			
5/16 - 3/8	--	4.88	0.62	1.69	0.98	0.50	0.83	1.70	2.25	0.71	2.00	0.8	66.49	3-3/8CSP	
7/16 - 1/2	--	5.43	0.71	2.00	1.19	0.55	0.98	1.96	2.52	0.87	2.25	1.5	90.01	3-1/2CSP	
9/16 - 5/8	1/2	6.31	0.83	2.63	1.41	0.71	1.12	2.50	3.00	0.98	2.52	2.6	111.47	3-5/8CSP	
3/4	9/16 - 5/8	7.58	1.06	3.00	1.61	0.81	1.26	2.75	3.50	1.26	3.00	4.3	156.04	3-3/4CSP	
7/8	11/16 - 3/4	8.75	1.26	3.63	1.89	0.94	1.50	3.46	3.98	1.50	3.50	7.9	240.24	3-7/8CSP	
1	13/16 - 7/8	9.88	1.38	4.13	2.28	1.14	1.77	3.78	4.50	1.77	4.02	10.5	344.91	3-1CSP	
1-1/8	15/16-1	11.14	1.56	4.53	2.52	1.25	2.00	4.13	5.00	2.00	4.48	15.2	426.98	3-1-1/8CSP	
1-1/4-1-3/8	1-1/16-1/8	12.13	1.63	5.04	2.80	1.52	2.25	4.76	5.51	2.25	4.90	22.7	634.46	3-1-1/4CSP	
1-1/2	1-3/16-1-1/4	13.94	1.94	5.43	3.19	1.63	2.77	5.25	5.98	2.52	5.98	30.9	891.91	3-1-1/2CSP	

SOCKET - SPELTER, OPEN, GN®

Made in Holland

Cast material, 5:1 safety, 3.1B certificates and material certificate, galvanized finish, c/w cotter pin. Rated in Metric Ton(s)

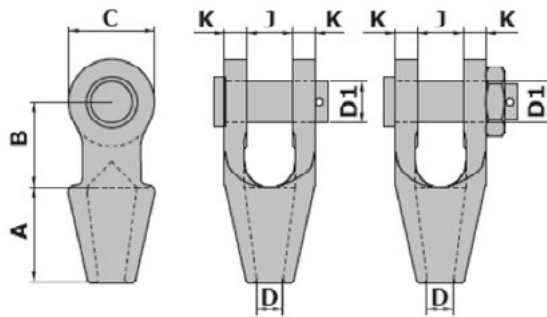

Galvanized Finish

Wire Size (in)	MBL (t)	Dimensions (mm)							Wt./ea. (kg)	Price / ea.	Part Number
		A	B	C	D	D1	J	K			
1 1/8	100	127	114	123.5	32	57	57	25	11.6	809.69	116-1-1/80SPG
1 1/4 - 1 3/8	125	139	127	135	38	63	63	28	16.3	988.29	116-1-1/40SPG
1 1/2	150	152	162	160	41	70	76	30	24	1314.17	116-1-1/20SPG
1 5/8	200	165	165	176	44	76	76	33	27	1600.92	116-1-5/80SPG
1 3/4 - 1 7/8	260	190	178	200	51	89	89	39	38	2417.64	116-1-7/80SPG
2 - 2 1/8	280	216	228	216	57	95	101	46	59	3279.13	116-2-1/80SPG
2 1/4 - 2 3/8	360	228	250	236	63	108	113	53	87	4345.37	116-2-3/80SPG
2 1/2 - 2 5/8	450	248	273	264	73	121	127	60	130	6185.52	116-2-5/80SPG
2 3/4 - 2 7/8	480	279	279	276	79	127	133	73	157	P.O.R	116-2-7/80SP
3 - 3 1/8	520	305	286	284	86	133	146	76	192	6857.75	116-3-1/80SP
3 1/4 - 3 3/8	600	330	298	296	92	140	159	79	243	Pricing on Request	116-3-3/80SP
3 1/2 - 3 5/8	700	356	318	340	99	152	171	83	287		116-3-5/80SP
3 3/4 - 4	875	381	343	362	108	178	191	89	370		116-40SP
4 1/2	1100	460	480	440	125	190	208	101	447		116-4-1/20SP
5	1250	500	500	560	138	250	210	120	750		116-50SP
5 1/2 - 6	1400	580	500	600	160	275	230	140	880		116-60SP
6 1/2	1600	675	600	650	175	290	310	175	1040		116-6-1/20SP

SOCKET - SPELTER, OPEN, GN®

Made in Holland

Cast material, 5:1 safety, 3.1B certificates and material certificate, painted finish, c/w cotter pin. Rated in Metric Ton(s)

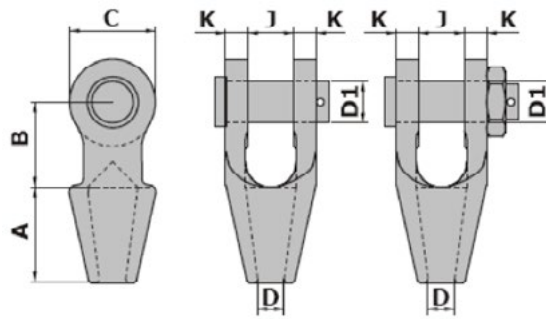

Painted Finish

Wire Size (in)	MBL (t)	Dimensions (mm)							Wt./ea. (kg)	Price / ea.	Part Number
		A	B	C	D	D1	J	K			
1 1/2	150	152	162	160	41	70	76	30	24	1098.66	116-1-1/20SP
1 5/8	200	165	165	176	44	76	76	33	27	1237.54	116-1-5/80SP
1 3/4 - 1 7/8	260	190	178	200	51	89	89	39	38	1961.97	116-1-7/80SP
2 - 2 1/8	280	216	228	216	57	95	101	46	59	2481.14	116-2-1/80SP
2 1/4 - 2 3/8	360	228	250	236	63	108	113	53	87	3441.48	116-2-3/80SP
2 1/2 - 2 5/8	450	248	273	264	73	121	127	60	130	4938.13	116-2-5/80SP

SOCKET - SPELTER, CLOSED, GN®

Made in Holland

Cast material, 5:1 safety, 3.1B certificates and material certificate, galvanized or painted finish. Rated in Metric Ton(s)

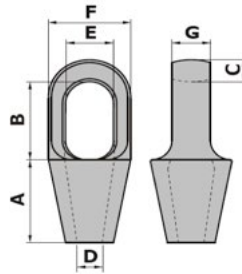

Tolerance + 5%



Galvanized Finish



Painted Finish

Galvanized Finish

Wire Size (in)	MBL (t)	Dimensions (mm)							Wt./ea. (kg)	Price / ea.	Part Number
		A	B	C	D	E	F	G			
1	75	114	103	36	28	57	106	45	6	351.22	116-1CSPG
1 1/8	100	127	116	39	32	63	114	51	7.5	449.23	116-1-1/8CSPG
1 1/4 - 1 3/8	125	139	130	44	38	70	128	58	11	725.07	116-1-1/4CSPG
1 1/2	150	152	155	51	41	79	136	63	13	792.29	116-1-1/2CSP
1 5/8	200	165	171	54	44	82	146	70	17	1029.16	116-1-5/8CSP
1 3/4 - 1 7/8	260	190	198	55	51	89	171	76	24	1576.05	116-1-7/8CSPG
2 - 2 1/8	280	216	224	62	57	96	193	82	37	2344.20	116-2-1/8CSP
2 1/4 - 2 3/8	360	228	247	73	63	108	216	92	56	2915.93	116-2-3/8CSP
2 1/2 - 2 5/8	450	248	270	76	73	140	241	102	65	3386.43	116-2-5/8CSP
2 3/4 - 2 7/8	480	279	286	79	79	159	273	124	93	Pricing on Request	116-2-7/8CSP
3 - 3 1/8	520	305	298	83	86	171	292	133	110		116-3-1/8CSP
3 1/4 - 3 3/8	600	330	311	102	92	184	311	146	142		116-3-3/8CSP
3 1/2 - 3 5/8	700	356	330	102	99	197	330	159	170		116-3-5/8CSP
3 3/4 - 4	875	381	356	108	108	216	362	178	225		116-4CSP
4 1/2	1100	450	425	120	125	235	405	190	340		116-4-1/2CSP
5	1250	500	475	120	138	260	515	205	555		116-5CSP
5 1/2 - 6	1400	580	550	150	160	300	550	225	850		116-6CSP
6 1/2	1600	675	600	175	175	325	600	300	1050		116-6-1/2CSP

Painted Finish (Limited quantities)

Wire Size (in)	MBL (t)	Dimensions (mm)							Wt./ea. (kg)	Price / ea.	Part Number
		A	B	C	D	E	F	G			
1 3/4 - 1 7/8	260	190	198	55	51	89	171	76	24	1,095.29	116-1-7/8CSP

CAUTION: WHILE ATTACHING SPELTER SOCKETS TO WIRE ROPE IT IS EXTREMELY IMPORTANT TO FOLLOW RECOMMENDED PROCEDURES. WHENEVER POSSIBLE THE ASSEMBLY SHOULD BE PROOF LOADED. ALL SLINGS WITH Poured sockets, in accordance with ASME B30.9, shall be proof loaded.

SOCKET - SPELTER, CR, CLOSED (PEEWEE, GOLD NOSE), GN®

Made in Holland

Cast material, 5:1 safety, proof load, 3.1B certificates, on request – MPI. CR sockets are the best possible connection between chain and a wire rope anchoring system. These sockets have a non rotating system that prevents the tamp from turning or slipping out of the cone increasing the performance of the connection. Rated in Metric Ton(s)

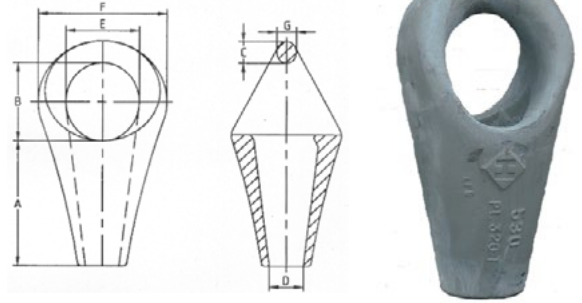

Wire Size (in)	WLL (t)	Dimensions (mm)							Wt./ea. (kg)	Price / ea.	Part Number
		A	B	C	D	E	F	G			
1 1/4 - 1 3/8	28	140	85	38	39	75	124	35	Pricing on Request	116-CR28	
1 1/2 - 1 5/8	32	160	110	42	44	92	130	38		116-CR32	
1 3/4 - 1 7/8	40	188	128	50	51	110	180	45		116-CR40	
2 - 2 1/8	50	215	125	55	57	115	200	50		116-CR50	
2 1/4 - 2 3/8	60	230	145	65	63	135	230	57		116-CR60	
2 1/2 - 2 5/8	80	250	160	75	73	160	265	65		116-CR80	
2 3/4 - 2 7/8	100	280	175	80	79	170	278	70		116-CR100	
3 - 3 1/8	120	315	210	85	86	184	300	75	6229.00	116-CR120	
3 1/4 - 3 3/8	140	340	205	100	92	204	320	90	Pricing on Request	116-CR140	
3 1/2 - 3 5/8	160	360	220	105	99	215	340	95		116-CR160	
3 3/4 - 4	180	380	240	110	108	234	376	100		116-CR180	
4 1/4 - 4 1/2	200	450	260	125	120	252	400	110	186	116-CR200	

CAUTION:
WHILE ATTACHING SPELTER SOCKETS TO WIRE ROPE IT IS EXTREMELY IMPORTANT TO FOLLOW RECOMMENDED PROCEDURES.
WHENEVER POSSIBLE THE ASSEMBLY SHOULD BE PROOF LOADED. ALL SLINGS WITH Poured SOCKETS, IN ACCORDANCE WITH ASME B30.9, SHALL BE PROOF LOADED.

WIRE ROPE BROOM DEGREASER



- Easy to use
- Does not irritate skin
- No objectionable or toxic fumes
- Fresh pine scent
- Non-Corrosive
- Will not harm metal surfaces
- Will not scratch metal surfaces
- MSDS available on request



Size	Price / ea.	Part Number
5 gallon pail	1,210.00	38-93220005

ENVIRONMENTALLY FRIENDLY
 Biodegradable - Non-Toxic / Non-Hazardous
 Chlorine Free - Free of Petroleum Distillates
 Does Not Effect the Ozone

SOCKETING PUTTY

Item	Size	Price / ea.	Part Number
Socketing Putty	1 lb pack (10 packs per case)	14.90	38-91910100



INCOMPATIBILITIES: PRE SOCKET IS NOT RECOMMENDED FOR USE ON LATEX, BUNA N, NEOPRENE, POLYSTYRENE, AND SOME PLASTICS

WARNING: BIODEGRADABLE PRE SOCKET SOAKED RAGS MAY SPONTANEOUSLY COMBUST IN WASTE CONTAINERS. WET PRE SOCKET RAGS WITH WATER TO PREVENT THE RISK OF SPONTANEOUS COMBUSTION. REFER TO MSDS PRIOR TO USE: FOR CHEMICAL EMERGENCY, SPILL, LEAK, FIRE, EXPOSURE OR ACCIDENT. CALL CHEMTREC DAY AND NIGHT: DOMESTIC NORTH AMERICA: 800-424-9300 / INTERNATIONAL: 703-527-3887

SOCKET LOCK - RESIN



- Longer shelf life of 18 months
- MSDS sheets for hassle free shipping to your customers
- Newly formulated after extensive testing for better wire rope grip
- Packaged in environmentally protected pouches and rust-free plastic pails to ensure product freshness
- Disposable pouring funnel included in each kit helps eliminate spills
- Bright green resin and white hardener makes mixing easy to verify
- Packaged in CCs and individually sized kits to minimize waste and aid in easy mixing
- Non-dusting, safe to use formula contains no dry powders that become airborne health hazards



Size	Kits per Case	Booster Kits (sold individually)		Socket Lock	
		Price / ea.	Part Number	Price / ea.	Part Number
250 cc	12	17.71	38-10840250	128.08	38-10900010
500 cc	12	23.29	38-10840500	173.50	38-10900020
1000 cc	6	28.00	38-10841000	343.76	38-10900030

RESIN SOCKETING WARNING AND SAFETY INFORMATION, SEE PAGE 308

RESIN SOCKETING WARNING AND SAFETY INFORMATION



Ambient Temperature*		Booster Packs Required	Approximate Gel Time (Working Time)*	Approximate Cure Time (Ready For Service)
°F	°C	Packs	Minutes	Hours
110	43	None	3-4	1
105	41	None	3-4	1
100	38	None	4-5	1
95	35	None	5-6	1
90	32	None	6-8	1
85	29	None	8-10	1
80	27	None	11-13	1
75	24	None	13-16	1
70	21	None	16-20	1
65	18	None	20-25	1
60	16	None	23-28	1
55	13	1	17-23	1
50	10	1	24-30	1
45	7	1	30-36	2
40	4	1	50-60	2.5
35	2	1	70-85	4.5
30	-1	1	100-120	6.5

NOTE:

- Times are approximate. The temperature of the resin, socket and wire rope can affect these times. The times above are based on the temperature of the resin at the time of mixing.
- Thorough mixing is required to achieve appropriate times listed in the table to the right.
- Approximate time to gel begins once resin has been mixed.
- Approximate time to cure begins once resin has gelled.

WARNINGS

- Inspect inside of socket bowl to determine if socket has grooves. If grooves are present, fill grooves with socketing putty.
- If using wire for seizing, only use soft annealed iron wire.
- Socket Lock resin must be gelled and cured before assembly can be used.
- Socket Lock is not to be used with stainless steel rope in a salt water environment.
- Never use oversized sockets for wire rope unless you consult the socket and wire rope manufacturer.
- Never use Socket Lock beyond the expiration date.
- Never heat socket prior to pouring resin in an effort to accelerate the curing of the resin as it may cause the resin to prematurely gel prior to reaching the bottom of the socket bowl. Doing this could cause the assembly to fail.
- Caution: Exposure to some strong chemicals may affect the cured polymer (hardened resin mixture) in a way that could weaken the assembly. Please contact the manufacturer if this has occurred.

Socket Size		CCs
inches	mm	
1/4"	6-7	9
5/16" - 3/8"	8-10	17
7/16" - 1/2"	11 - 13	35
9/16" - 5/8"	14 - 16	52
3/4"	19	86
7/8"	22	131
1"	26	164
1 1/8"	29	210
1 1/4" - 1 3/8"	32 - 35	361
1 1/2"	37	426
1 5/8"	42	495
1 3/4" - 1 7/8"	43 - 48	737
2" - 2 1/8"	51 - 54	1,265
2 1/4" - 2 3/8"	55 - 60	1,475
2 1/2" - 2 5/8"	61 - 68	1,966
2 3/4" - 2 7/8"	69 - 75	2,294
3" - 3 1/8"	76 - 80	3,277
3 1/4" - 3 3/8"	81 - 87	3,933
3 1/2" - 3 5/8"	88 - 93	4,920
3 3/4" - 4"	94 - 103	7,784

NOTE: Socket volumes are approximate and may vary according to manufacturer

SAFETY INFORMATION

- When handling the resin or hardener, goggles and protective clothing are recommended. Impervious gloves are recommended.
- Always work in a ventilated area.
- Avoid skin or eye contact. Wash skin with soap and water and remove contaminated clothing. If contact with eyes, flush with clean water for at least 15 minutes. If irritation persists, seek medical attention.
- Avoid ingestion. If ingestion occurs, DO NOT induce vomiting. Drink milk or water to dilute and call for medical attention.
- Avoid inhaling vapors. If excessive vapors are inhaled, move to a fresh air area. If breathing has stopped or is labored seek medical attention.
- Never aim an open flame at Socket Lock. Keep away from heat. Resin is a flammable liquid.
- Whenever using chemicals, always reference the MSDS sheet for safety and handling guidelines.

VISIT socket-locket.com FOR FULL INFORMATION BROCHURE!

SOCKET - SWAGE, CLOSED, FORGED

- Swage sockets properly applied have an efficiency rating of 100% based on catalog strength of wire rope.
- Swage sockets are recommended for use with 6x19, 6x37, IWRC wire rope, and galvanized bridge rope.
- Swage sockets are not recommended for use on fiber core or lang lay wire rope.

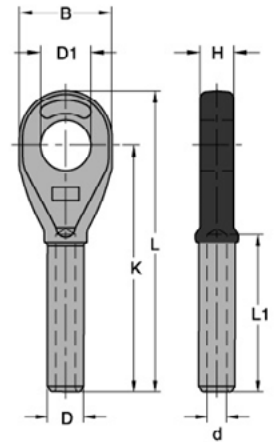

Rope (in)	Before Swage Dimensions (in)								Max. after Swage (in)	Wt./ea. (lb)	Price / ea.	Part Number
	B	D	D1	d	H	K	L	L1				
1/4	1.38	0.50	0.75	0.27	0.50	3.50	4.33	2.13	0.46	0.3	82.64	28-1/4CSS
5/16	1.63	0.77	0.89	0.34	0.67	4.50	5.50	3.15	0.71	0.8	102.56	28-5/16CSS
3/8	1.63	0.77	0.89	0.41	0.67	4.50	5.50	3.15	0.71	0.7	102.56	28-3/8CSS
1/2	2.00	0.98	1.06	0.55	0.89	5.75	6.93	4.25	0.91	1.4	125.03	28-1/2CSS
5/8	2.40	1.25	1.26	0.67	1.14	7.28	8.70	5.31	1.16	2.9	184.07	28-5/8CSS
3/4	2.87	1.55	1.44	0.80	1.31	8.54	10.20	6.38	1.42	5.0	260.26	28-3/4CSS
7/8	3.11	1.70	1.70	0.94	1.50	10.16	11.97	7.44	1.55	6.8	385.72	28-7/8CSS
1	3.62	1.98	2.05	1.06	1.77	11.54	13.46	8.50	1.80	10.4	524.14	28-1CSS
1-1/8	4.02	2.25	2.32	1.19	2.00	12.72	15.04	9.57	2.05	14.8	602.54	28-1-1/8CSS
1-1/4	4.50	2.53	2.56	1.33	2.25	14.33	16.97	10.63	2.30	21.6	888.60	28-1-1/4CSS
1-3/8	5.00	2.80	2.56	1.45	2.25	15.83	18.70	11.69	2.56	28.4	1158.43	28-1-3/8CSS
1-1/2	5.50	3.08	2.81	1.58	2.52	17.01	20.12	12.75	2.81	38.1	1280.55	28-1-1/2CSS

SOCKET - SWAGE, OPEN, FORGED

- Swage sockets properly applied have an efficiency rating of 100% based on catalog strength of wire rope.
- Swage sockets are recommended for use with 6x19, 6x37, IWRC wire rope, and galvanized bridge rope.
- Swage sockets are not recommended for use on fiber core or lang lay wire rope.

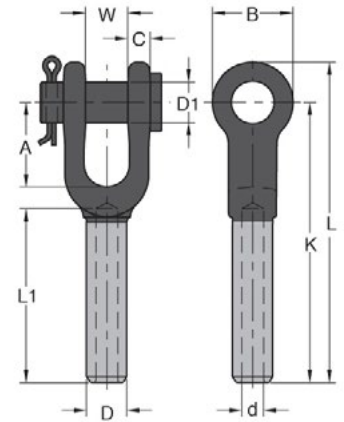

Rope (in)	Before Swage Dimensions (in)										Max. after Swage (in)	Wt./ ea. (lb)	Price/ ea.	Part Number
	A	B	C	D	D1	d	K	L	L1	W				
1/4	1.50	1.38	0.35	0.50	0.69	0.27	4.02	4.80	2.17	0.67	0.46	0.5	116.52	28-1/40SS
5/16	1.77	1.65	0.47	0.77	0.81	0.34	5.31	6.26	3.15	0.79	0.71	1.1	146.22	28-5/160SS
3/8	1.77	1.65	0.47	0.77	0.81	0.41	5.31	6.26	3.15	0.79	0.71	1.3	163.80	28-3/80SS
1/2	1.96	2.00	0.55	0.98	1.00	0.55	6.85	7.83	4.33	1.00	0.91	2.1	193.57	28-1/20SS
9/16	2.25	2.36	0.68	1.25	1.19	0.61	8.27	9.45	5.31	1.22	1.16	4.7	301.08	28-9/160SS
5/8	2.25	2.36	0.68	1.25	1.19	0.67	8.27	9.45	5.31	1.22	1.16	4.5	271.10	28-5/80SS
3/4	2.75	2.75	0.79	1.55	1.38	0.80	10.07	11.61	6.34	1.50	1.42	8.0	390.54	28-3/40SS
7/8	3.23	3.15	0.94	1.70	1.63	0.94	11.81	13.39	7.44	1.77	1.55	11.5	594.81	28-7/80SS
1	3.86	3.94	1.02	1.98	2.00	1.06	13.58	15.55	8.50	2.00	1.80	17.8	761.66	28-10SS
1-1/8	4.26	4.06	1.19	2.25	2.20	1.19	15.08	17.40	9.37	2.25	2.05	25.3	1056.30	28-1-1/80SS
1-1/4	4.72	4.45	1.34	2.53	2.48	1.33	16.50	19.06	10.59	2.48	2.30	35.6	1311.24	28-1-1/40SS
1-3/8	5.20	5.00	1.38	2.80	2.50	1.45	18.23	21.02	11.69	2.52	2.56	45.9	1569.95	28-1-3/80SS
1-1/2	5.75	5.51	1.69	3.08	2.75	1.58	19.75	22.88	12.40	3.00	2.81	58.5	2002.65	28-1-1/20SS

SOCKET - CLIPINATOR WEDGE SOCKET

- Standard: ASME B30.26
- Efficiency rating of 80% of wire breaking strength
- Secures the tail of the wire to the wedge
- Stops tail from getting deformed when clipped

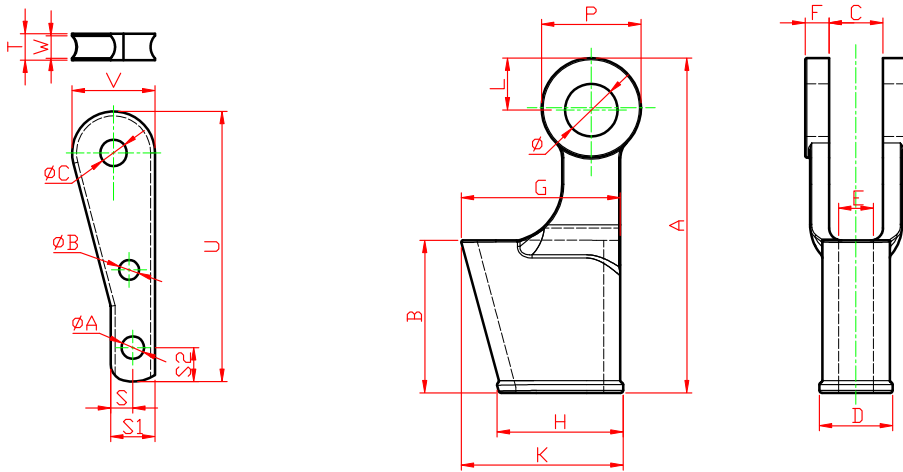

Price	Part Number
62.94	6-3/80WS
121.05	6-1/20WS
207.22	6-5/80WS
264.97	6-3/40WS
353.37	6-7/80WS
596.30	6-10WS
763.21	6-1-1/80WS
1164.18	6-1-1/40WS

SIZE	A	B	C	D	E	F	G	H	K	L	P	T	U	V	W	Ø	ØA	ØB	ØC	S	S1	S2	
3/8	145		20.6	35.1		11.2			69	22.4	39.6	11.2		35									
1/2	175		25.4	41.1		12.7			88	26.9	49.3	13.5		48									
5/8	235	94	31.8	54.4	22.4	14.2	111	94	114	31	57.4	17.5	189	57	12.8	29	15	15	18	16.7	32.2	20.7	
3/4	251		38.2	67.8	29	17	130		130	33.5	66.8	21	202	65	12.2	35	17.8	15.6	20				
7/8	285.5	128	45	61	29	19	144.5	114.5	146.5	39.4	79	23	243	79	16.8	42	22	18.4	26.3	23.2	46.5	35.3	
1	325.5	146	51.5	69	34	22.5	158.5	126.5	161	50	94.5	26	267.5	88	22.4	52	23	20.3	28.5	24.7	49.5	39.5	
1-1/8	369.5	169	57	83	40.5	26.5	177.5	143.5	182	57	109	28	312.5	100	23.2	58.5	23	20	30.3	27.5	55	40	
1-1/4	404	184	65	88.5	42	29	192	152	195	62.8	120	31	326	125	26	63.5	27.2	24	32	39	78	41	

WEDGE SOCKET WARNINGS AND USE

- Always inspect socket, wedge and pin before using.
- Do not use any part that is showing cracks, do not repair by welding.
- Do not modify or substitute any parts.
- Inspect assemblies before use.
- Do not mix and match wedges or pins between sizes.
- Always select the wedge and socket for the wire rope size.
- Use only with standard 6 to 8 strand wire rope of designated size, for intermediate size rope, use next larger size socket.
- Welding of tail on standard wire rope is not recommended, the tail length of the dead end should be a minimum of 6 rope diameters but not less than 6".
- Secure dead end section of rope. DO NOT ATTACH DEAD END TO LIVE END.
- Use a hammer to seat the wedge and rope as deep into socket as possible before applying first load.
- To use with rotation resistant wire rope, ensure that the dead end is welded or seized before inserting the wire rope into the wedge socket to prevent core slippage or loss of rope lay. The tail length of the dead end should be a minimum of 20 rope diameters but not less than 6".
- Efficiency rating of the wedge socket termination is based on the catalog breaking strength of wire rope. The efficiency of properly assembled wedge socket is 80%.

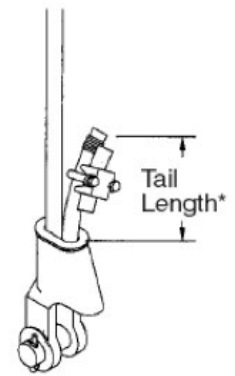

RIGHT



WRONG



WRONG

- LOADS MAY SLIP OR FALL IF THE WEDGE SOCKET IS NOT PROPERLY INSTALLED.
- A FALLING LOAD CAN SERIOUSLY INJURE OR KILL.
- READ AND UNDERSTAND THESE INSTRUCTIONS BEFORE INSTALLING THE WEDGE SOCKET.
- DO NOT SIDE LOAD THE WEDGE SOCKET.
- DO NOT INTERCHANGE WEDGE SOCKET, WEDGE OR PIN WITH OTHER MANUFACTURES SOCKET, WEDGE OR PIN.
- APPLY FIRST LOAD TO FULLY SEAT THE WEDGE AND WIRE ROPE IN THE SOCKET. THIS LOAD SHOULD BE OF EQUAL OR GREATER WEIGHT THAN LOADS EXPECTED IN USE.
- DO NOT INTERCHANGE WEDGE BETWEEN SIZES.

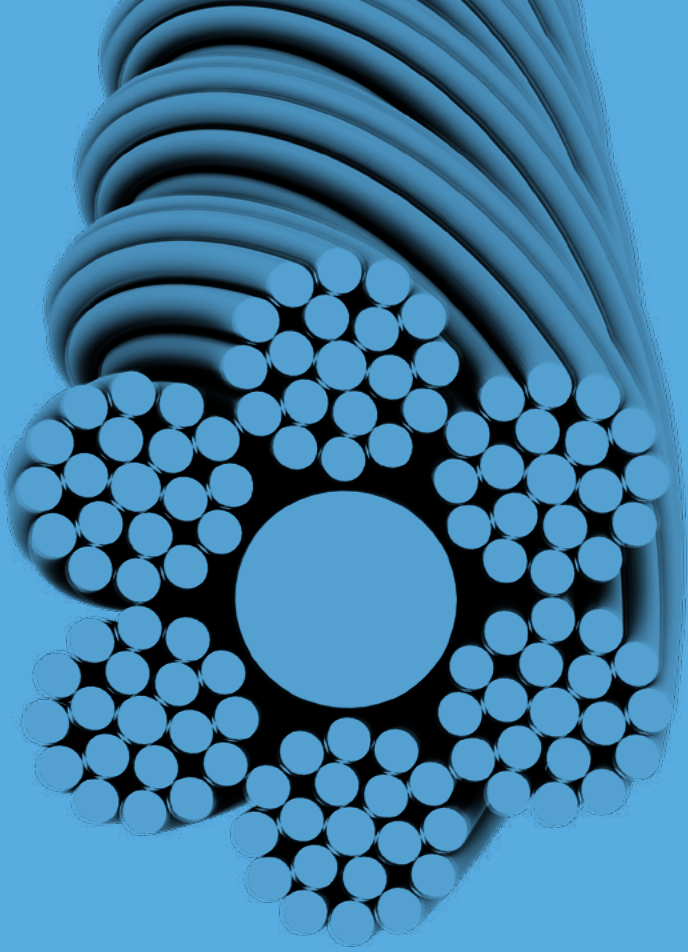

WIRE ROPE

Wire Rope Lubricant	289
7x7 & 7x19 GAC & PVC GAC	292 - 293
7x7, 7x19, 6x19, 6x26 Stainless Steel Wire	294
7x7 & 7x19 PVC Stainless Steel Wire	295
1x7 Stainless Seizing Wire	295
6x19 & 6x24 Fiber Core	296 - 297
6x26 Regular Swaged Wire Rope	297
6x19, 6x26, 6x36 IWRC	298 - 302
8x26, 18x19, 19x7, 6x25, 6x37 Wire Ropes	303 - 305
35x7, 8x19, 8x36 Wire Ropes.....	306 - 309

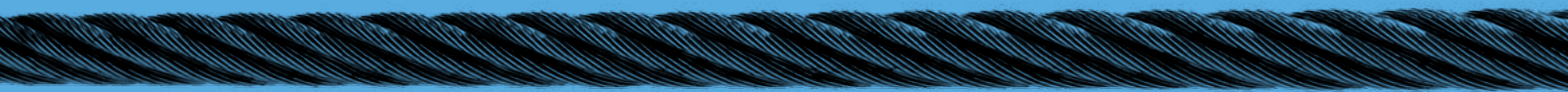

SEA LUBE WIRE ROPE LUBRICANT

- Sea Lube penetrates with a lubricating film that displaces moisture and prevents corrosion.
- Sea Lube guards against surface corrosion from atmospheric, salt, water and acid exposure.
- Sea Lube will not drip or run off surface even at elevated temperatures. Finished coating is dry to the touch. Protects metals, alloys and painted surfaces.



**AVAILABLE IN AEROSOL CANS,
5 GAL PAILS & 55 GAL DRUMS.**

Size	Packagin	Price / ea.	Part Number
12 oz aerosol can	12 cans per case	62.50 / can	38-93200000
5 gallon pail	Sold individually	779.00 / each	38-93200001
55 gallon drum	Sold individually	Pricing on Request	38-93200002

MADE IN USA



OCEANSIDE EQUIPMENT LTD, EXCLUSIVE CANADIAN DEALER FOR JIANGSU LANGSHAN WIRE ROPE CO. LTD., THE WORLDS LARGEST WIRE ROPE FACTORY

Jiangsu Wire Rope Mill is a large scale, high tech enterprise and is one of the earliest enterprises in its country specializing in steel wire and steel wire rope sling manufacturing with an annual output of 1,560,000 metric ton, 78,000 containers with a capacity of producing up to 8" diameter wire ropes! With 50 years experience in production they are well equipped with advanced technology and have a complete means of measuring and testing capabilities with the continuous adoption of new equipment, new production processes, new technology and the development of new products.

worldwide known standards like GB, DIN, BS, JIS, ASTM, RR-W-410, API, ISO, and so on. They have already passed the quality system verification of API, ISO9001. Factory through CCS, Lloyd's, ABS, BV, and DNV Factory Certification. In 2006 the products were awarded as the "National Inspection-Free Product".

The company has always attached great importance to product quality, its reputation and that the products are well accepted around the world.

The products manufactured can be organized according to

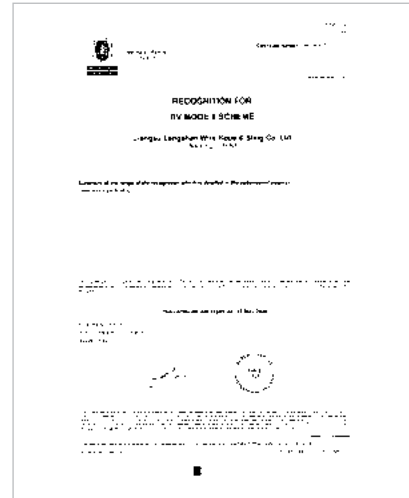

JIANGSU LANGSHAN WIRE ROPE CO. LTD. THE WORLDS LARGEST WIRE ROPE FACTORY



WIRE ROPE



9A-0055



Lloyd's Register



ABS



WIRE ROPE - 7X7 & 7X19, AIRCRAFT CABLE, STEEL CORE, GALVANIZED

- Material: Improved Plow Steel (Grade 1770)
- Standard: MIL-W-83420D
- Finish: Drawn Galvanized, Lube: Dry
- Lay: ROL (sZ) / Core: IWRC
- Construction: 7x7 & 7x19

- Certification: Manufacturers (on request)

Note: Reel material differs between; Wood, Metal, and Plastic.

*Actual loads may vary.

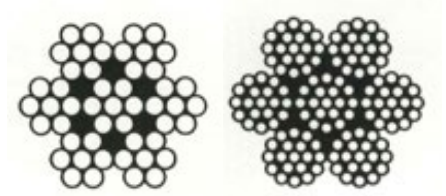

Diameter (in)	Tolerance (in)	*MBF (lb)	Construction	Wt./1000 ft (lb)	Qty. / Reel (ft)	Price / Reel	Part Number
1/16	0.010	480	7 x 7	7.5	500	37.10	WR-7X7-1/16X500
1/16	0.010	480	7 x 7	7.5	1000	71.94	WR-7X7-1/16X1000
3/32	0.012	920	7 x 7	16.0	500	63.59	WR-7X7-3/32X500
3/32	0.012	920	7 x 7	16.0	1000	124.76	WR-7X7-3/32X1000
1/8	0.014	1700	7 x 7	28.5	500	88.34	WR-7X7-1/8X500
1/8	0.014	1700	7 x 7	28.5	1000	172.97	WR-7X7-1/8X1000
1/8	0.014	2000	7 x 19	29.0	1000	233.42	WR-7X19-1/8
5/32	0.016	2600	7 x 7	43.0	500	124.86	WR-7X7-5/32X500
5/32	0.016	2600	7 x 7	43.0	1000	245.34	WR-7X7-5/32X1000
5/32	0.016	2800	7 x 19	45.0	1000	311.70	WR-7X19-5/32
3/16	0.018	3700	7 x 7	62.0	500	174.85	WR-7X7-3/16X500
3/16	0.018	3700	7 x 7	62.0	1000	343.05	WR-7X7-3/16X1000
3/16	0.018	4200	7 x 19	65.0	250	98.79	WR-7X19-3/16X250
3/16	0.018	4200	7 x 19	65.0	500	188.68	WR-7X19-3/16X500
3/16	0.018	4200	7 x 19	65.0	1000	369.87	WR-7X19-3/16X1000
3/16	0.018	4200	7 x 19	65.0	5000	1796.70	WR-7X19-3/16
1/4	0.018	7000	7 x 19	110.0	250	157.30	WR-7X19-1/4X250
1/4	0.018	7000	7 x 19	110.0	500	301.24	WR-7X19-1/4X500
1/4	0.018	7000	7 x 19	110.0	1000	591.40	WR-7X19-1/4X1000
1/4	0.018	7000	7 x 19	110.0	5000	2721.80	WR-7X19-1/4
5/16	0.022	9800	7 x 19	173.0	500	438.85	WR-7X19-5/16X500
5/16	0.022	9800	7 x 19	173.0	1000	877.72	WR-7X19-5/16X1000
5/16	0.022	9800	7 x 19	173.0	5000	4179.86	WR-7X19-5/16
3/8	0.026	14 400	7 x 19	243.0	110	143.60	WR-7X19-3/8X110
3/8	0.026	14 400	7 x 19	243.0	500	596.23	WR-7X19-3/8X500
3/8	0.026	14 400	7 x 19	243.0	1000	1170.09	WR-7X19-3/8X1000
3/8	0.026	14 400	7 x 19	243.0	5000	5677.39	WR-7X19-3/8

NOT FOR AIRCRAFT USE - SOLD IN FULL REELS ONLY

WIRE ROPE - 7X7 & 7X19, AIRCRAFT CABLE, PVC COATED, STEEL CORE, GALVANIZED

- Material: Improved Plow Steel (Grade 1770)
- Standard: MIL-W-83420D
- Finish: Drawn Galvanized / PVC Coated - Clear, Lube: Dry
- Lay: ROL (sZ) / Core: IWRC
- Construction: 7x7 & 7x19
- Certification: Manufacturers (on request)

*Actual loads may vary.

*Note: Diameter A: PVC Coating removed, raw steel cable.
Diameter B: PVC Coating not removed.

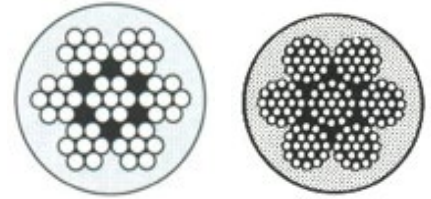

*Diameter (in)		MBF (lb)	Construction	Wt. / 1000 ft (lb)	Qty. / Reel (ft)	Price / ft	Part Number
A	B						
1/8	3/16	1700	7 x 7	36.2	Bulk	0.36	WR-PVC3/16"-7
3/16	1/4	4200	7 x 19	77.5	Bulk	0.71	WR-PVC1/4"-7
1/4	5/16	7000	7 x 19	123	Bulk	1.01	WR-PVC-5/16"
5/16	3/8	9800	7 x 19	197	Bulk	1.48	WR-PVC3/8"

NOT FOR AIRCRAFT USE



WIRE ROPE - 7X7, 7X19, 6X19, 6X26, STEEL CORE, STAINLESS

- Material: Improved Plow Steel (Grade 1770), 304 & 316 Stainless (ANSI 316)
- Standard: MIL-W-83420D, ASTM A492, ISO 2408, RR-W-410G, API-9A
- Finish: Stainless Steel, Lube: Dry
- Lay: ROL (sZ) / Core: IWRC
- Construction: 7x7 & 7x19 & 6x19 & 6x26
- Certification: Manufacturers (on request)
- * Actual loads may vary.

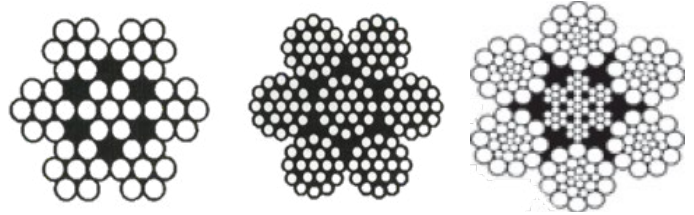

Diameter (in)	*MBF (lb)	Construction	Grade Stainless	Qty. / Reel (ft)	Price / Reel or ft	Part Number
1/16	480	7 x 7	304	*Bulk	0.27	WRSS-7X7-1/16
1/16	480	7 x 7	304	500	100.73	WRSS-7X7-1/16X500
3/32	920	7 x 7	304	*Bulk	0.31	WRSS-7X7-3/32
1/8	1700	7 x 7	304	*Bulk	0.53	WRSS-7X7-1/8
1/8	1700	7 x 7	304	250	143.93	WRSS-7X7-1/8X250
1/8	1760	7 x 19	304	1000	623.07	WRSS-7X19-1/8X1000
1/8	1760	7 x 19	304	*Bulk	0.60	WRSS-7X19-1/8
5/32	2400	7 x 7	304	*Bulk	0.75	WRSS-7X7-5/32
3/16	3700	7x19	304	Bulk	1.22	WRSS-7X19-3/16
1/4	6400	7 x 19	304	*Bulk	1.82	WRSS-7X19-1/4
5/16	9000	7 x 19	304	*Bulk	2.70	WRSS-7X19-5/16
3/8	12 000	7 x 19	304	*Bulk	3.79	WRSS-7X19-3/8
1/2	19 300	6 x 26	316	*Bulk	8.80	WRSS-6X19-1/2"
5/8	32 250	6 x 26	316	*Bulk	14.39	WRSS-6x26-5/8
3/4	44 600	6 x 26	316	*Bulk	20.15	WRSS-6x26-3/4

*Note: Bulk pricing is subject to labor and material charges.
Pricing based on Full reel lengths, Custom lengths will be subject to reel charge and Labour.

WIRE ROPE - 7X7, 7X19, AIRCRAFT CABLE, PVC COATED, STEEL CORE, STAINLESS

- Material: Improved Plow Steel (Grade 1770), 316 Stainless (ANSI 316)
- Standard: MIL-W-83420D, ASTM A492
- Finish: Stainless Steel, Lube: Dry
- Lay: ROL (sZ) / Core: IWRC
- Construction: 7x7 & 7x19
- Certification: Manufacturers (on request)

*Actual loads may vary.

*Note: Diameter A: PVC Coating removed, steel cable only. Diameter B: PVC Coating not removed.

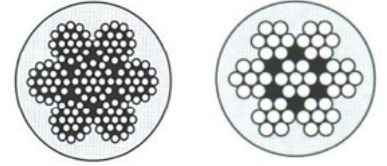

*Diameter (in)		*MBF (lb)	Construction	Price / ft	Part Number
A	B				
1/8	3/16	1700	7 x 7	1.11	WRSS-PVC-1/8
3/16	1/4	3700	7 x 19	2.01	WRSS-PVC1/4"
1/4	5/16	6400	7 x 19	3.15	WRSS-PVC5/16"
5/16	3/8	9000	7 x 19	4.53	WRSS-PVC3/8"

WIRE ROPE - 6X19, TRAWL WARP, FIBER CORE, GALVANIZED & GREASED

- Material: Improved Plow Steel (Grade 1770)
- Standard: ISO 2408, RR-W-410G, API-9A
- Finish: Drawn Galvanized, Lube: A1 Light Lube
- Lay: ROL (sZ) / Core: FC
- Construction: 6x19
- Certification: Manufacturers (on request)

*Actual loads may vary.

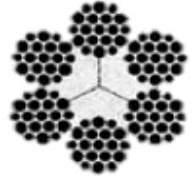

Diameter (in)	*MBF (lb)	Weight / ft (lb)	Price / ft	Part Number
3/8	12 200	0.24	1.40	WR-6X19-3/8"
7/16	16 540	0.32	1.96	WR-6X19-7/16"
1/2	21 400	0.42	2.37	WR-6X19-1/2"
9/16	27 000	0.53	2.93	WR-6X19-9/16"
5/8	33 400	0.66	3.64	WR-6X19-5/8"
3/4	47 600	0.95	5.12	WR-6X19-3/4"

WIRE ROPE - 6X19, BRIDLE WIRE, FIBER CORE, GALVANIZED

- Material: Improved Plow Steel (Grade 1770)
- Standard: ISO 2408, RR-W-410G, API-9A
- Finish: Drawn Galvanized, Lube: Dry
- Lay: ROL (sZ) / Core: FC
- Construction: 6x19
- Certification: Manufacturers (on request)

*Actual loads may vary.

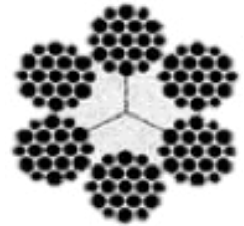

Diameter (in)	*MBF (lb)	Weight / ft (lb)	Price / ft	Part Number
3/8	12 200	0.24	1.40	WRD-6X19-3/8"
1/2	21 400	0.42	2.37	WRD-6X19-1/2"
9/16	27 000	0.53	2.93	WRD-6X19-9/16"
5/8	33 400	0.66	3.64	WRD-6X19-5/8"
3/4	47 600	0.95	5.12	WRD-6X19-3/4"
7/8	64 400	1.29	6.81	WR-6X19-7/8"

WIRE ROPE - 6X24, FIBER CORE, GALVANIZED

- Material: Improved Plow Steel (Grade 1770)
- Standard: ISO 2408, RR-W-410G, API-9A
- Finish: Drawn Galvanized, Lube: Dry
- Lay: ROL (sZ) / Core: FC
- Construction: 6x24
- Certification: Manufacturers (on request)
- *Actual loads may vary.



Diameter (in)	*MBF (lb)	Weight / ft (lb)	Price / ft	Part Number
9/16	21 200	0.44	2.28	WR-6X24-9/16"
5/8	26 000	0.54	2.81	WR-6X24-5/8"
3/4	26 000	0.54	4.19	WR-6X24-3/4"

WIRE ROPE - 6X26, REGULAR SWAGED WS, STEEL CORE, BRIGHT & GREASED

- Material: Extra Improved Plow Steel (Grade 1960)
- Standard: ISO 2408, RR-W-410G, API-9A
- Finish: Bright, Lube: A1 Light Lube
- Lay: ROL (sZ) / Core: IWRC
- Construction: 6x26, Regular Swaged
- Certification: Manufacturers (on request)
- *Actual loads may vary.

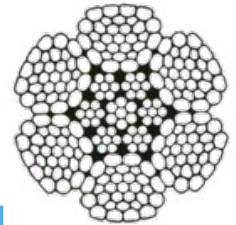

Diameter (in)	*MBF (lb)	Weight / ft (lb)	Price / ft	Part Number
3/8	18 500	0.35	2.67	WR-6X26RS-3/8"
7/16	24 300	0.49	3.03	WR-6X26RS-7/16"
1/2	31 000	0.61	3.59	WR-6X26RS-1/2"
9/16	39 200	0.78	4.37	WR-6X26RS-9/16"
5/8	48 400	0.97	5.01	WR-6X26RS-5/8"

WIRE ROPE - 6X19, STEEL CORE, GALVANIZED

- Material: Improved Plow Steel
- (Grade 1770)
- Standard: ISO 2408, RR-W-410G, API-9A
- Finish: Drawn Galvanized, Lube: Dry
- Lay: ROL (sZ) / Core: IWRC
- Construction: 6x19
- Certification: Manufacturers (on request)

*Actual loads may vary.

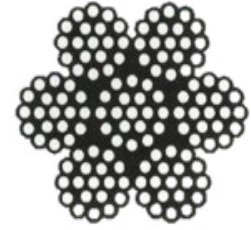

Diameter (in)	*MBF (lb)	Weight / ft (lb)	Qty. / Reel (ft)	Price / ft	Part Number
1/2	23 000	0.46	5 000	2.13	WRG-6X19-1/2"
5/8	35 400	0.72	5 000	2.81	WRG-6X19-5/8"
3/4	51 200	1.04	5 000	4.27	WRG-6X19-3/4"

WIRE ROPE - 6X19, STEEL CORE, GALVANIZED & GREASED

- Material: Extra Improved Plow Steel
- (Grade 1960)
- Standard: ISO 2408, RR-W-410G, API-9A
- Finish: Drawn Galvanized, Lube: A1 Light Lube
- Lay: ROL (sZ) / Core: IWRC
- Construction: 6x19
- Certification: Manufacturers (on request)

*Actual loads may vary.

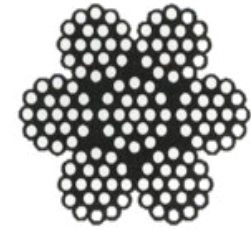

Diameter (in)	*MBF (lb)	Weight / ft (lb)	Qty. / Reel (ft)	Price / ft	Part Number
1 1/8	130 000	2.34	2 332	11.49	WRGA1-6X19-1-1/8"
1 1/4	159 800	2.89	2 332	14.36	WRGA1-6X19-1-1/4"

WIRE ROPE - 6X36, STEEL CORE, GALVANIZED & GREASED

- Material: Extra Improved Plow Steel (Grade 1960)
- Standard: ISO 2408, RR-W-410G, API-9A
- Finish: Bright, Lube: A1 Light Lube
- Lay: ROL (sZ) / Core: IWRC
- Construction: 6x36, Compacted
- Certification: Manufacturers (on request)

*Actual loads may vary.

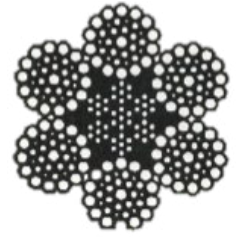

Diameter (in)	*MBF (lb)	Weight / ft (lb)	Price / ft	Part Number
1-1/2	228 000	4.16	22.66	WRGA1-6x36-1-1/2"

WIRE ROPE - 6X26, STEEL CORE, BRIGHT & GREASED

- Material: Extra Improved Plow Steel (Grade 1960)
- Standard: ISO 2408, RR-W-410G, API-9A
- Finish: Bright, Lube: A1 Light Lube
- Lay: ROL (sZ) / Core: IWRC
- Construction: 6x26
- Certification: Manufacturers (on request)

*Actual loads may vary.

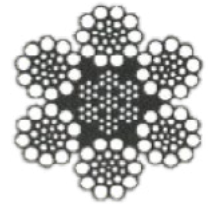

Diameter (in)	*MBF (lb)	Weight / ft (lb)	Qty. / Reel (ft)	Price / ft Full Reel Only	Price / ft	Part Number
3/8	15 100	0.26	5000	1.24	1.49	WRB-6X26-3/8"
7/16	20 400	0.35	5000	1.60	1.92	WRB-6x26-7/16"
1/2	26 600	0.46	5000	2.04	2.44	WRB-6X26-1/2"
9/16	33 600	0.59	5000	2.52	3.02	WRB-6X26-9/16"
5/8	41 200	0.72	5000	3.05	3.65	WRB-6X26-5/8"
3/4	58 800	1.04	2500, 5000	4.23	5.07	WRB-6X26-3/4"
7/8	79 600	1.42	2500	5.79	6.94	WRB-6X26-7/8"
1	103 400	1.85	2500	7.37	8.84	WRB-6X26-1"
1-1/8	130 000	2.34	2500	9.30	11.02	WRB-6X26-1-1/8"

WIRE ROPE - 6X36, STEEL CORE, BRIGHT & GREASED

- Material: Extra Improved Plow Steel (Grade 1960)
- Standard: ISO 2408, RR-W-410G, API-9A
- Finish: Bright, Lube: A1 Light Lube
- Lay: ROL (sZ) / Core: IWRC
- Construction: 6x36
- Certification: Manufacturers (on request)
- *Actual loads may vary.

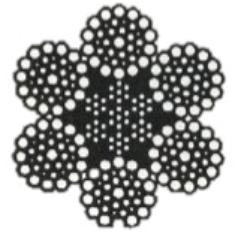

Diameter (in)	*MBF (lb)	Weight / ft (lb)	Qty. / Reel (ft)	Price / ft Full Reel Only	Price / ft	Part Number
5/16	10 540	0.18	5000	1.07	1.28	WRB-6X36-5/16"
3/8	15 100	0.26	5000	1.29	1.55	WRB-6X36-3/8"
7/16	20 400	0.35	5000	1.66	1.99	WRB-6X36-7/16"
1/2	26 600	0.46	5000	2.09	2.50	WRB-6X36-1/2"
9/16	33 600	0.59	5000	2.60	3.12	WRB-6X36-9/16"
5/8	41 200	0.72	5000	3.10	3.72	WRB-6X36-5/8"
3/4	58 800	1.04	5000	4.33	5.19	WRB-6X36-3/4"
7/8	79 600	1.42	2500	5.90	7.07	WRB-6X36-7/8"
1	103 400	1.85	2500	7.57	9.08	WRB-6X36-1"
1-1/16	116 700	2.10	2000	8.56	10.26	WRB-6X36-1-1/16"
1-1/8	130 000	2.34	2500	9.89	11.87	WRB-6X36-1-1/8"
1-1/4	159 800	2.89	2000	12.09	14.50	WRB-6X36-1-1/4"

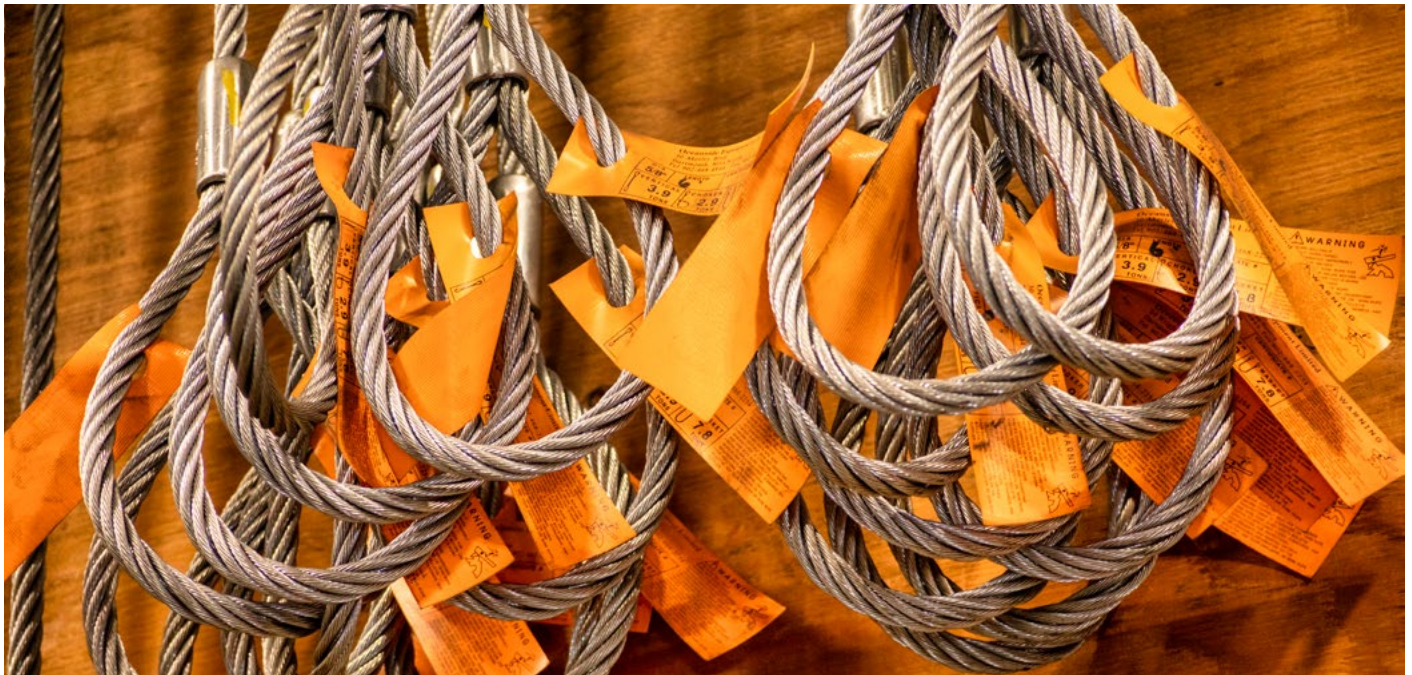

WIRE ROPE - 6X26, STEEL CORE, GALVANIZED

- Material: Extra Improved Plow Steel (Grade 1960)
 - Standard: ISO 2408, RR-W-410G, API-9A
 - Finish: Drawn Galvanized, Lube: Dry
 - Lay: ROL (sZ) / Core: IWRC
 - Construction: 6x26
 - Certification: Manufacturers (on request)
- *Actual loads may vary.

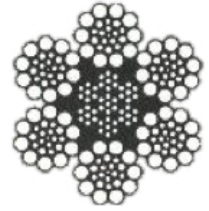

Diameter (in)	*MBF (lb)	Weight / ft (lb)	Qty. / Reel (ft)	Price / ft Full Reel Only	Price / ft	Part Number
3/8	15 100	0.26	5000	1.49	1.79	WRG-6X26-3/8"
7/16	20 400	0.35	5000	1.93	2.32	WRG-6X26-7/16"
1/2	26 600	0.46	5000	2.48	2.97	WRG-6X26-1/2"
9/16	33 600	0.59	5000	3.08	3.70	WRG-6X26-9/16"
5/8	41 200	0.72	5000	3.73	4.48	WRG-6X26-5/8"
3/4	58 800	1.04	5000	5.20	6.24	WRG-6X26-3/4"
7/8	79 600	1.42	2500	7.13	8.56	WRG-6X26-7/8"
1	103 400	1.85	2500	9.12	10.95	WRG-6X26-1"
1-1/8	130 000	2.34	2500	11.46	13.75	WRG-6X26-11/8"

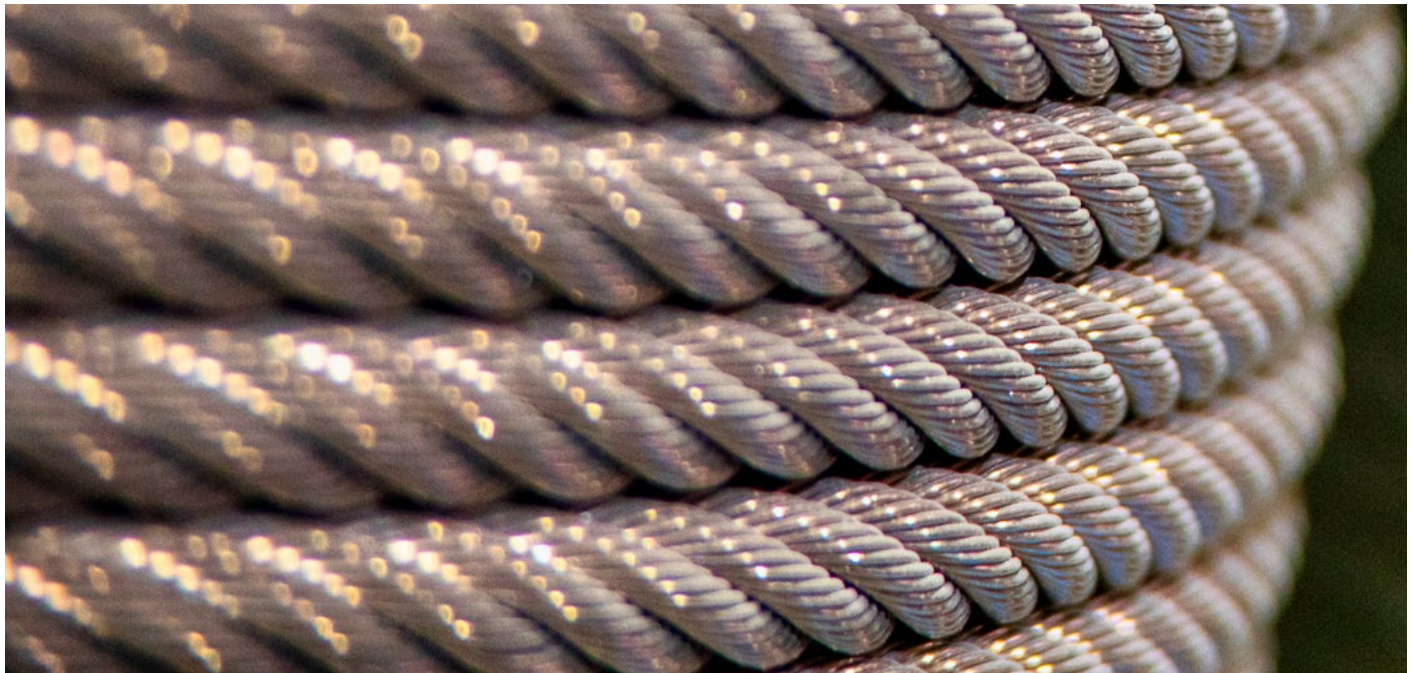

WIRE ROPE - 6X36, STEEL CORE, GALVANIZED

- Material: Extra Improved Plow Steel (Grade 1960)
 - Standard: ISO 2408, RR-W-410G, API-9A
 - Finish: Drawn Galvanized, Lube: Dry
 - Lay: ROL (sZ) / Core: IWRC
 - Construction: 6x36
 - Certification: Manufacturers (on request)
- *Actual loads may vary.



Diameter (in)	*MBF (lb)	Weight / ft (lb)	Qty. / Reel (ft)	Price / ft Full Reel Only	Price / ft	Part Number
1/4	6800	0.12	5000	0.89	1.07	WR-6X36-1/4"
5/16	10 540	0.18	5000	1.24	1.49	WR-6X36-5/16"
3/8	15 100	0.26	5000	1.53	1.84	WR-6X36-3/8"
7/16	20 400	0.35	5000	1.99	2.38	WR-6X36-7/16"
1/2	26 600	0.46	5000	2.52	3.02	WR-6X36-1/2"
5/8	41 200	0.72	5000	3.78	4.53	WR-6X36-5/8"
3/4	58 800	1.04	5000	5.30	6.35	WR-6X36-3/4"
7/8	79 600	1.42	2500	7.24	8.71	WR-6X36-7/8"
1	103 400	1.85	2500	9.30	11.06	WR-6X36-1"
1-1/8	130 000	2.34	2500	12.15	14.58	WR-6X36-11/8"
1-1/4	159 800	2.89	2500	14.81	17.78	WR-6X36-11/4"
1-3/8	192 000	3.50	2000, 3000	17.95	21.54	WR-6X36-1-3/8"
1-1/2	228 000	4.16	2500	20.86	25.03	WR-6X36-11/2"
1-3/4	306 000	5.67	2000	28.97	34.77	WR-6X36-1-3/4"
2	396 000	7.39	1500	39.12	46.94	WR-6X36-2"
2-1/4	494 000	9.36	1200	Stock items, call for pricing		WR-6X36-2-1/4"
2-1/2	604 000	11.6	1000			WR-6X36-2-1/2"
3	936 000	16.6	1000			WR-6X36-3"

WIRE ROPE - 8X26, BOOM ROPE, BRIGHT & GREASED

Improved Fatigue and Abrasion Resistance because of plastic filled between the steel core and the outer strands. FlexTec rope has excellent abrasion resistance and fatigue resistance by keeping out water and abrasive elements that could penetrate conventional ropes.

Improved service life for crane usage, because of the plastic filled in the FlexTec; it can absorb shock and reduce the peak loading of wire rope under high dynamic loadings. Two times service life can be achieved compared to conventional ropes.

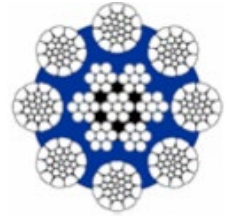

- Material: Extra Improved Plow Steel (Grade 1960)
 - Standard: ISO 2408, RR-W-410G, API-9A
 - Finish: Bright, Lube: A1 Light Lube
 - Lay: ROL (sZ) / Core: IWRC
 - Construction: 8x26
 - Certification: Manufacturers (on request)
 - Rated in Metric Ton(s)
 - Rotation - resistance
 - High structural stability
 - High breaking load
 - High Flexibility
 - Safe to shape-damage
 - Prevents abrasion and break among internal wires
 - Extended life of winch drum and sheave
 - Suitable for Tower Crane
 - Excellent life time
 - Extremely reduces internal stress
- *Actual loads may vary.

Diameter (mm)	*MBF (t)	Approx. Weight (kg/m)	Qty. / Reel (ft)	Price / ft	Part Number
16	23.0 (50 700 lb)	1.17 (0.78 lb / ft.)	5,000	9.62	WR-8X26-16MM

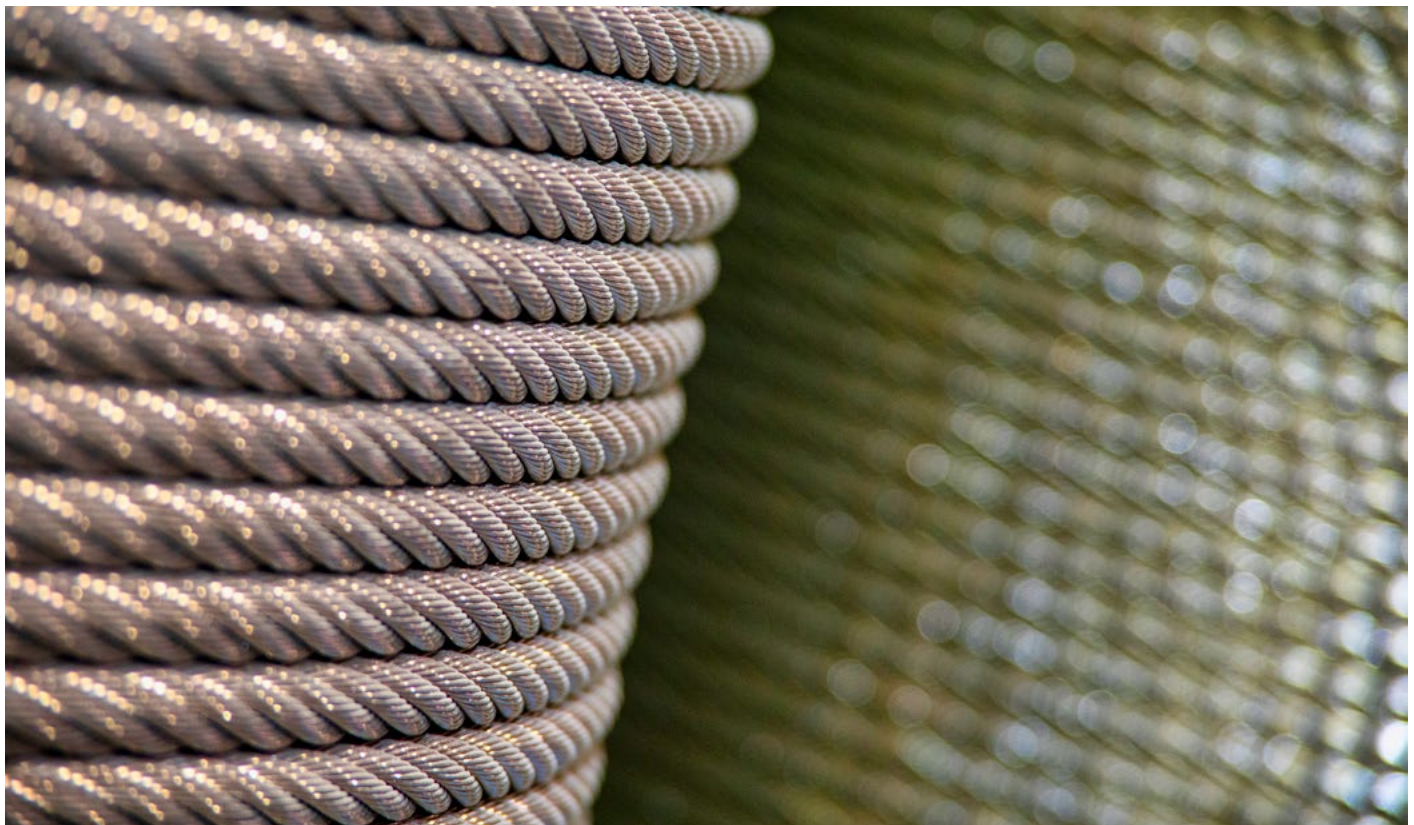

WIRE ROPE - 18X19S, ROTATION RESISTANT, STEEL CORE, BRIGHT & GREASED

- Material: Extra Improved Plow Steel (Grade 1960)
- Standard: ISO 2408, RR-W-410G, API-9A
- Finish: Bright, Lube: A1 Light Lube
- Lay: ROL (sZ) / Core: IWRC
- Construction: 18x19, Seale Construction
- Certification: Manufacturers (on request)
- *Actual loads may vary.

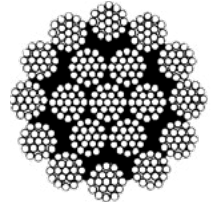

Diameter (in)	*MBF (lb)	Weight / ft (lb)	Price / ft	Part Number
9/16	27 200	0.70	3.65	WR-18X19-9/16"
5/8	33 600	0.86	4.42	WR-18X19-5/8"
3/4	48 000	1.24	6.13	WR-18X19-3/4"
7/8	65 000	1.69	8.18	WR-18X19-7/8"

WIRE ROPE - 19X7, ROTATION RESISTANT, STEEL CORE, BRIGHT & GREASED

- Material: Extra Improved Plow Steel (Grade 1960)
- Standard: ISO 2408, RR-W-410G, API-9A
- Finish: Bright, Lube: A1 Light Lube
- Lay: ROL (sZ) / Core: IWRC
- Construction: 19x7
- Certification: Manufacturers (on request)
- *Actual loads may vary.

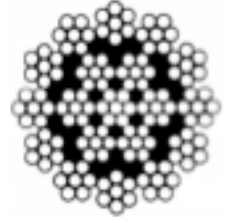

Diameter (in)	*MBF (lb)	Weight / ft (lb)	Price / ft	Part Number
1/4	5540	0.11	1.48	WR-19X7-1/4"
5/16	8600	0.18	1.84	WR-19X7-5/16"
3/8	12 300	0.25	1.98	WR-19X7-3/8"
7/16	16 660	0.35	2.60	WR-19X7-7/16"
1/2	21 600	0.45	3.35	WR-19X7-1/2"
9/16	27 200	0.58	4.05	WR-19X7-9/16"
5/8	33 600	0.71	4.94	WR-19X7-5/8"
3/4	48 000	1.02	6.97	WR-19X7-3/4"

WIRE ROPE - 6X25, TROLLEY & HOISTS ROPE, FIBER CORE, BRIGHT & GREASED

- Material: Improved Plow Steel (Grade 1770)
- Standard: ISO 2408, RR-W-410G, API-9A
- Finish: Bright, Lube: A1 Light Lube
- Lay: ROL (sZ) / Core: FC
- Construction: 6x25
- Certification: Manufacturers (on request)
- *Actual loads may vary.



Diameter (in)	*MBF (lb)	Approx. Weight / ft (lb)	Price / ft	Part Number
3/8	12 200	0.24	1.62	WR-6X25-3/8"
1/2	21 400	0.42	2.67	WR-6X25-1/2"
3/4	47 600	0.95	5.47	WR-6X25-3/4"
7/8	64 400	1.29	7.32	WR-6X25-7/8"

WIRE ROPE - 6X37, FIBER CORE, BRIGHT & GREASED

- Material: Improved Plow Steel (Grade 1770)
- Standard: ISO 2408, RR-W-410G, API-9A
- Finish: Bright, Lube: A1 Light Lube
- Lay: ROL (sZ) / Core: FC
- Construction: 6x37
- Certification: Manufacturers (on request)
- *Actual loads may vary.



Diameter (in)	*MBF (lb)	Weight / ft (lb)	Price / ft	Part Number
7/16	16 540	0.35	2.54	WR-6X37-7/16"
1/2	21 400	0.46	2.87	WR-6X37-1/2"
5/8	33 400	0.72	4.15	WR-6X37-5/8"

WIRE ROPE - 35X7, COMPACTED, HOIST ROPE, BRIGHT & GREASED

By flattening the surface of outer wires of each strand, this plane contacting lay construction has a flat touch area of outer wires comparing round strand type rope. This flat touch area enables longer life of each wire before breaking. While designing this construction, we emphasized the optimal balance between high tensile strength, fatigue resistance, and structural stability. These ropes are widely used in various applications such as crane, fishing and mining.

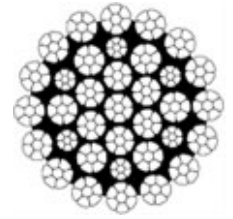

- Rotation - resistance
- Safe to shape-damage
- High structural stability
- Extended life of winch drum and sheave
- High breaking load
- Suitable for Tower Crane
- Strong against abrasion
- Excellent life time
- Material: Extra Improved Plow Steel (Grade 1960)
- Standard: ISO 2408, RR-W-410G, API-9A
- Finish: Bright, Lube: A1 Light Lube
- Lay: ROL (sZ) / Core: IWRC
- Construction: 35x7, Compacted
- Certification: Manufacturers (on request)
- Rated in Metric Ton(s)

*Actual loads may vary.

Diameter (mm)	*MBF (t)	Approx. Weight (kg/m)	Price / ft (> 1000 ft)	Price / ft (< 1000 ft)	Part Number
14	17.1 (37 770 lb)	0.974 (0.65 lb / ft)	6.26	7.22	WRI-35X7-14MM
15	20.4 (44 900 lb)	1.015 (0.68 lb / ft)	6.94	7.99	WRI-35X7-15MM
16	22.8 (50 360 lb)	1.272 (0.85 lb / ft)	7.62	8.77	WRI-35X7-16MM
18	27.9 (61 600 lb)	1.610 (1.08 lb / ft)	8.88	10.19	WRI-35X7-18MM
20	34.8 (76 660 lb)	1.988 (1.34 lb / ft)	10.53	12.09	WRI-35X7-20MM
22	42.3 (93 300 lb)	2.405 (1.62 lb / ft)	12.16	13.98	WRI-35X7-22MM
26	60.0 (132 190 lb)	3.360 (2.26 lb / ft)	16.32	18.76	WRI-35X7-26MM
28	68.9 (151 970 lb)	3.896 (2.62 lb / ft)	20.65	23.74	WRI-35X7-28MM

WIRE ROPE - 35X7, COMPACTED, HOIST ROPE, BRIGHT & GREASED

- Material: Extra Improved Plow Steel (Grade 2160)
- Standard: ISO 2408, RR-W-410G, API-9A
- Finish: Bright, Lube: A1 Light Lube
- Lay: RLL (zZ) / Core: IWRC
- Construction: 35x7, Compacted
- Certification: Manufacturers (on request)
- Rated in Metric Ton(s)

*Actual loads may vary.

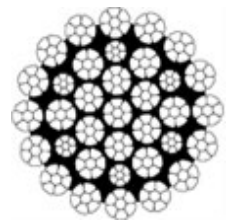

Diameter (mm)	*MBF (t)	Approx. Weight (kg/m)	Price / ft (> 1000 ft)	Price / ft (< 1000 ft)	Part Number
19	35.1 (77 330 lb)	1.86	11.00	12.67	WR-35X7-19MM2160

WIRE ROPE - 35X7, COMPACTED, HOIST ROPE, BRIGHT & GREASED

- Material: Extra Improved Plow Steel (Grade 1960)
- Standard: ISO 2408, RR-W-410G, API-9A
- Finish: Bright, Lube: A1 Light Lube
- Lay: RLL (zZ) / Core: IWRC
- Construction: 35xK7, Compacted
- Certification: Manufacturers (on Request)
- *Actual loads may vary.

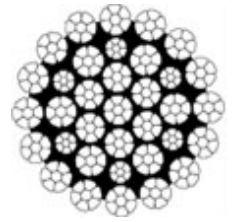

Diameter (in)	*MBF (lb)	Approx. Weight (lb/ft)	Price / ft (> 1000 ft)	Price / ft (< 1000 ft)	Part Number
1	124 800	2.26	16.08	18.49	WRI-35x7-1"

WIRE ROPE - 35X7, COMPACTED, NON-ROTATING, STEEL CORE, GALVANIZED & GREASED

- Material: Extra Improved Plow Steel (Grade 1960)
- Standard: ISO 2408, RR-W-410G, API-9A
- Finish: Drawn Galvanized, Lube: A1 Light Lube
- Lay: RLL (zZ) / Core: IWRC
- Construction: 35xK7, Compacted
- Certification: Manufacturers (on request)
- *Actual loads may vary.

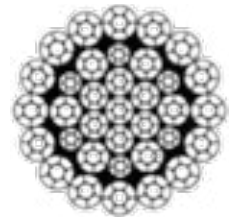

Diameter (mm)	*MBF (lb)	Weight / ft (lb)	Price / ft (> 1000 ft)	Price / ft (< 1000 ft)	Part Number
10	19 690	0.33	4.83	5.56	WRGI-35X7-10MM
12	27 880	0.48	5.32	6.09	WRGI-35X7-12MM
18	61 600	1.08	9.55	11.10	WRGI-35X7-18MM

WIRE ROPE - 35X7, COMPACTED, NON-ROTATING, STEEL CORE, GALVANIZED & GREASED

By flattening the surface of outer wires of each strand, this plane contacting lay construction has a flat touch area of outer wires comparing round strand type rope. This flat touch area enables longer life of each wire before breaking. While designing this construction, we emphasized the optimal balance between high tensile strength, fatigue resistance, and structural stability. These ropes are widely used in various applications such as crane, fishing and mining.

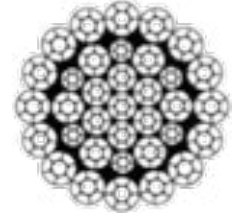

- Material: Extra Improved Plow Steel (Grade 2160)
- Standard: ISO 2408, RR-W-410G, API-9A
- Finish: Drawn Galvanized, Lube: A1 Light Lube
- Lay: RLL (zZ) / Core: IWRC
- Construction: 35xK7, Compacted
- Certification: Manufacturers (on request)

*Actual loads may vary.

Diameter (mm)	*MBF (lb)	Weight / ft (lb)	Price / ft (≥ 1000 ft)	Price / ft (< 1000 ft)	Part Number
10	22 100	0.35	5.38	6.20	WRG-35X7-10MM
12	31 470	0.50	5.93	6.80	WRG-35X7-12MM
13	36 420	0.56	6.60	7.58	WRG-35X7-13MM
14	42 260	0.65	7.35	8.43	WRG-35X7-14MM
15	49 600	0.75	8.37	9.61	WRG-35X7-15MM
16	56 430	0.89	9.36	10.76	WRG-35X7-16MM
18	69 240	1.08	11.61	13.35	WRG-35X7-18MM
19	77 330	1.25	12.92	14.85	WRG-35X7-19MM
20	85 900	1.34	14.16	16.28	WRG-35X7-20MM
22	104 800	1.62	17.18	19.75	WRG-35X7-22MM
24	124 770	1.92	20.44	23.50	WRG-35X7-24MM
26	148 400	2.26	24.00	27.59	WRG-35X7-26MM
28	170 400	2.62	27.79	31.95	WRG-35X7-28MM
30	198 400	3.05	31.94	36.72	WRG-35X7-30MM
32	220 300	3.42	36.32	41.76	WRG-35X7-32MM

WIRE ROPE - 8X19, SEALE, IWRC 1960 N/MM2, GALVANIZED, A-2 LUBE

- Material: Extra Improved Plow Steel (Grade 1960)
- Standard: ISO 2408, RR-W-410G, API-9A
- Finish: Drawn Galvanized, Lube: A2 Lube
- Lay: RRL and LRL / Core: IWRC
- Construction: 8x19
- Certification: Manufacturers (on request)
- *Actual loads may vary.

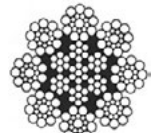

Diameter (mm)	*MBF (lb)	Weight / ft (lb)	Lay	Price / ft	Part Number
7	7688	0.16	RRL	1.53	WR-8X19-7MMRRL
7	7688	0.16	LRL	1.53	WR-8X19-7MMLRL
7.5	8813	0.18	RRL	1.85	WR-8X19-7.5MMRRL
8	10 049	0.20	RRL	1.92	WR-8X19-8MMRRL
8	10 049	0.20	LRL	1.92	WR-8X19-8MMLRL
9	12 701	0.24	RRL	2.37	WR-8X19-9MMRRL
9	12 701	0.24	LRL	2.37	WR-8X19-9MMLRL
10	15 691	0.31	RRL	3.02	WR-8X19-10MMRRL
10	15 691	0.31	LRL	3.02	WR-8X19-10MMLRL

WIRE ROPE - 8X36, SEALE, IWRC 1960 N/MM2, GALVANIZED, A-2 LUBE

- Material: Extra Improved Plow Steel (Grade 1960)
- Standard: ISO 2408, RR-W-410G, API-9A
- Finish: Drawn Galvanized, Lube: A2 Lube
- Lay: RRL and LRL / Core: IWRC
- Construction: 8x36
- Certification: Manufacturers (on request)
- *Actual loads may vary.

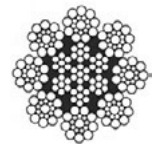

Diameter (mm)	*MBF (lb)	Weight / ft (lb)	Lay	Price / ft	Part Number
11	18 973	0.36	RRL	3.46	WR-8X36-11MMRRL
11	18 973	0.36	LRL	3.46	WR-8X36-11MMLRL
12	22 480	0.43	RRL	4.03	WR-8X36-12MMRRL
12	22 480	0.43	LRL	4.03	WR-8X36-12MMLRL
13	26 526	0.52	RRL	4.70	WR-8X36-13MMRRL
13	26 526	0.52	LRL	4.70	WR-8X36-13MMLRL
14	30 798	0.60	RRL	5.45	WR-8X36-14MMRRL
14	30 798	0.60	LRL	5.45	WR-8X36-14MMLRL
16	40 239	0.77	RRL	6.99	WR-8X36-16MMRRL
16	40 239	0.77	LRL	6.99	WR-8X36-16MMLRL
18	50 805	0.97	RRL	8.77	WR-8X36-18MMRRL
18	50 805	0.97	LRL	8.77	WR-8X36-18MMLRL
20	62 719	1.21	RRL	10.72	WR-8X36-20MMRRL
20	62 719	1.21	LRL	10.72	WR-8X36-20MMLRL



INDEX

FALL ARREST	154	Chain - Mid-Link Fishing, Grade 80.....	10
Hook - Rebar, N-3620.....	157	Chain - Overhead Lifting, Grade 80, Ocean® Brand.....	7
Hook - Rebar, N-3630.....	157	Chain - Overhead Lifting, Grade 100, Ocean® Brand	7
Hook - Snap, N-3610.....	157	Chain - Proof Coil, Grade 30	9
Link - Carabiner, Self-Locking, With Captive Pin, N-252g.....	155	Chain - Self Coloured, High Test, Grade 43.....	10
Link - Carabiner, Self-Locking, With Captive Pin, N-256g.....	156	Chain Slings - Sling Chart, Chain.....	12
Link - Carabiner, Self-Locking, With Captive Pin, N-259g.....	155	Chain - Stainless, Grade 50	12
Link - O-Ring, N-489	156	Chain - Transport, Grade 70, Ocean® Brand.....	8
HOISTS & LIFTING ACCESSORIES	127	MARINE.....	161
Available Spare Parts For Chain Hoist Block 619.....	133	Anchor - Ac-14.....	183
Block - Chain Hoist, 619, Ocean® Brand.....	129	Anchor - Danforth Style / Workboat.....	179
Block - Chain Hoist, 619, Ocean® Brand (Nop).....	130	Anchor - Dead Weights	187
Cable Sock - K-Type.....	152	Anchor - Delta Hhp.....	182
Cable Sock - T-Type.....	151	Anchor - Stockless.....	181
Chain Hoist Parts Breakdown	132	Anchor - St Offshore	186
Clamp - Beam.....	148	Anchor - Sts Offshore.....	187
Clamp - Plate, Horizontal Lifting Clamp.....	151	Aquaculture Gear Available From Stock.....	162
Drum Lifter.....	154	Bag - Bait.....	177
Lever Hoist Parts Breakdown	142	Bollard - Curved Type A.....	207
Lever Hoist - Puller, 622, Ocean® Brand.....	139	Bollard - Deck Mount Lxy-B012.....	209
Lever Hoist - Puller, 622, Ocean® Brand (Nop).....	141	Bollard - Dock Type J.....	207
Lever Hoist - Puller, 816, Ocean® Brand, Subsea.....	134	Bollard - Double Bit Deck Mount Lxy-B011	209
Lever Hoist - Puller, Hsh-Al, Ocean® Brand,		Bollard - Double Bitt Lxy-B09.....	208
Light Weight Aluminum.....	136	Bollard - Double Bitt Lxy-B10	208
Light Weight Aluminum Lever Hoist.....	136	Bollard - Single-Bite Type Jis.....	211
Non-Overload Protection.....	130	Bollard - Single Bitt	210
Non-Overload Protection.....	140	Bollard - T-Head.....	212
Pcd Vertical Plate Clamps Table	150	Bollard - Type Stag Horn	211
Permanent Magnet Lifter.....	145	Bracket - Smit Bracket.....	207
Permanent Magnet Lifter -		Chain - Open Link.....	165
Warnings and Application Instructions	146	Chain - Stud Link Anchor	165
Principle of Overload Protection.....	128, 138	Chock - Bulwark Mounting, Bow, Type Eu	205
Rope Grab - Puller	152	Chock - Bulwark Mounting, Jis F2017-Bc.....	204
Trolleys - Beam, Push Travel	147	Chock - Bulwark Mounting, Jis F2030-A.....	204
Winch - Wire Rope	144	Chock - Mounting, Type Eu.....	205
Winch - Wire Rope, Spare Pin.....	144	Cleat - Dock, Heavy Duty	175
		Container Lifting - Sea-Stab.....	214
 		Fairlead Roller - Anchor	201
LASHING EQUIPMENT	15	Fairlead Roller - Jis F2014.....	202
Buckle - Ratchet.....	22	Fairlead Roller - Type A.....	201
Hook - Wire, Double J.....	23	Fairlead Roller - Universal.....	202
Loadbinder - Folding Binder - Ratchet.....	18	Fender And Buoyancy.....	198
Loadbinder - Lever.....	16	Fender - Cylindrical Fenders.....	194
Loadbinder - Lever, Bx.....	16	Fender - Foam Filled Fender Type & Structure.....	196
Loadbinder - Ratchet.....	17	Fender Foam Ionomer, Berthing Energy And Reaction Forces.....	200
Loadbinder - Ratchet, Hs.....	17	Fender Foam Ionomer, Gilman Corporation.....	199
Loadbinder - Ratchet, T-Handle	19	Fender - Pneumatic Fender.....	195
Ring - Weld-On D-Ring Tie Down	20	Hinge - Butt, Heavy Duty.....	176
Tie Down Cargo Strap - Chain Assembly.....	19	Hinge - Strap.....	176
Tie Down Cargo Strap - Ratchet.....	21	Hook - Chain Grapnel.....	191
Webbing - Tie Down Material, Polyester.....	23	Hook - Dual Chaser Ring.....	193
Winch - Truck, #5820.....	20	Hook - G, Alloy, Grade 80 / Link - Recessed, Alloy, Grade 80.....	172
		Hook - J, Chain Chaser.....	191
 		Hook - Pelican Sliphook, GN®.....	190
LIFTING & GENERAL PURPOSE CHAIN.....	6	Hook - Permanent Chain Chaser.....	192
Chain - Alloy Long-Link, Grade 80, Ocean® Brand.....	8	Hook - Ring Chaser.....	193
Chain - Alloy Long-Link, Grade 80, Trygg®.....	11	Jar - Bait	178
Chain - Alloy Short-Link, Grade 80, Trygg®.....	11		
Chain - Long-Link Lashing, Grade 80.....	11		

INDEX

Knife - Bait	177
Knife - Scallop.....	177
Link - Connecting, Pear, Anchor Joining	170
Link - Split	172
Link - Split, Alloy, Lobster Link	173
Mooring Connector - H-Links	213
Oar Lock.....	176
Ring - Round	169
Shackle - Kenter Shackle, Joining Link	168
Sheave - Horizontal Lead.....	205
Sheave - Vertical Lead	205
Stenhouse Slip.....	178
Stopper - Chain Cable Stopper.....	206
Swivel - Forerunner, Assembly, With Links.....	163
Swivel - Lobster	174
Triangle Plate - GN®	172
Tuning Fork - GN®	189
Turnbuckle - Chain Stopper Assembly, Devil's Claw	168
Washer - Scallop, Black.....	178

OCEAN G80 & G100 STEEL LIFTING COMPONENTS..... 24

Hook - Clevis Grab Hook, Grade 80, Ocean® Brand	26
Hook - Clevis Grab Hook, Grade 100, Ocean® Brand.....	36
Hook - Clevis Grab Hook With Pin, Grade 100, Ocean® Brand.....	37
Hook - Clevis Sling Hook, Grade 80, Ocean® Brand.....	27
Hook - Clevis Sling Hook, Grade 100, Ocean® Brand.....	37
Hook - Container Hook, Grade 80, Ocean® Brand.....	30
Hook - Coupling, Self-Locking, Grade 80, Ocean® Brand	34
Hook - Eye Sling Hooks, Grade 100, Ocean® Brand	40
Hook - Foundry Clevis Hooks, Grade 100, Ocean® Brand.....	40
Hook - Foundry Eye Hook, Grade 80, Ocean® Brand.....	29
Hook - Foundry Eye Hooks, Grade 100, Ocean® Brand.....	40
Hook - Kit, Clevis, Load Pin Kit, Grade 80, Ocean® Brand	31
Hook - Kit, Clevis, Load Pin Kit, Grade 100, Ocean® Brand.....	42
Hook - Kit, Self-Locking Recessed Trigger Kit, Grade 80/100, Ocean® Brand	31, 41
Hook - Self Locking Clevis Hook, Grade 80, Ocean® Brand.....	29
Hook - Self Locking Clevis Hook, Grade 100, Ocean® Brand	39
Hook - Self Locking Eye Hook, Grade 80, Ocean® Brand.....	28
Hook - Self Locking Eye Hook, Grade 100, Ocean® Brand	39
Hook - Self Locking Swivel Hook, Grade 80, Ocean® Brand	28
Hook - Sliding Choker Hooks, Grade 80, Ocean® Brand	30
Hook - Swivel Self Locking Hook Ball Bearing, Grade 100, Ocean® Brand	38
Hook - Swivel Self Locking Hook Brass Bushing, Grade 100, Ocean® Brand	38
Hook - Web And Round Sling Hook, Grade 100, Ocean® Brand	41
Hook - Weld On Bucket Hook, Grade 80, Ocean® Brand.....	43
Link - Connecting Link, Grade 80, Ocean® Brand.....	26
Link - Connecting Link, Grade 100, Ocean® Brand	36
Link - Coupling, Half Link & Pin, Grade 80, Ocean® Brand.....	32
Link - Coupling, Master Link, Grade 80, Ocean® Brand.....	34
Link - Coupling & Pin, Grade 80, Ocean® Brand	33
Link - Coupling, Round Sling, Grade 80, Ocean® Brand	32
Link - Kit, Connecting, Pin & Sleeve Kit, Grade 80, For Ocean® Brand Coupling Series.....	34
Link - Kit, Connecting, Pin & Sleeve Kit, Grade 80, Ocean® Brand.....	31

Link - Kit, Connecting, Pin & Sleeve Kit, Grade 100, Ocean® Brand	42
Link - Master Link, Grade 80, Ocean® Brand.....	25
Link - Master Link, Grade 100, Ocean® Brand.....	35
Ring - Weld On Lifting Point, Grade 80, Ocean® Brand.....	44
Swivel - Coupling, Insulated Blank Swivel, Grade 80, Ocean® Brand.....	33
Swivel - Hoist Ring, Metric Thread, Grade 80, Ocean® Brand	50
Swivel - Hoist Ring, Unc Thread (Ocean), Grade 80.....	49,51
Swivel - Hoist Ring, Unc Thread, Grade 80, Ocean® Brand	48
Swivel - Lifting Eye Key Point, Metric Thread, Grade 80, Ocean® Brand.....	47
Swivel - Lifting Eye Key Point - Unc Thread, Grade 80, Ocean® Brand.....	46

RIGGING HARDWARE & EQUIPMENT..... 52

Block - Chain.....	102
Block - Gin.....	102
Block - Pulley.....	104
Block - Sheave Bronze Brushed.....	103
Block - Single Or Double Sheave, Wooden, With Hook.....	103
Block - Snatch, Double Sheave, Light Duty, With Hook, Ocean® Brand.....	105
Block - Snatch, Double Sheave, Light Duty, With Shackle, Ocean® Brand	106
Block - Snatch, Single Sheave, Alloy, With Hook, Ocean® Brand	106
Block - Snatch, Single Sheave, Alloy, With Shackle, Ocean® Brand	107
Block - Snatch, Single Sheave, Heavy Duty, With Eye, GN®	111
Block - Snatch, Single Sheave, Large, Super Duty, With Hook, Ocean® Brand	109
Block - Snatch, Single Sheave, Large, Super Duty, With Shackle, Ocean® Brand	110
Block - Snatch, Single Sheave, Light Duty, Tail Board, Ocean® Brand.....	105
Block - Snatch, Single Sheave, Light Duty, With Hook, Ocean® Brand	107
Block - Snatch, Single Sheave, Light Duty, With Shackle, Ocean® Brand	108
Block - Snatch, Single Sheave, With Hook, Ocean® Brand	108
Block - Snatch, Single Sheave, With Shackle, Ocean® Brand.....	109
Block - Snatch, Single Sheave, Wooden, With Hook.....	104
Block - Try Net	101
Block - Yarding.....	101
Bow, Anchor, With Safety Bolt Green Pin®	64
Bow, Anchor, With Safety Bolt Yellow Pin®	58
Bow, Anchor, With Screw Green Pin®.....	63
Bow, Anchor, With Screw Pin.....	55
Bow, Anchor, With Screw Yellow Pin®	57
Bow, With Safety Bolt, GN®	62
Commercial Bow, Anchor, With Screw Pin.....	54
Dee (Chain) Trawling, With Square Head Screw Pin.....	52
Dee (Chain), With Screw Pin.....	53
Eye Bolt - Regular With Nut.....	80
Eye Bolt - Ring With Shoulder & Nut.....	84
Eye Bolt - Screw.....	81
Eye Bolts Forged - Warnings And Application Instructions.....	87

INDEX

Eye Bolt - Shoulder Machine, Imperial.....	84	Turnbuckle - Jaw & Jaw, Stainless Steel.....	76
Eye Bolt - Shoulder Machine, Metric.....	85	Turnbuckle - Stub End.....	77
Eye Bolt - Shoulder With Nut.....	82, 83	Turnbuckle - Stub End, Body Only.....	77
Eye Bolt - Shoulder With Nut, Unc.....	81	Water Bags, Crane.....	114
Eye Nut.....	83, 86	Water Bags, Crane Certification Fluid Weight.....	113
Eye Pad.....	85	Water Bags, Lifeboat.....	114
Hook - Anchor Line Hook, GN®.....	124	Wide Body Sling, With Safety Bolt Green Pin®.....	59
Hook - Carabiner, Fishing, Screw Lock.....	93	Wide Body Sling, With Safety Bolt, Yoke® Brand.....	59
Hook - Clevis, Grab, Grade 70.....	117	Wide Mouth Bow, With Safety Bolt Green Pin®.....	66
Hook - Clevis, Grab, With Latch, Grade 70.....	117		
Hook - Clevis, Slip, Grade 70.....	118	ROPE (SYNTHETIC & FIBER).....	232
Hook - Clevis, Slip, With Latch, Grade 70.....	118	Fid - Norwegian.....	251
Hook - Eye, Hoist, Grade 100, Yoke® Brand.....	124	Rope - Dsm Dyneema, 8 & 12-Strand.....	235
Hook - Eye, Hoist, With Latch.....	119	Rope - Dsm Dyneema, 12-Strand.....	236
Hook - Eye, Rov, With Latch, GN®.....	122	Rope - Manila, 3-Strand.....	233
Hook - Eye, Slip, With Latch.....	116	Rope - Manila, 4-Strand.....	242
Hook - Lanyard, With Double Lock.....	117	Rope - Nylon, 3-Strand.....	244
Hook - Latch Kit.....	121	Rope - Nylon, 8-Strand.....	243
Hook - Rov Shank Hook, GN®.....	123	Rope - Nylon Double Braided 2-1, Ocean Steel Line.....	247
Hook - "S".....	93	Rope - Nylon, Jumbo, 3-Strand.....	245
Hooks Eye Hoist - Warnings And Application Instructions.....	126	Rope - Ocean Steel Line, 3-Strand, Aqua.....	240
Hook - Snap.....	93	Rope - Ocean Steel Line, 3-Strand, Yellow.....	241
Hook - Snap, With Latch.....	115	Rope - Ocean Steel Line, 8-Strand, Gold.....	241
Hook - Sorting, With Handle.....	115	Rope - Polyester Double Braided 2-1, Ocean Steel Line.....	248
Hook - Swivel Eye, Hoist, With Latch.....	120	Rope - Polypropylene, Jumbo, 3-Strand, Yellow.....	242
Hook - Swivel Eye, With Latch.....	116	Rope - Sail Twine, Waxed.....	242
Hook - Swivel, Hoist, Grade 100, Yoke® Brand.....	124	Rope - Sash Cord, Cotton.....	246
Link - Master Link, Dnv 2.7-1+.....	88	Rope Types - Synthetic.....	247
Link - Quick.....	92	Sail Needle.....	251
Link - Twin Clevis.....	92	Sail Palms.....	252
Load Cell - Software Packages.....	116	Slings - Sling Chart, Dyneema (Synthetic Rope), Endless Grommet.....	238
Load Cell - Wireless Kit.....	114	Slings - Sling Chart, Dyneema (Synthetic Rope), Eye & Eye.....	237
Master Link Assembly, Dnv 2.7-1+.....	89	Soft Shackles.....	239
Master Link, Large.....	91	Splicing - Pusher & Fids - Aluminum.....	252
Pear, Weldless Sling.....	90	Twin-path Extra Covermax.....	230
Ring - Round, Weldless.....	91		
Rov Locking Clamp Release Bow, Polar, With Green Pin®.....	68	SLINGS.....	218
Rov Spring Release Bow, Polar, With Green Pin®.....	67	Sling - Round, Polyester.....	229, 230, 231
Shackle - Warnings And Applications.....	69	Sling - Webbing Material, Polyester.....	230
Sling Protector, With Safety Bolt, GN®.....	60	Sling - Web, Polyester.....	228, 229
Super Bow, Anchor, With Safety Bolt Green Pin®.....	65	Sling - Wire Rope, Bright, With A1 Light Lube.....	219, 220
Swivel - Bullet Style, Angular Contact Bearing.....	99	Sling - Wire Rope, Galvanized.....	221-223
Swivel - Closed Body Swivel, GN®.....	100	Wire Rope Sling Charts.....	224
Swivel - Eye & Eye.....	94, 96		
Swivel - Eye & Eye, Angular Contact Bearing.....	97	TOOLS.....	157
Swivel - Eye & Eye, With Hardened Wearing Ring.....	96	Tool - Bolt Cutter.....	159
Swivel - Flex, Eye & Eye.....	97	Tool - Swager Cutter.....	158
Swivel - Jaw & Eye.....	95	Tool - Wire Cutter.....	158
Swivel - Jaw & Jaw, Angular Contact Bearing.....	99		
Swivel - Short Bow.....	96	WIRE ROPE.....	288
Turnbuckle - Bottle Type (Closed) Galvanized.....	75	Jiangsu Langshan Wire Rope Co. Ltd.....	
Turnbuckle - Eye & Eye, Galvanized.....	72	The Worlds Largest Wire Rope Factory.....	291
Turnbuckle - Eye & Eye, Lashing.....	76	Oceanside Equipment Ltd, Exclusive Canadian Dealer for Jiangsu Langshan Wire Rope Co. Ltd., The Worlds Largest Wire Rope Factory.....	290
Turnbuckle - Heavy Duty, GN®.....	78	Sea Lube Wire Rope Lubricant.....	289
Turnbuckle - Hook & Hook, Galvanized.....	73	Wire Rope - 6x19, Bridle Wire, Fiber Core, Galvanized.....	296
Turnbuckle - Jaw & Eye, Galvanized.....	74		
Turnbuckle - Jaw & Jaw, Bottle Type (Closed) Stainless Steel.....	75		
Turnbuckle - Jaw & Jaw, Galvanized.....	70		

INDEX

Wire Rope - 6x19, Steel Core, Galvanized	298	Sleeve (Ferrule) - Copper Oval.....	264
Wire Rope - 6x19, Steel Core, Galvanized & Greased.....	298	Sleeve (Ferrule) - Copper Stop	262
Wire Rope - 6x19, Trawl Warp, Fiber Core, Galvanized & Greased	296	Sleeve (Ferrule) - Duplex Oval	265
Wire Rope - 6x24, Fiber Core, Galvanized.....	297	Sleeve (Ferrule) - Flemish Splice, Carbon Steel	260
Wire Rope - 6x25, Trolley & Hoists Rope, Fiber Core, Bright & Greased	305	Sleeve (Ferrule) - Stainless Steel Duplex.....	265
Wire Rope - 6x26, Regular Swaged Ws, Steel Core, Bright & Greased.....	297	Sleeves (Ferrules) Size Number Table A.2	261
Wire Rope - 6x26, Steel Core, Bright & Greased.....	299	Socket - Clipinator Wedge Socket.....	286
Wire Rope - 6x26, Steel Core, Galvanized	301	Socketing Putty	282
Wire Rope - 6x36, Steel Core, Bright & Greased.....	300	Socket Lock - Resin	282
Wire Rope - 6x36, Steel Core, Galvanized.....	302	Socket - Spelter, Closed, Forged, Ocean.....	277
Wire Rope - 6x36, Steel Core, Galvanized & Greased.....	299	Socket - Spelter, Closed, GN®.....	280
Wire Rope - 6x37, Fiber Core, Bright & Greased.....	304	Socket - Spelter, Cr, Closed (Peewee, Gold Nose), GN®.....	281
Wire Rope - 7x7, 7x19, 6x19, 6x26, Steel Core, Stainless.....	294	Socket - Spelter, Open, Forged, Ocean	277
Wire Rope - 7x7 & 7x19, Aircraft Cable, Pvc Coated, Steel Core, Galvanized	293	Socket - Spelter, Open, GN®.....	278, 279
Wire Rope - 7x7, 7x19, Aircraft Cable, Pvc Coated, Steel Core, Stainless.....	295	Socket - Swage, Closed, Forged.....	284
Wire Rope - 7x7 & 7x19, Aircraft Cable, Steel Core, Galvanized	292	Socket - Swage, Open, Forged	285
Wire Rope - 8x19, Seale, Iwrc 1960 N/Mm2, Galvanized, A-2 Lube.....	309	Solid Thimble - Din 3091.....	271
Wire Rope - 8x26, Boom Rope, Bright & Greased.....	303	Swaging Machine New-Tech "Smart Press"	260
Wire Rope - 8x36, Seale, Iwrc 1960 N/Mm2, Galvanized, A-2 Lube.....	309	Swaging Machines From 150 Te To 4,000 Te	258
Wire Rope - 18x19s, Rotation Resistant, Steel Core, Bright & Greased.....	304	Thimble - Heavy Duty	267, 269
Wire Rope - 19x7, Rotation Resistant, Steel Core, Bright & Greased.....	304	Thimble - Light Duty.....	268, 269
Wire Rope - 35x7, Compacted, Hoist Rope, Bright & Greased.....	306, 307	Thimble - Synthetic Rope.....	271
Wire Rope - 35x7, Compacted, Non-Rotating, Steel Core, Galvanized & Greased.....	308	Thimble - Tube	270
Wire Rope - 35x7, Compacted, Non-Rotating, Steel Core, Galvanized & Greased.....	307	Wedge Socket Warnings And Use.....	287
WIRE ROPE END TERMINATORS	253	Wire Rope Broom Degreaser	282
Cable Joiner - Self-Locking.....	273		
Choker Button.....	272		
Clips Wire Rope 'Ocean' - Warnings and Application Instructions.....	276		
Clip - Wire Rope, Forged	275		
Clip - Wire Rope, Malleable	274		
Clip - Wire Rope, Stainless	274		
Die Lube - Swaging Lubricant.....	259		
Fast Flemish Swage System.....	255		
Go-No-Go Gauges - For Flemish Eye Steel Sleeves (Ferrules).....	272		
Hook - Micro Midget Choker	272		
Marlin Spike	266		
Reeling Machines Wirop Shaftless.....	265		
Resin Socketing Warning And Safety Information	285		
Rigging Equipment.....	254		
Sleeve (Ferrule) - Aluminium	262		
Sleeve (Ferrule) - Aluminium Duplex.....	263		
Sleeve (Ferrule) - Aluminium Stop	263		
Sleeve (Ferrule) - Button Stop.....	270		



INDEX A - Z

Anchor - Ac-14.....	183	Fender Foam Ionomer, Gilman Corporation.....	199
Anchor - Danforth Style / Workboat.....	179	Hinge - Butt, Heavy Duty.....	176
Anchor - Dead Weights.....	187	Hinge - Strap.....	176
Anchor - Delta Hhp.....	182	Hook - Chain Grapnel.....	191
Anchor - Stockless.....	181	Hook - Dual Chaser Ring.....	193
Anchor - St Offshore.....	186	Hook - G, Alloy, Grade 80 / Link - Recessed, Alloy, Grade 80.....	172
Anchor - Sts Offshore.....	187	Hook - J, Chain Chaser.....	191
Aquaculture Gear Available From Stock.....	162	Hook - Pelican Sliphook, GN®.....	190
Available Spare Parts For Chain Hoist Block 619.....	133	Hook - Permanent Chain Chaser.....	192
Bag - Bait.....	177	Hook - Rebar, N-3620.....	157
Block - Chain Hoist, 619, Ocean® Brand (Nop).....	130	Hook - Rebar, N-3630.....	157
Block - Chain Hoist, 619, Ocean® Brand.....	129	Hook - Ring Chaser.....	193
Bollard - Curved Type A.....	207	Hook - Snap, N-3610.....	157
Bollard - Deck Mount Lxy-B012.....	209	Hook - Wire, Double J.....	23
Bollard - Dock Type J.....	207	Jar - Bait.....	178
Bollard - Double Bit Deck Mount Lxy-B011.....	209	Knife - Bait.....	177
Bollard - Double Bitt Lxy-B09.....	208	Knife - Scallop.....	177
Bollard - Double Bitt Lxy-B10.....	208	Lever Hoist - Puller, 622, Ocean® Brand (Nop).....	141
Bollard - Single-Bite Type Jis.....	211	Lever Hoist - Puller, 622, Ocean® Brand.....	139
Bollard - Single Bitt.....	210	Lever Hoist - Puller, 816, Ocean® Brand, Subsea.....	134
Bollard - T-Head.....	212	Lever Hoist - Puller, Hsh-AI, Ocean® Brand, Lever Hoist Parts Breakdown.....	142
Bollard - Type Stag Horn.....	211	Light Weight Aluminum.....	136
Bracket - Smit Bracket.....	207	Light Weight Aluminum Lever Hoist.....	136
Buckle - Ratchet.....	22	Link - Carabiner, Self-Locking, With Captive Pin, N-252g.....	155
Cable Sock - K-Type.....	152	Link - Carabiner, Self-Locking, With Captive Pin, N-256g.....	156
Cable Sock - T-Type.....	151	Link - Carabiner, Self-Locking, With Captive Pin, N-259g.....	155
Chain - Alloy Long-Link, Grade 80, Ocean® Brand.....	8	Link - Connecting, Pear, Anchor Joining.....	170
Chain - Alloy Long-Link, Grade 80, Trygg®.....	11	Link - O-Ring, N-489.....	156
Chain - Alloy Short-Link, Grade 80, Trygg®.....	11	Link - Split, Alloy, Lobster Link.....	173
Chain - Long-Link Lashing, Grade 80.....	11	Link - Split.....	172
Chain - Mid-Link Fishing, Grade 80.....	10	Loadbinder - Folding Binder - Ratchet.....	18
Chain - Open Link.....	165	Loadbinder - Lever, Bx.....	16
Chain - Overhead Lifting, Grade 100, Ocean® Brand.....	7	Loadbinder - Lever.....	16
Chain - Proof Coil, Grade 30.....	9	Loadbinder - Ratchet, Hs.....	17
Chain - Self Coloured, High Test, Grade 43.....	10	Loadbinder - Ratchet, T-Handle.....	19
Chain - Stainless, Grade 50.....	12	Loadbinder - Ratchet.....	17
Chain - Stud Link Anchor.....	165	Mooring Connector - H-Links.....	213
Chain - Transport, Grade 70, Ocean® Brand.....	8	Non-Overload Protection.....	130
Chain - Overhead Lifting, Grade 80, Ocean® Brand.....	7	Non-Overload Protection.....	140
Chain Hoist Parts Breakdown.....	132	Oar Lock.....	176
Chain Slings - Sling Chart, Chain.....	12	Pcd Vertical Plate Clamps Table.....	150
Chock - Bulwark Mounting, Bow, Type Eu.....	205	Permanent Magnet Lifter - Permanent Magnet Lifter.....	145
Chock - Bulwark Mounting, Jis F2017-Bc.....	204	Principle of Overload Protection.....	128, 138
Chock - Bulwark Mounting, Jis F2030-A.....	204	Ring - Round.....	169
Chock - Mounting, Type Eu.....	205	Ring - Weld-On D-Ring Tie Down.....	20
Clamp - Beam.....	148	Rope Grab - Puller.....	152
Clamp - Plate, Horizontal Lifting Clamp.....	151	Shackle - Kenter Shackle, Joining Link.....	168
Cleat - Dock, Heavy Duty.....	175	Sheave - Horizontal Lead.....	205
Container Lifting - Sea-Stab.....	214	Sheave - Vertical Lead.....	205
Drum Lifter.....	154	Tie Down Cargo Strap - Chain Assembly.....	19
Fairlead Roller - Anchor.....	201	Tie Down Cargo Strap - Ratchet.....	21
Fairlead Roller - Jis F2014.....	202	Trolleys - Beam, Push Travel.....	147
Fairlead Roller - Type A.....	201	Warnings and Application Instructions.....	146
Fairlead Roller - Universal.....	202	Webbing - Tie Down Material, Polyester.....	23
Fender - Cylindrical Fenders.....	194	Winch - Truck, #5820.....	20
Fender - Foam Filled Fender Type & Structure.....	196	Winch - Wire Rope, Spare Pin.....	144
Fender - Pneumatic Fender.....	195	Winch - Wire Rope.....	144
Fender And Buoyancy.....	198		
Fender Foam Ionomer, Berthing Energy And Reaction Forces.....	200		

INDEX A - Z

Stenhouse Slip.....	178	Block - Chain.....	102
Stopper - Chain Cable Stopper.....	206	Block - Gin.....	102
Swivel - Forerunner, Assembly, With Links.....	163	Block - Pulley.....	104
Swivel - Lobster.....	174	Block - Sheave Bronze Brushed.....	103
Triangle Plate - GN®.....	172	Block - Single Or Double Sheave, Wooden, With Hook.....	103
Tuning Fork - GN®.....	189	Block - Snatch, Double Sheave, Light Duty, With Hook, Ocean® Brand.....	105
Turnbuckle - Chain Stopper Assembly, Devil's Claw.....	168	Block - Snatch, Double Sheave, Light Duty, With Shackle, Ocean® Brand.....	106
Washer - Scallop, Black.....	178	Block - Snatch, Single Sheave, Alloy, With Hook, Ocean® Brand.....	106
Hook - Clevis Grab Hook, Grade 80, Ocean® Brand.....	26	Block - Snatch, Single Sheave, Alloy, With Shackle, Ocean® Brand.....	107
Hook - Clevis Grab Hook, Grade 100, Ocean® Brand.....	36	Block - Snatch, Single Sheave, Heavy Duty, With Eye, GN®.....	111
Hook - Clevis Grab Hook With Pin, Grade 100, Ocean® Brand.....	37	Block - Snatch, Single Sheave, Large, Super Duty, With Hook, Ocean® Brand.....	109
Hook - Clevis Sling Hook, Grade 80, Ocean® Brand.....	27	Block - Snatch, Single Sheave, Large, Super Duty, With Shackle, Ocean® Brand.....	110
Hook - Clevis Sling Hook, Grade 100, Ocean® Brand.....	37	Block - Snatch, Single Sheave, Light Duty, Tail Board, Ocean® Brand.....	105
Hook - Container Hook, Grade 80, Ocean® Brand.....	30	Block - Snatch, Single Sheave, Light Duty, With Hook, Ocean® Brand.....	107
Hook - Coupling, Self-Locking, Grade 80, Ocean® Brand.....	34	Block - Snatch, Single Sheave, Light Duty, With Shackle, Ocean® Brand.....	108
Hook - Eye Sling Hooks, Grade 100, Ocean® Brand.....	40	Block - Snatch, Single Sheave, With Hook, Ocean® Brand.....	108
Hook - Foundry Clevis Hooks, Grade 100, Ocean® Brand.....	40	Block - Snatch, Single Sheave, With Shackle, Ocean® Brand.....	109
Hook - Foundry Eye Hook, Grade 80, Ocean® Brand.....	29	Block - Snatch, Single Sheave, Wooden, With Hook.....	104
Hook - Foundry Eye Hooks, Grade 100, Ocean® Brand.....	40	Block - Try Net.....	101
Hook - Kit, Clevis, Load Pin Kit, Grade 80, Ocean® Brand.....	31	Block - Yarding.....	101
Hook - Kit, Clevis, Load Pin Kit, Grade 100, Ocean® Brand.....	42	Bow, Anchor, With Safety Bolt Green Pin®.....	64
Hook - Kit, Self-Locking Recessed Trigger Kit, Grade 80/100, Ocean® Brand.....	31, 41	Bow, Anchor, With Safety Bolt Yellow Pin®.....	58
Hook - Self Locking Clevis Hook, Grade 80, Ocean® Brand.....	29	Bow, Anchor, With Screw Green Pin®.....	63
Hook - Self Locking Clevis Hook, Grade 100, Ocean® Brand.....	39	Bow, Anchor, With Screw Pin.....	55
Hook - Self Locking Eye Hook, Grade 80, Ocean® Brand.....	28	Bow, Anchor, With Screw Yellow Pin®.....	57
Hook - Self Locking Eye Hook, Grade 100, Ocean® Brand.....	39	Bow, With Safety Bolt, GN®.....	62
Hook - Self Locking Swivel Hook, Grade 80, Ocean® Brand.....	28	Commercial Bow, Anchor, With Screw Pin.....	54
Hook - Sliding Choker Hooks, Grade 80, Ocean® Brand.....	30	Dee (Chain) Trawling, With Square Head Screw Pin.....	52
Hook - Swivel Self Locking Hook Ball Bearing, Grade 100, Ocean® Brand.....	38	Dee (Chain), With Screw Pin.....	53
Hook - Swivel Self Locking Hook Brass Bushing, Grade 100, Ocean® Brand.....	38	Eye Bolt - Regular With Nut.....	80
Hook - Web And Round Sling Hook, Grade 100, Ocean® Brand.....	41	Eye Bolt - Ring With Shoulder & Nut.....	84
Hook - Weld On Bucket Hook, Grade 80, Ocean® Brand.....	43	Eye Bolt - Screw.....	81
Link - Connecting Link, Grade 80, Ocean® Brand.....	26	Eye Bolts Forged - Warnings And Application Instructions.....	87
Link - Connecting Link, Grade 100, Ocean® Brand.....	36	Eye Bolt - Shoulder Machine, Imperial.....	84
Link - Coupling, Half Link & Pin, Grade 80, Ocean® Brand.....	32	Eye Bolt - Shoulder Machine, Metric.....	85
Link - Coupling, Master Link, Grade 80, Ocean® Brand.....	34	Eye Bolt - Shoulder With Nut.....	82, 83
Link - Coupling & Pin, Grade 80, Ocean® Brand.....	33	Eye Bolt - Shoulder With Nut, Unc.....	81
Link - Coupling, Round Sling, Grade 80, Ocean® Brand.....	32	Eye Nut.....	83, 86
Link - Kit, Connecting, Pin & Sleeve Kit, Grade 80, For Ocean® Brand Coupling Series.....	34	Eye Pad.....	85
Link - Kit, Connecting, Pin & Sleeve Kit, Grade 80, Ocean® Brand.....	31	Hook - Anchor Line Hook, GN®.....	124
Link - Kit, Connecting, Pin & Sleeve Kit, Grade 100, Ocean® Brand.....	42	Hook - Carabiner, Fishing, Screw Lock.....	93
Link - Master Link, Grade 80, Ocean® Brand.....	25	Hook - Clevis, Grab, Grade 70.....	117
Link - Master Link, Grade 100, Ocean® Brand.....	35	Hook - Clevis, Grab, With Latch, Grade 70.....	117
Ring - Weld On Lifting Point, Grade 80, Ocean® Brand.....	44	Hook - Clevis, Slip, Grade 70.....	118
Swivel - Coupling, Insulated Blank Swivel, Grade 80, Ocean® Brand.....	33	Hook - Clevis, Slip, With Latch, Grade 70.....	118
Swivel - Hoist Ring, Metric Thread, Grade 80, Ocean® Brand.....	50	Hook - Eye, Hoist, Grade 100, Yoke® Brand.....	124
Swivel - Hoist Ring, Unc Thread (Ocean), Grade 80.....	49, 51	Hook - Eye, Hoist, With Latch.....	119
Swivel - Hoist Ring, Unc Thread, Grade 80, Ocean® Brand.....	48	Hook - Eye, Rov, With Latch, GN®.....	122
Swivel - Lifting Eye Key Point, Metric Thread, Grade 80, Ocean® Brand.....	47	Hook - Eye, Slip, With Latch.....	116
Swivel - Lifting Eye Key Point - Unc Thread, Grade 80, Ocean® Brand.....	46	Hook - Lanyard, With Double Lock.....	117

INDEX A - Z

Hook - Latch Kit.....	121	Rope - Ocean Steel Line, 3-Strand, Aqua.....	240
Hook - Rov Shank Hook, GN®.....	123	Rope - Ocean Steel Line, 3-Strand, Yellow.....	241
Hook - "S".....	93	Rope - Ocean Steel Line, 8-Strand, Gold.....	241
Hooks Eye Hoist - Warnings And Application Instructions.....	126	Rope - Polyester Double Braided 2-1, Ocean Steel Line.....	248
Hook - Snap.....	93	Rope - Polypropylene, Jumbo, 3-Strand, Yellow.....	242
Hook - Snap, With Latch.....	115	Rope - Sail Twine, Waxed.....	242
Hook - Sorting, With Handle.....	115	Rope - Sash Cord, Cotton.....	246
Hook - Swivel Eye, Hoist, With Latch.....	120	Rope Types - Synthetic.....	247
Hook - Swivel Eye, With Latch.....	116	Sail Needle.....	251
Hook - Swivel, Hoist, Grade 100, Yoke® Brand.....	124	Sail Palms.....	252
Link - Master Link, Dnv 2.7-1+.....	88	Slings - Sling Chart, Dyneema (Synthetic Rope), Endless Grommet.....	238
Link - Quick.....	92	Slings - Sling Chart, Dyneema (Synthetic Rope), Eye & Eye.....	237
Link - Twin Clevis.....	92	Soft Shackles.....	239
Load Cell - Software Packages.....	116	Splicing - Pusher & Fids - Aluminum.....	252
Load Cell - Wireless Kit.....	114	Twin-path Extra Covermax.....	230
Master Link Assembly, Dnv 2.7-1+.....	89	Sling - Round, Polyester.....	229, 230, 231
Master Link, Large.....	91	Sling - Webbing Material, Polyester.....	230
Pear, Weldless Sling.....	90	Sling - Web, Polyester.....	228, 229
Ring - Round, Weldless.....	91	Sling - Wire Rope, Bright, With A1 Light Lube.....	219, 220
Rov Locking Clamp Release Bow, Polar, With Green Pin®.....	68	Sling - Wire Rope, Galvanized.....	221-223
Rov Spring Release Bow, Polar, With Green Pin®.....	67	Wire Rope Sling Charts.....	224
Shackle - Warnings And Applications.....	69	Tool - Bolt Cutter.....	159
Sling Protector, With Safety Bolt, GN®.....	60	Tool - Swager Cutter.....	158
Super Bow, Anchor, With Safety Bolt Green Pin®.....	65	Tool - Wire Cutter.....	158
Swivel - Bullet Style, Angular Contact Bearing.....	99	Jiangsu Langshan Wire Rope Co. Ltd. The Worlds Largest Wire Rope Factory.....	291
Swivel - Closed Body Swivel, GN®.....	100	Oceanside Equipment Ltd, Exclusive Canadian Dealer for Jiangsu Langshan Wire Rope Co. Ltd., The Worlds Largest Wire Rope Factory.....	290
Swivel - Eye & Eye.....	94, 96	Sea Lube Wire Rope Lubricant.....	289
Swivel - Eye & Eye, Angular Contact Bearing.....	97	Wire Rope - 6x19, Bridle Wire, Fiber Core, Galvanized.....	296
Swivel - Eye & Eye, With Hardened Wearing Ring.....	96	Wire Rope - 6x19, Steel Core, Galvanized.....	298
Swivel - Flex, Eye & Eye.....	97	Wire Rope - 6x19, Steel Core, Galvanized & Greased.....	298
Swivel - Jaw & Eye.....	95	Wire Rope - 6x19, Trawl Warp, Fiber Core, Galvanized & Greased.....	296
Swivel - Jaw & Jaw, Angular Contact Bearing.....	99	Wire Rope - 6x24, Fiber Core, Galvanized.....	297
Swivel - Short Bow.....	96	Wire Rope - 6x25, Trolley & Hoists Rope, Fiber Core, Bright & Greased.....	305
Turnbuckle - Bottle Type (Closed) Galvanized.....	75	Wire Rope - 6x26, Regular Swaged Ws, Steel Core, Bright & Greased.....	297
Turnbuckle - Eye & Eye, Galvanized.....	72	Wire Rope - 6x26, Steel Core, Bright & Greased.....	299
Turnbuckle - Eye & Eye, Lashing.....	76	Wire Rope - 6x26, Steel Core, Galvanized.....	301
Turnbuckle - Heavy Duty, GN®.....	78	Wire Rope - 6x36, Steel Core, Galvanized.....	302
Turnbuckle - Hook & Hook, Galvanized.....	73	Wire Rope - 6x36, Steel Core, Galvanized & Greased.....	299
Turnbuckle - Jaw & Eye, Galvanized.....	74	Wire Rope - 6x37, Fiber Core, Bright & Greased.....	304
Turnbuckle - Jaw & Jaw, Bottle Type (Closed) Stainless Steel.....	75	Wire Rope - 7x7, 7x19, 6x19, 6x26, Steel Core, Stainless.....	294
Turnbuckle - Jaw & Jaw, Galvanized.....	70	Wire Rope - 7x7 & 7x19, Aircraft Cable, Pvc Coated, Steel Core, Galvanized.....	293
Turnbuckle - Jaw & Jaw, Stainless Steel.....	76	Wire Rope - 7x7, 7x19, Aircraft Cable, Pvc Coated, Steel Core, Stainless.....	295
Turnbuckle - Stub End.....	77	Wire Rope - 7x7 & 7x19, Aircraft Cable, Steel Core, Galvanized.....	292
Turnbuckle - Stub End, Body Only.....	77	Wire Rope - 8x19, Seale, Iwrc 1960 N/Mm2, Galvanized, A-2 Lube.....	309
Water Bags, Crane.....	114	Wire Rope - 8x26, Boom Rope, Bright & Greased.....	303
Water Bags, Crane Certification Fluid Weight.....	113	Wire Rope - 8x36, Seale, Iwrc 1960 N/Mm2, Galvanized, A-2 Lube.....	309
Water Bags, Lifeboat.....	114		
Wide Body Sling, With Safety Bolt Green Pin®.....	59		
Wide Body Sling, With Safety Bolt, Yoke® Brand.....	59		
Wide Mouth Bow, With Safety Bolt Green Pin®.....	66		
Fid - Norwegian.....	251		
Rope - Dsm Dyneema, 8 & 12-Strand.....	235		
Rope - Dsm Dyneema, 12-Strand.....	236		
Rope - Manila, 3-Strand.....	233		
Rope - Manila, 4-Strand.....	242		
Rope - Nylon, 3-Strand.....	244		
Rope - Nylon, 8-Strand.....	243		
Rope - Nylon Double Braided 2-1, Ocean Steel Line.....	247		
Rope - Nylon, Jumbo, 3-Strand.....	245		

INDEX A -Z

Wire Rope - 18x19s, Rotation Resistant, Steel Core, Bright & Greased.....	304
Wire Rope - 19x7, Rotation Resistant, Steel Core, Bright & Greased.....	304
Wire Rope - 35x7, Compacted, Hoist Rope, Bright & Greased.....	306, 307
Wire Rope - 35x7, Compacted, Non-Rotating, Steel Core, Galvanized & Greased.....	308
Wire Rope - 35x7, Compacted, Non-Rotating, Steel Core, Galvanized & Greased.....	307
Cable Joiner - Self-Locking.....	273
Choker Button.....	272
Clips Wire Rope 'Ocean' - Warnings and Application Instructions.....	276
Clip - Wire Rope, Forged.....	275
Clip - Wire Rope, Malleable.....	274
Clip - Wire Rope, Stainless.....	274
Die Lube - Swaging Lubricant.....	259
Fast Flemish Swage System.....	255
Go-No-Go Guages - For Flemish Eye Steel Sleeves (Ferrules).....	272
Hook - Micro Midget Choker.....	272
Marlin Spike.....	266
Reeling Machines Wirop Shaftless.....	265
Resin Socketing Warning And Safety Information.....	285
Rigging Equipment.....	254
Sleeve (Ferrule) - Aluminium.....	262
Sleeve (Ferrule) - Aluminium Duplex.....	263
Sleeve (Ferrule) - Aluminium Stop.....	263
Sleeve (Ferrule) - Button Stop.....	270
Sleeve (Ferrule) - Copper Oval.....	264
Sleeve (Ferrule) - Copper Stop.....	262
Sleeve (Ferrule) - Duplex Oval.....	265
Sleeve (Ferrule) - Flemish Splice, Carbon Steel.....	260
Sleeve (Ferrule) - Stainless Steel Duplex.....	265
Sleeves (Ferrules) Size Number Table A.2.....	261
Socket - Clipinator Wedge Socket.....	286
Socketing Putty.....	282
Socket Lock - Resin.....	282
Socket - Spelter, Closed, Forged, Ocean.....	277
Socket - Spelter, Closed, GN®.....	280
Socket - Spelter, Cr, Closed (Peewee, Gold Nose), GN®.....	281
Socket - Spelter, Open, Forged, Ocean.....	277
Socket - Spelter, Open, GN®.....	278, 279
Socket - Swage, Closed, Forged.....	284
Socket - Swage, Open, Forged.....	285
Solid Thimble - Din 3091.....	271
Swaging Machine New-Tech "Smart Press".....	260
Swaging Machines From 150 Te To 4,000 Te.....	258
Thimble - Heavy Duty.....	267, 269
Thimble - Light Duty.....	268, 269
Thimble - Synthetic Rope.....	271
Thimble - Tube.....	270
Wedge Socket Warnings And Use.....	287
Wire Rope Broom Degreaser.....	282



CONDITIONS OF SALE

Right to Inspect:

In the event of the Buyer making a claim against the Company for any reason whatsoever the goods in respect of which any such claim is made shall be preserved intact where delivery for a period of seven days from the notification of the claim to the Company within which time the Company shall have the right to attend at the place where the goods were delivered to investigate the complaint. No claim by the Buyer will be accepted unless this condition is strictly complied with.

Design Changes:

The company reserves the right to effect design changes as technical developments may require without prior notice.

Specifications Provided by Buyer:

The buyer shall indemnify the Company against any and all liability arising through execution by the Company of any order placed by a buyer in accordance with the Buyer's specification where such execution infringes any patent, trademark, or registered design not owned by the buyer or the Company.

Risk, Property and Insurance:

1. Goods supplied by the Company shall be at the Buyer's risk immediately on delivery to the buyer or into custody on the buyer's behalf (whichever is the sooner) the buyer should therefore arrange insurance accordingly unless the Company has specifically agreed to arrange insurance of the goods.
2. The property in the goods supplied by the Company will pass to the buyer when (1) the goods the subject of the Contract in question and (2) all other goods the subject of any contract between the Company and the buyer which have been delivered to the buyer (prior to the payment in full for the goods the subject of the contract in question) have been paid in full.
3. In the event that the buyer resells or hires out goods supplied by the Company (either in the original form, or after alterations by the buyer and/or after they have been added to an item manufactured by the buyer) prior to the passing of the property therein to the buyer such resale or hire shall be effected by the buyer as bailee for the Company and the proceeds of such sale or hire shall be held on trust for the Company in a separate bank account opened by the buyer for this purpose and these proceeds shall be received by the buyer for and on behalf of the Company unless all debts owing to the Company by the buyer in respect to the goods supplied by the Company have been paid.
4. So long as the property and goods remain the Company and the buyer is in default of such obligation hereunder the Company shall have the right, with or without prior notice to the buyer, to take possession of the goods and for that purpose to go onto any premises occupied by the buyer) and on such retaking of possession the contract shall be deemed to have been determined without prejudice to any claim or rights the Company might otherwise make or exercise.
5. Until payment due under all contracts between the Company and buyer has been made in full the buyer shall hold upon trust for the Company the goods (either in their original form, or after alterations by the buyer and /or after they have been added to an item manufactured by the buyer) and shall in so far as may be possible store them in such a way as they may be identifiable as the property of the Company and separate from all other goods in the buyers possession.
6. Until payment due under all contracts between the buyer and the Company has been made in full the Company shall be entitled to trace all proceeds of sale or hire charges received by the buyer on sale of the goods (either in their original form or after alteration by the buyer and/or after they have been added to an item manufactured by the buyer) received by the buyer through any bank or other account maintained by the buyer and the buyer will provide every assistance free of charge to the Company for the same.
7. Until payment due under all contracts between the buyer and Company has been made in full if the buyer sells or hires the goods (either in their original form or after alteration by the buyer and /or after they have been added to an item manufactured by the buyer) in the ordinary course of its business the buyer shall assign its rights to recover the selling price or hire charges from the third parties concerned to the Company if required to do so in writing by the Company.
8. Every insurable risk shall pass to the buyer as soon as the goods are delivered to it or into custody on its behalf. The buyer shall keep the goods insured in the amount of the price at which the goods are sold to the buyer against all insurable risks until payment due under all contracts between the buyer and Company has been made in full.
9. Of goods (either in their original form or after alteration by the buyer and/or after they have been added to an item manufactured by the buyer) are destroyed by an insured risk to the same being paid for by the buyer the buyer shall receive the proceeds of any such insurance as trustee for the Company.

Cancellation:

Once a contract has come into being between the Company and the buyer, that contract can not be cancelled only with the consent of the Company and upon terms that will indemnify it against loss. The buyer will indemnify the Company for all of the Company's contractual losses and the Company will not be under a duty to mitigate those losses.

Dispatch Abroad:

Goods dispatched abroad shall be deemed to have been inspected by the Buyer's agent or representative prior to dispatch from the Company's as no responsibility can be accepted by the Company after goods are consigned for shipment and the Company shall be under no obligation to give the buyer the notice specified.

Literature:

Illustrations, weights, measures, performance capabilities, application suitability information and other data set out in the sales literature of the Company are statements of opinion and are provided for information only and form no part of the contract.

Law of Contract and Jurisdiction:

All contracts for the supply of goods by the Company shall be governed by English Law and be within the exclusive jurisdiction of the Nova Scotia Courts.

Definition:

In these conditions "the Company" means the company upon whose document these conditions are endorsed.

General:

1. All quotations are made and all orders are accepted subject to the following conditions. All other conditions whatsoever are excluded from the contract or any variation thereof, unless expressly accepted by the Company in writing.
2. Acceptance of delivery of the goods shall where no prior agreement has been reached be conclusive evidence of acceptance of these conditions.
3. Quotations shall only be available for acceptance for a maximum period of 10 days from the date thereof and may be withdrawn or altered by the Company with in such period at any time without notice.

CONDITIONS OF SALE

4. Goods sold from stock are offered subject to the same being unsold upon receipt of the order.
5. The goods are subject to specifications (including dimensions, weights, analyses and properties) stated expressly in the contract or where none is specified, to the specification published by the company or where none is published to any relevant standards or code of practice.
6. Any typographical, clerical or other error or omission in any sales literature, quotation, price list, acceptance of offer, invoice or other document or information issued by the Company shall be subject to correction without any liability on the part of the Company.
7. The buyer shall not be entitled to retain any more money due to the Company under a contract unless previously agreed in writing by the Company's authorized representative.

Delivery:

Any date named by the Company for dispatch or delivery is given and intended as an estimate only and is not to be of the essence of the Contract. The buyer shall nevertheless be bound to accept the goods ordered whether available on or after the date stated. The Company shall be not be liable in any way in respect of late dispatch or delivery however caused nor shall failure to dispatch be deemed to be a breach of the Contract. Where drawings, specifications, instructions and materials are to be supplied by the buyer, the buyer shall supply the same in reasonable time to enable the Company to dispatch within the period named. The Company may, at its discretion, make installment deliveries and each delivery shall constitute a separate order for the purpose of payment.

Damage or Loss in transit:

No claim for damage or corrosion in transit or shortage of delivery of goods will be entertained unless a separate notice in writing is given to the Company and /or the carrier concerned within three days of receipt of the goods followed by a complete claim in writing to the Company within five days of receipt of the goods.

Non delivery:

No claim for loss or non-delivery of goods will be entertained unless in writing is received within seven days of the invoice date.

Storage:

The Company reserves the right to charge for storage and /or any other costs incurred in the event of deferment or delay in delivery at the request and /or action of the Buyer.

Prices:

The Company reserves the right to increase any prices agreed between the Company and the Buyer in accordance with market conditions and the company's price for similar goods ruling at the date of dispatch and the buyer shall pay such additions in addition to the quoted price. Without prejudice to the generality of the foregoing market conditions shall included any increases in the cost of labor, materials, transport and any other costs between quotation and dispatch.

HST and GST Taxes:

All taxes will be charged at the rate applicable at the date of dispatch. The quoted prices do not include any taxes.

Carriage and Packaging:

The cost of carriage and packaging shall be paid for by the customer in addition to price payable for the goods, unless agreed beforehand between the customer and the Company.

Terms of Payment:

1. Terms of payment are that invoices must be settled in full within 30 days from the date of the invoice.
2. If the buyer fails to make any payment on the due date then, without prejudice to any other right or remedy available to the Company, the Company shall be entitled to: (a) Cancel the contract and suspend any further deliveries to the buyer, (b) Appropriate any payment made by the buyer to such of the goods (as goods supplied under any other contract between the buyer and the Company) as the Company may think fit. (c) Charge the buyer interest (both before and after any judgment) on the amount unpaid, at the rate of 10% per annum over the base lending rate of the Company's own bankers, until payment in full is made (a part of a month being treated as a full month for the purpose of calculating interest).

Defective and Damaged Goods:

No claim against the Company for goods represented by the defective, from whatever cause, or not to conform to the Contract can be entertained, and the Company shall incur no liability in respect thereof unless received by the Company in writing within twenty-eight days after the date of dispatch and the defective goods or goods failing to conform to contract are returned to the Company within the said period of twenty-eight days.

Returns and Refunds:

1. Items that are obsolete or Specially Engineered product are not returnable.
2. Oceanside reserves the right to decline any request for a Returned Goods Authorization.
3. Proof of purchase must be established on all returned items. A valid purchase order number is required provided at time of request.
4. Oceanside will not accept the return of merchandise purchased over 60 days from receipt date.
5. The price shown on the Request for Return must coincide with the original invoice price.
6. Oceanside's Order Number and Invoice Number should be furnished at time of request to expedite the processing of Returned Goods Authorization forms.
7. After authorization is received, all returns must be shipped to the designated location.
8. Any material returned without authorization will be subject to an additional handling charge.
9. Returned Goods Authorization will be valid for 30 days from date of issue.
10. The greater of a 20% restocking fee or \$50.00 restocking charge will apply to all authorized returned merchandise. There will be no outbound freight chargeback; however, the customer will be responsible for in-bound freight charges.
11. All returned merchandise will be subject to inspection, and must be in resealable condition upon receipt. Any products returned within the guidelines of this policy or for inspection that is deemed non-Oceanside or non-resealable is subject to rejection or additional fees.

Limit of Liability:

In the event of any claim against the Company in respect of any matter whatsoever the Company's liability (if any) shall be limited to the replacement of goods sold in respect of which the liability arises if required and practicable or the buyer shall be given a credit for the invoiced value of the order in respect of which the liability arises. Under no circumstances whatsoever shall the Company be liable for any consequential loss or damage or any personal injury or damage or loss of any property other than as stated herein howsoever and whatsoever arising. Any express or implied conditions, statement, warranty, statutory, or otherwise, are hereby excluded save where such exclusions are invalidated by statute. No claim by the Buyer shall be accepted as a reason for cancellation of the remainder of the order.

World Class Rigging Products

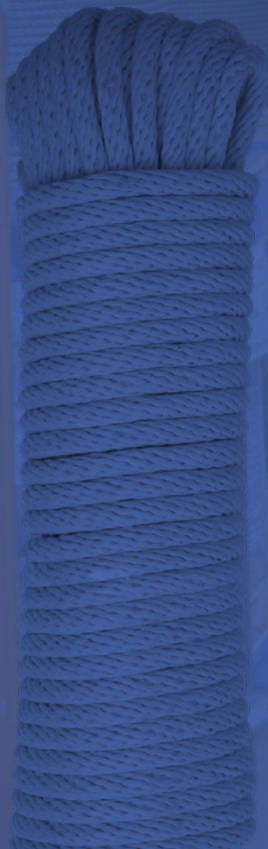

O C E A N S I D E



EQUIPMENT LIMITED

A BISHOP LIFTING COMPANY

Head Office:
Oceanside Equipment Limited
12-181 Joseph Zatzman Drive
Dartmouth, Nova Scotia
Canada, B3B 1R5

Newfoundland Office:
Oceanside Equipment Limited
111 Glencoe Drive, Mount Pearl
Newfoundland and Labrador
Canada, A1N 4S7

OceansideEquipment.ca